



# AccessTile<sup>®</sup>

Tactile Systems

**SURFACE APPLIED**

**Detectable Warning Surface Panels  
Submittal**



## SURFACE APPLIED *Innovative System*

Introducing the **Ultimate Solution™** in Tactile Walking Surface Indicators (TWSI). Access Tile® Surface Applied has combined proven engineered polymers, processing, and material technologies with innovative and intelligent design features to create the ultimate in tactile walking surface indicators.

Maximized efficiencies in manufacturing, materials sourcing, and product specifications deliver the most cost-effective solution in the industry. Access Tile truncated dome and wayfinding bar tiles are the industry leader for durability, weather, and wear resistance and are available as replaceable cast-in-place tiles and directional bars.

Tactile Walking Surface Indicators (TWSI) products for the following and many more applications:

- Curb Ramps
- Vehicular Passageways
- Parking Areas
- Top of Stair Landings / Wheelchair Ramps
- Pedestrian Crossings
- Escalator Approaches
- Transit Platforms
- Multi-Modal Transit Stations

### PRODUCT FEATURES

- A cost-effective method of retrofitting an existing curb ramp application
- A complete system is shipped with the tiles; adhesive and color match fasteners
- Beveled edges make for a smooth transition that meets Accessibility Codes
- Lightweight and easy to handle
- Easily cut to conform to various sizes and radius ramps
- Available as a standard radius tile
- Available in eight (8) different sizes to meet your needs
- Comes in six (6) standard colors
- 5-year manufacturer's warranty

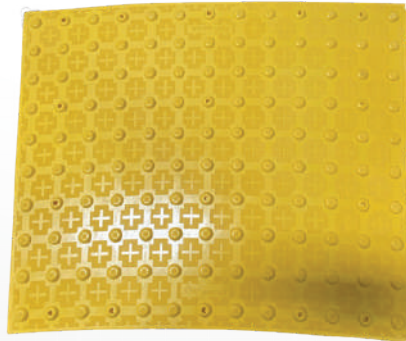
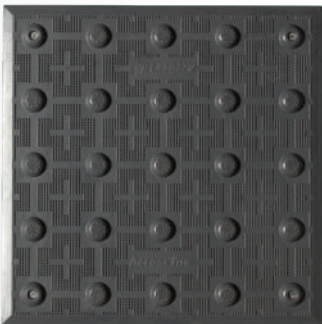

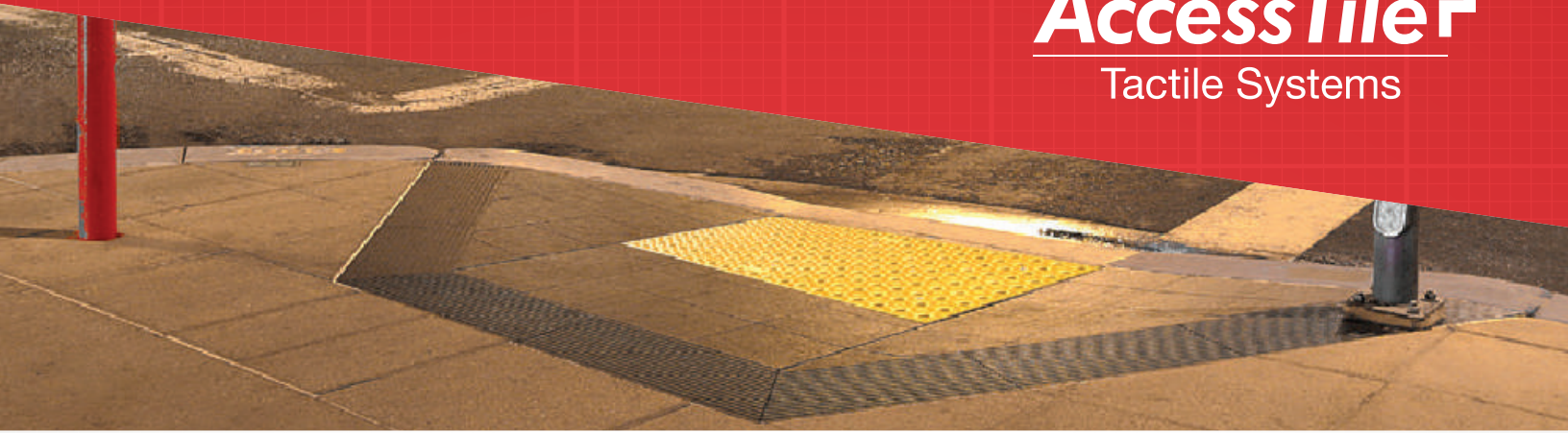

### TACTILE WALKING SURFACE INDICATOR (TWSI) WITH TRUNCATED DOMES

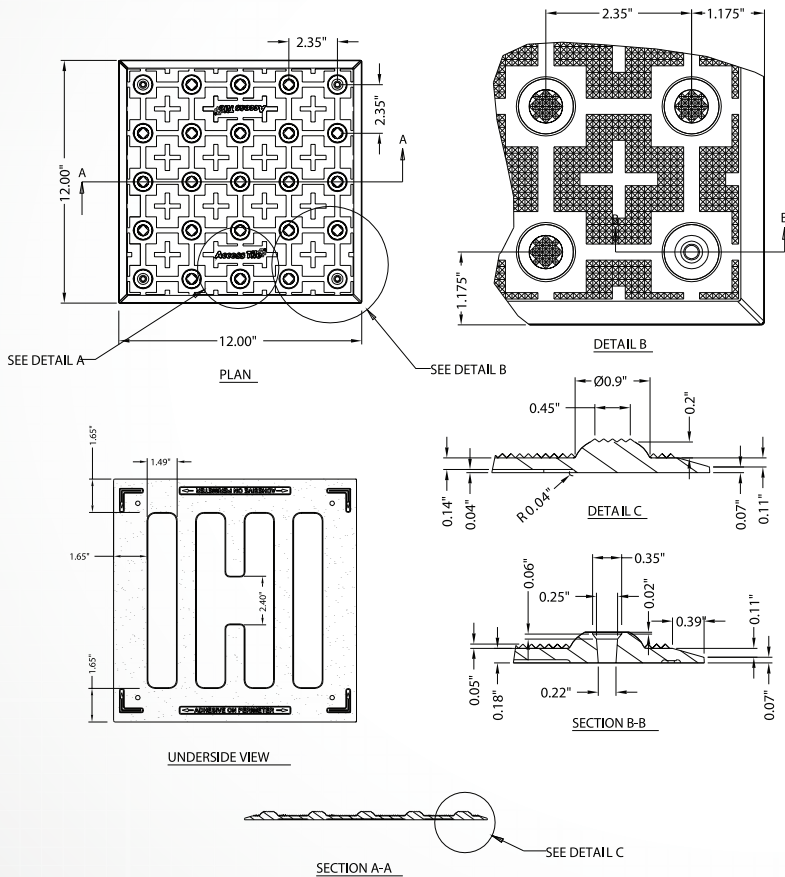

STANDARD DOMES SIZES	
SIZE	PRODUCT CODE
12" x 12" (305 x 305 mm)	ACC-S-1212
12" x 48" (305 x 1220 mm)	ACC-S-1248
24" x 24" (610 x 610 mm)	ACC-S-2424
24" x 36" (610 x 915 mm)	ACC-S-2436
24" x 48" (610 x 1220 mm)	ACC-S-2448
24" x 60" (610 x 1524 mm)	ACC-S-2460
36" x 48" (915 x 1220 mm)	ACC-S-3648
36" x 60" (915 x 1524 mm)	ACC-S-3660
RADIUS PANEL	
24" x 30" (610 x 762 mm)	ACC-S-2430CRV

### APPLICATIONS

#### TWSI Truncated Domes

- Curb ramps and blended transitions at pedestrian street crossings
- Pedestrian refuge islands
- Pedestrian at-grade rail crossings not located within a street or highway
- Boarding platforms at transit stops for buses and rail vehicles where the edges of the boarding platform are not protected by screens or guards
- Boarding and alighting areas at sidewalk or street level transit stops for rail vehicles where the side of the boarding and alighting areas facing the rail vehicles is not protected by screens or guards.



### STANDARD COLORS



### CUSTOM COLORS

Large variety available. Let us know how we can help.



## SECTION 32 17 26 - TACTILE WARNING SURFACE DETECTABLE WARNING SURFACE PANELS SURFACE APPLIED

### PART 1 - GENERAL

#### 1.1 RELATED DOCUMENTS

- A Drawings and general provisions of Contract, including General and Special Conditions and Division 1 Specifications Section, apply to this Section.

#### 1.2 DESCRIPTION

- A This Section specifies furnishing and installing Surface Applied Detectable Warning Surface Panels where indicated. Not recommended for asphalt applications.

#### 1.3 SUBMITTALS

- A Product Data: Submit manufacturer's literature describing products, installation procedures, and routine maintenance.
- B Samples for Verification Purposes: Submit two (2) samples minimum 12" x 12" (305 x 305 mm) of the kind proposed for use.
- C Shop drawings are required for products specified showing fabrication details, panel surface profile, fastener locations, plans of panel placement including joints, and material to be used as well as outlining installation materials and procedure.
- D Material Test Reports: Submit complete test reports from qualified accredited independent testing laboratories to qualify that materials proposed for use are in compliance with requirements and meet or exceed the properties indicated on the specifications.
- E Maintenance Instructions: Submit copies of manufacturer's specified installation and maintenance practices for each type of detectable warning surface panel.

#### 1.4 QUALITY ASSURANCE

- A Provide Surface Applied Detectable Warning Surface Panels and accessories as produced by a single manufacturer with a minimum of three (3) years experience in the manufacturing of tactile walking surface products.
- B Installer's Qualifications: Engage an experienced installer who has successfully completed installations similar in material, design, and extent to that indicated for Project.
- C Surface Applied Detectable Warning Surface Panels shall be compliant with the following guidelines and requirements (applicability may be dependent on project location):

##### 1. **APPLICABLE TO UNITED STATES**

- a. American Barriers Act (ABA) Accessibility Standards
- b. ADA Accessibility Guidelines (ADAAG)
- c. Department of Transportation ADA Standards for Transportation Facilities (2006)
- d. Department of Justice ADA Standards (2010)
- e. Public Rights-of-Way Accessibility Guidelines (PROWAG)
- f. California Building Standards Code, Title 24, California Code of Regulations
- g. Texas Accessibility Standards (TAS) 2012
- h. AASHTO M 333 Standard Specification for Detectable Warning Surfaces
- i. International Code Council (ICC) A117.1 Accessible and Usable Buildings and Facilities

**2. APPLICABLE TO CANADA**

- a. ISO 23599:2012(E): Assistive Products for Blind & Vision Impaired Persons – Tactile Walking Surf. Indicators
- b. CSA B651-18: Accessible Design for the Built Environment Standard – Section 4.3.5
- c. Integrated Accessibility Standards Regulation 191/11 – Sections 80.25 to 80.29
- d. Ontario Building Code 3.8.3.18. Tactile Attention Indicators
- e. National Building Code of Canada: Section 3.3.1.19 Tactile Walking Surface Indicators

D Surface Applied Detectable Warning Surface Panels shall be manufactured from fiberglass reinforced polymer composite. Panels shall incorporate the following design elements:

- 1. In-line pattern of truncated domes oriented parallel to panel edges
- 2. Dome height of 0.20" (5 mm)
- 3. Dome base diameter of 0.9" (23 mm)
- 4. Dome top diameter of 0.45" (12 mm)
- 5. Dome spacing of 2.35" (60 mm) to 2.40" (61 mm) center to center
- 6. Traction elements on top of domes and in the field between dome bases shall consist of a micro texture of raised points 0.05" high (1.2 mm)

E Surface Applied Detectable Warning Surface Panels shall meet or exceed the following test criteria using the most current test methods:

Test Method	Test Description	Value
ASTM D 695	Compressive Strength	≥ 28,900 psi (199.2 Mpa)
ASTM D 790	Flexural Strength	≥ 21,000 psi (144.7 Mpa)
ASTM D 638	Tensile Strength	≥ 11,000 psi (75.8 Mpa)
ASTM D 570	Water Absorption	≤ 0.05%
ASTM C 1028	Slip Resistance	≥ 0.80 wet/dry
ASTM E 84	Flame Spread Index	≤ 25
ASTM B 117	Salt Spray	No Effect
ASTM 1308	Chemical Stain	No Effect
ASTM C 501	Abrasion Resistance (lw)	> 500
ASTM G 155	Accelerated Weathering (2000hrs)	ΔE < 5
AASHTO-H20	Load Bearing at 10,410 lbs.	No Effect
ASTM C 1026	Freeze/Thaw/Heat	No Effect
ASTM D 1037	Accelerated Aging	No Effect

**1.5 DELIVERY, STORAGE AND HANDLING**

- A Surface Applied Detectable Warning Surface Panels shall be packaged to prevent damage in shipment or handling. Finished surfaces shall be protected by sturdy wrappings and products shall be identified by part number.
- B Surface Applied Detectable Warning Surface Panels shall be delivered to a location at the building site for storage before installation. Store panels in an area that is within an acceptable temperature range 40°F - 90°F (4°C - 32°C) and maintain the storage facility in a clean, dry condition to prevent contamination or damage to the panels.

## 1.6 SITE CONDITIONS

- A Environmental Conditions and Protection: Maintain minimum temperature of 40°F (4°C) in spaces to receive Surface Applied Detectable Warning Surface Panels for at least 24 hours prior to installation, during installation, and for not less than 24 hours after installation.

## 1.7 WARRANTY

- A Surface Applied Detectable Warning Surface Panels shall be warranted by the manufacturer in writing for a period of five (5) years from date of final completion. The guarantee includes manufacturing defects, breakage, and deformation.
- B Surface Applied Detectable Warning Surface Panel installation shall be warranted in writing for two (2) years by the installer. Products must be guaranteed from defective work and loosening of panels.

## PART 2 – PRODUCTS

### 2.1 MANUFACTURERS

- A. **Access Tile** Surface Applied Detectable Warning Surface Panels as manufactured by **SureWerx**, 325 Corporate Drive, Elgin, Illinois 60123. Phone 844-697-2920, [orders.ci.usa@surewerx.com](mailto:orders.ci.usa@surewerx.com), <https://accesstile.com/>
  - 1. Panel Sizes (nominal):
    - a. 12" x 12" (305 x 305 mm)
    - b. 24" x 24" (610 x 610 mm)
    - c. 24" x 36" (610 x 915 mm)
    - d. 24" x 48" (610 x 1220 mm)
    - e. 24" x 60" (610 x 1524 mm)
    - f. 36" x 48" (915 x 1220 mm)
    - g. 36" x 60" (915 x 1524 mm)
    - h. Factory Radius Panel 24" x 30" (610 x 762 mm) for installations with radius between 10 feet (3,048 mm) and 20 feet (6,096 mm)
  - 2. Color: Color shall be single, homogeneous color throughout panel and be close approximation of the following AMS-STD-595 color numbers:
    - a. Federal Yellow (YW), Color No. 33538
    - b. Brick Red (RD), Color No. 22144
    - c. Colonial Red (COL) Color No. 20109
    - d. Safety Red (SR) No. 31350
    - e. Onyx Black (BK) No. 17038
    - f. Dark Gray (G) No. 36118

## 2.2 MATERIALS

- A. Panel Composition: Surface Applied Detectable Warning Surface Panels shall be manufactured using an exterior grade homogeneous (uniform color throughout thickness of product) fiberglass reinforced polyester based composite material. Truncated domes must contain fiberglass reinforcement within the truncated dome for superior structural integrity and impact resistance. Use of tactile warning surface products employing colored coatings is expressly prohibited.
- B. Fasteners: Nylon sleeve stainless-steel low-profile expansion anchors 1/4 inch diameter by minimum 1-1/2 inch long as supplied by SureWerx with panels.
- C. Adhesive: Heavy duty elastomeric polyurethane adhesive by the following:
  - 1. Bostik Ultra-Set Advanced
  - 2. ChemLink M-1 Structural Adhesive/Sealant
  - 3. or approved equal

## PART 3 - EXECUTION

### 3.1 PREPARATION

- A. The concrete shall be poured and finished, true and smooth to the required dimensions and slope prior to Surface Applied Detectable Warning Surface Panel placement.

### 3.2 EQUIPMENT

- A. Contractor shall provide all tools, equipment, and services required for satisfactory installation per manufacturer's instruction as Incidental Work. Equipment which may be required include typical mason's tools, a 4-foot level with electronic slope readout, 25 lb. (11.4 kg) weights, and tools for cutting the Detectable Warning Surface Panels.

### 3.3 INSTALLATION

- A. Contractor will not be allowed to install panels until all submittals have been reviewed and approved by the Engineer. Panels shall be installed per manufacturer's instructions.
- B. To the maximum extent possible, the panels shall be oriented such that the rows of in-line truncated domes are parallel with the direction of the ramp. When multiple panels regardless of size are used, the truncated domes shall be aligned between the panels and throughout the entire tactile warning surface installation.
- C. In accordance with the Proposed Accessibility Guidelines for Pedestrian Facilities in the Public Rights of Way 2011, panels shall be located relative to the curb line as shown within Sections 304 and 305 of the Guidelines.
- D. Cutting of panels may be required to accommodate specific site conditions. All possible attempts shall be made to minimize cutting of the panels. Minimum acceptable width of the cut panel shall be 9".
- E. For proper curing of adhesive and sealant, air and substrate temperatures must maintain a minimum temperature of 40°F (4°C) for at least 8 hours after installation of panels.
- F. Verify that substrate is flat across application area of panel. Field grinding of concrete may be required to remove high spots and assure a flat substrate is achieved prior to panel installation.

- G. Prior to application of adhesive to concrete substrate, remove any residual contamination by mechanical abrasion, sand blasting, or power washing. On green concrete, remove all release agents, friable and loose concrete. Dry all visible and standing water prior to applying adhesive.
- H. Clean the bottom side of the panel with acetone on a clean rag. Wipe around the perimeter and along the internal cross pattern to remove any dirt or dust particles from the area to receive the adhesive.
- I. Apply minimum 3/8" (9.5 mm) bead of adhesive on the backside of panel continuous along both perimeter and interior flat frame surface.
- J. For superior adhesion and panel support in high traffic areas, a full coverage of adhesive may be desired
- K. Set the panel(s) true and square to the curb ramp areas as detailed in the Drawings. Allow 1/8" separation between successive panels for expansion/contraction.
- L. Drill 1/4" (6.35 mm) holes to a depth of 2" (50.8 mm) at all fastener locations provided in top of panel. Additional attachment locations may be required at the perimeter of cut panels or as needed to properly secure panel to substrate. Locate new holes through center of truncated domes using a 5 point 1/2" (12.7 mm) x 82 degree countersink drill bit.
- M. Mechanically fasten panels to the concrete substrate using manufacturer supplied composite sleeve anchors with stainless steel drive pins. Ensure that the fastener has been set to full depth, straight and true. Care should be taken when setting the fastener to avoid striking the surface of the panel.
- N. Apply a continuous bead of sealant around the perimeter edge the installed panel.
- O. Do not allow foot traffic on installed panel until the perimeter edge sealant has fully cured.

### **3.4 CLEANING AND PROTECTING**

- A. Protect panels against damage during construction period to comply with panel manufacturer's Specifications.
- B. Remove strippable protective film from panel within 24 hours of installation of the panel. Note that hot temperatures and excess exposure to sunlight can cause protective film to permanently adhere to panels surface.
- C. If requested by the Project Manager, clean panels not more than four (4) days prior to date scheduled for inspection intended to establish date of substantial completion in each area of project. Clean panel by method specified by Detectable Warning Surface panel manufacturer.

### **END OF SECTION**

1'X1'

**SURFACE APPLIED  
2.35" DOME SPACING**

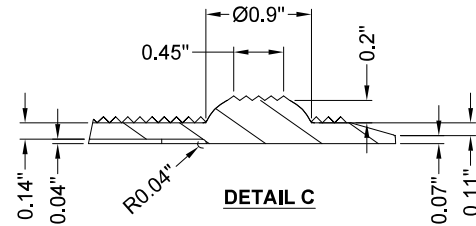
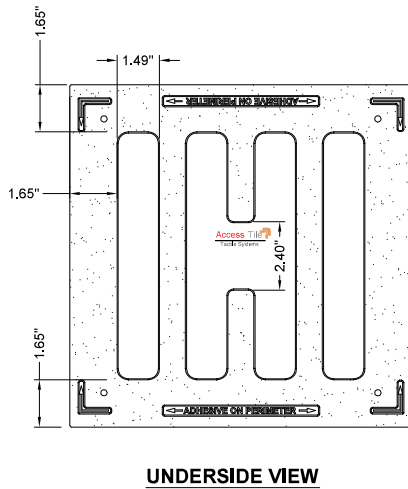
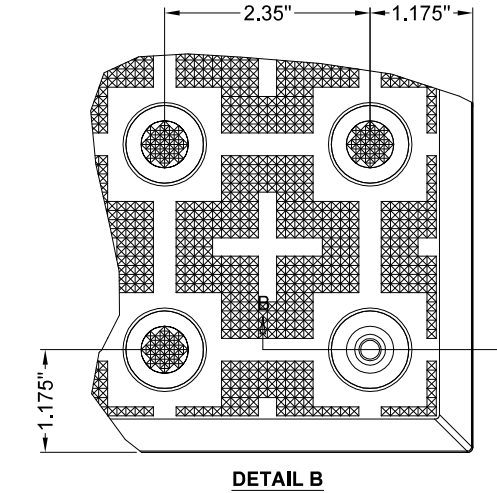
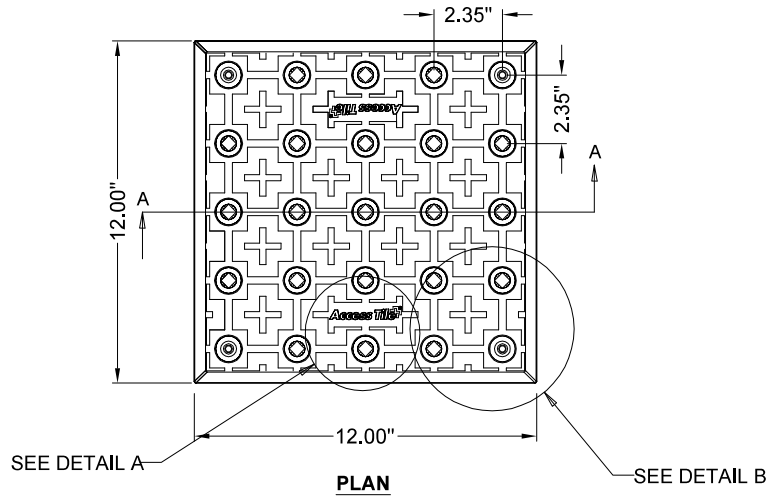

**UNDERSIDE VIEW**

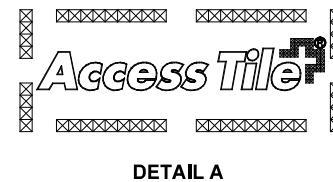
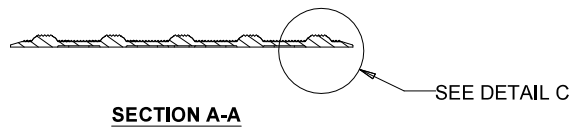
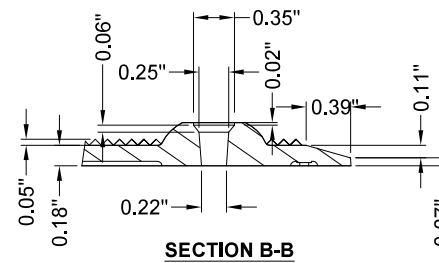

**Access Tile**

**SureWerx**

**MATERIAL LIST**

ITEM	DESCRIPTION	PART NO.	QTY
1	ACCESS TILE	ACC-S-1X1	1
2	Tek™ ANCHOR	ACC-S-ANCH	4
3	TACTILE BOND AND SEAL	TBS-010	1 ea

NOTE: FASTENERS ARE INCLUDED WITH TILE

**REFERENCE DRAWINGS**

DWG. NO.	DESCRIPTION

No.	DATE	REVISION	APPR.

SCALE 1"=1'-0" U.N.O. FULL SIZE ONLY

DESIGNED	DATE 10/09/2008
DRAWN	10/15/2008
CHECKED	

PROJECT MANAGER	
TRADE DETECTABLE WARNING SURFACE	PART NO. ACC-S-1X1

MATERIAL POLYMER COMPOSITE

SUBJECT **ACCESS TILE**  
TRUNCATED DOME, DETECTABLE WARNING TACTILE SURFACE

PROJECT **ACCESS TILE**  
TRUNCATED DOME, DETECTABLE WARNING TACTILE SURFACE  
1X1 SURFACE APPLIED  
INLINE DOME TILE DRAWING.

DRAWING NO. ACC-S-1X1	REV. NO. Ø
-----------------------	------------



2'X3'

**SURFACE APPLIED  
2.35" DOME SPACING**

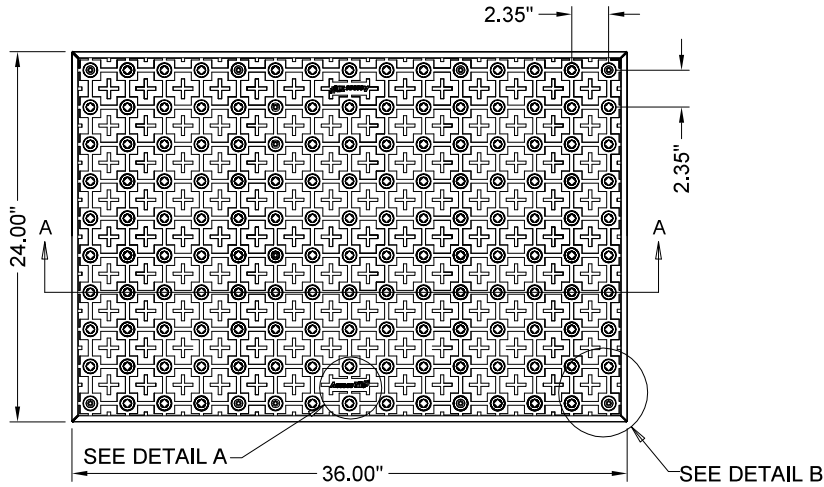

**PLAN**

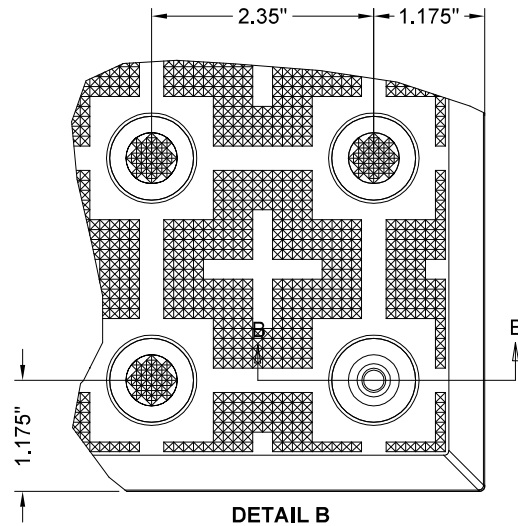

**DETAIL B**

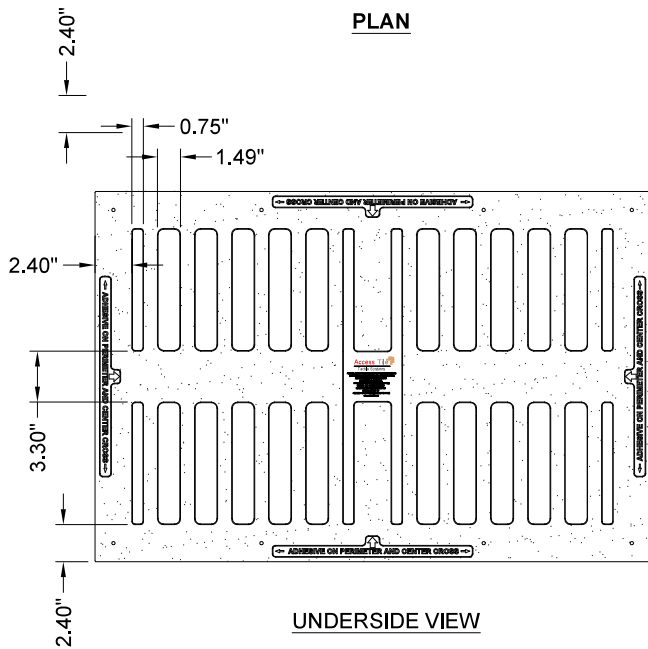

**UNDERSIDE VIEW**



**SECTION A-A**

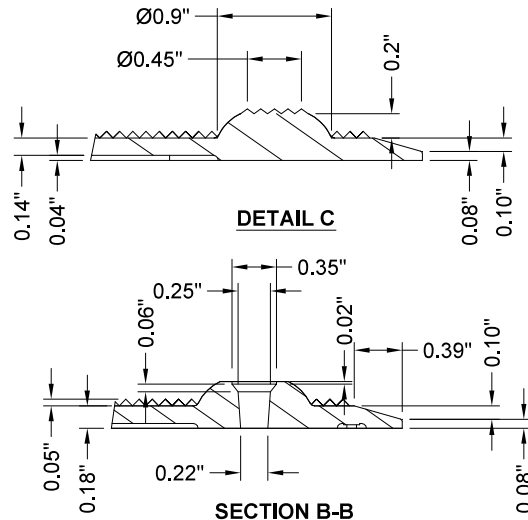

**DETAIL C**

**SECTION B-B**



**DETAIL A**



**MATERIAL LIST**

ITEM	DESCRIPTION	PART NO.	QTY
1	ACCESS TILE	ACC-S-2X3	1
2	Tek™ ANCHOR	ACC-S-ANCH B	B
3	TACTILE BOND AND SEAL	TBS-010	1 ea

NOTE: FASTENERS AND 1 TUBE OF TACTILE BOND AND SEAL ARE INCLUDED WITH TILT

**REFERENCE DRAWINGS**

DWG. NO.	DESCRIPTION

No.	DATE	REVISION	APPR.

SCALE N.T.S.

DESIGNED DATE 10/09/2008

DRAWN 10/15/2008

CHECKED

PROJECT MANAGER

TRADE DETECTABLE WARNING SURFACE PART NO. ACC-S-2X3

MATERIAL POLYMER COMPOSITE

SUBJECT **ACCESS TILE®**  
TRUNCATED DOME, DETECTABLE  
WARNING TACTILE SURFACE

PROJECT **ACCESS TILE®**  
TRUNCATED DOME, DETECTABLE  
WARNING TACTILE SURFACE  
2X3 SURFACE APPLIED  
INLINE DOME TILE DRAWING.

DRAWING NO. ACC-S-2X3 REV. NO. Ø

2'X4'

**SURFACE APPLIED  
2.35" DOME SPACING**

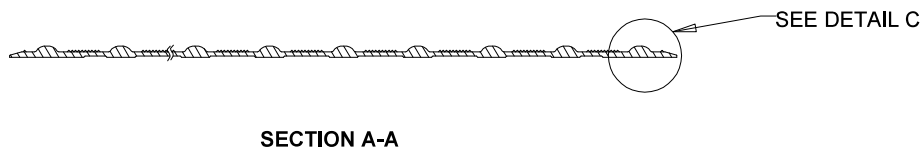
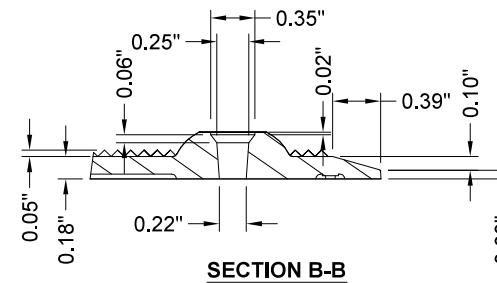
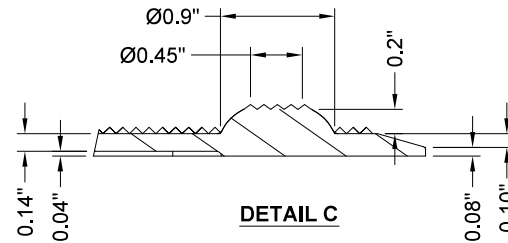
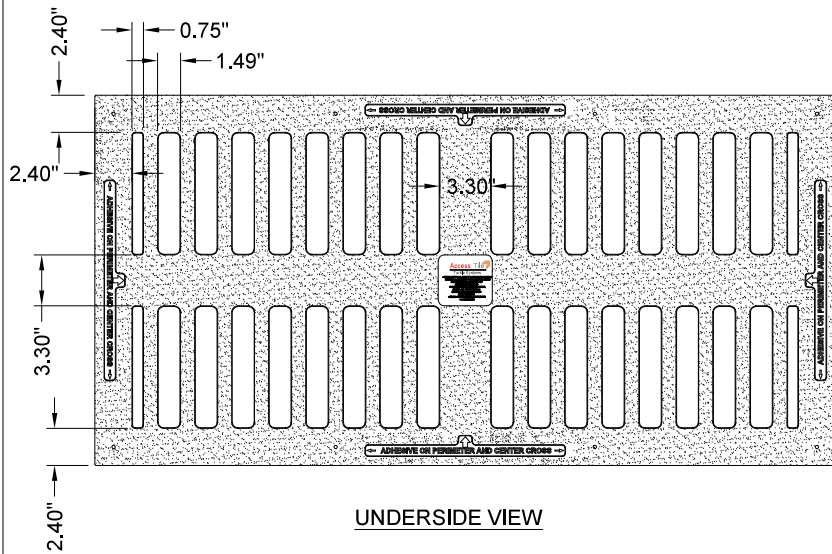
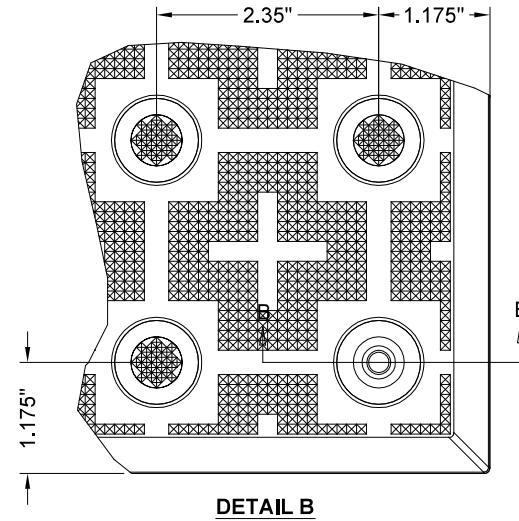
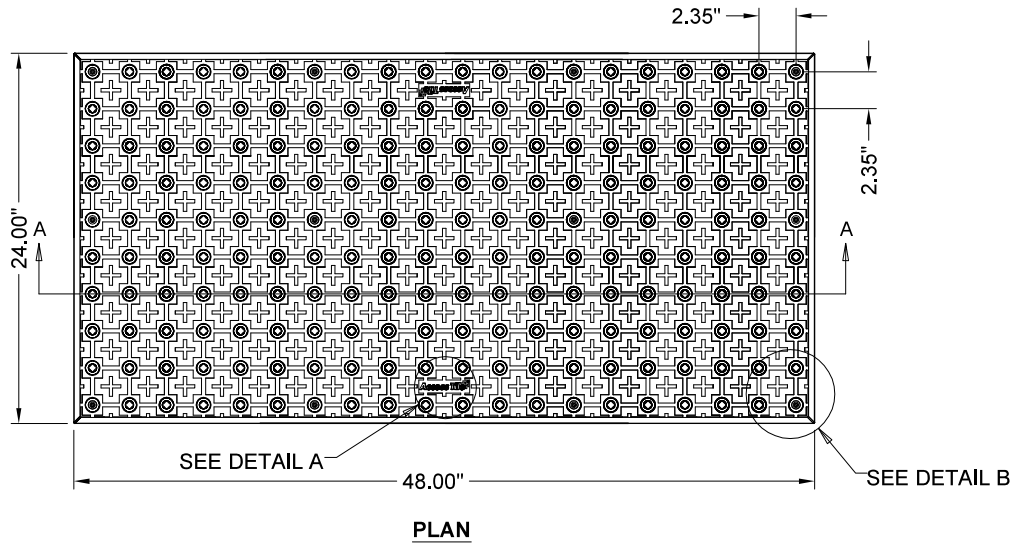

**Access Tile**

**SureWerx**

**MATERIAL LIST**

ITEM	DESCRIPTION	PART NO.	QTY
1	ACCESS TILE	ACC-S-2X4	1
2	Tek™ ANCHOR	ACC-S-ANCH	11
3	TACTILE BOND AND SEAL	TBS-010	1 ea

NOTE: FASTENERS AND 1 TUBE OF TACTILE BOND AND SEAL ARE INCLUDED WITH TILF

**REFERENCE DRAWINGS**

DWG. NO.	DESCRIPTION

No.	DATE	REVISION	APPR.

SCALE: N.T.S.

DESIGNED: DATE 10/09/2008

DRAWN: 10/15/2008

CHECKED:

PROJECT MANAGER:

TRADE: DETECTABLE WARNING SURFACE PART NO. ACC-S-2X4

MATERIAL: POLYMER COMPOSITE

SUBJECT: **ACCESS TILE®**  
TRUNCATED DOME, DETECTABLE WARNING TACTILE SURFACE

PROJECT: **ACCESS TILE®**  
TRUNCATED DOME, DETECTABLE WARNING TACTILE SURFACE  
2X4 SURFACE APPLIED  
INLINE DOME TILE DRAWING.

DRAWING NO. ACC-S-2X4 REV. NO. Ø

2'X5'

**SURFACE APPLIED  
2.35" DOME SPACING**

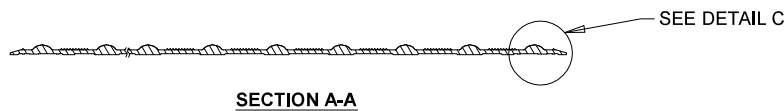
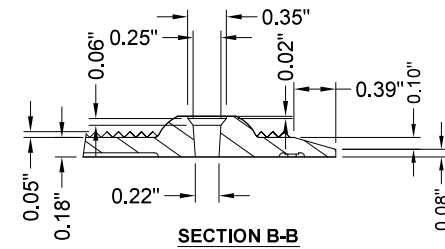
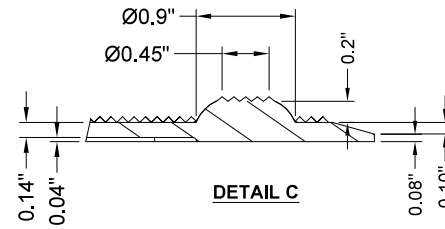
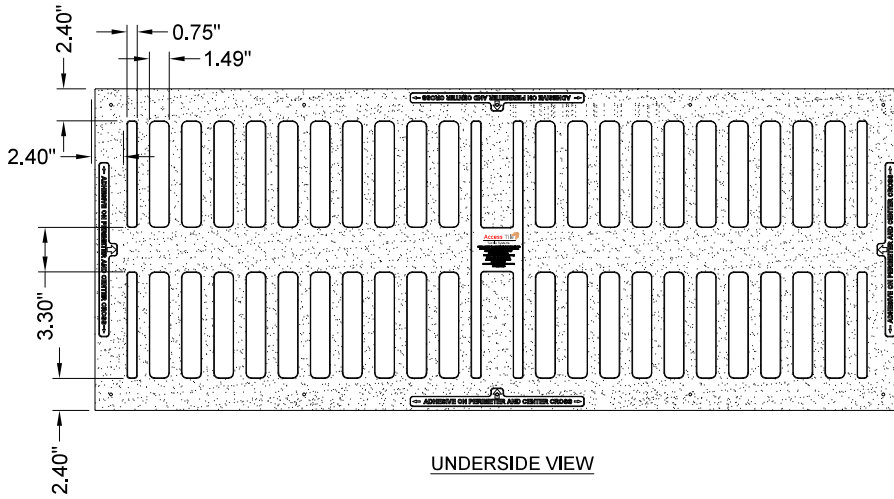
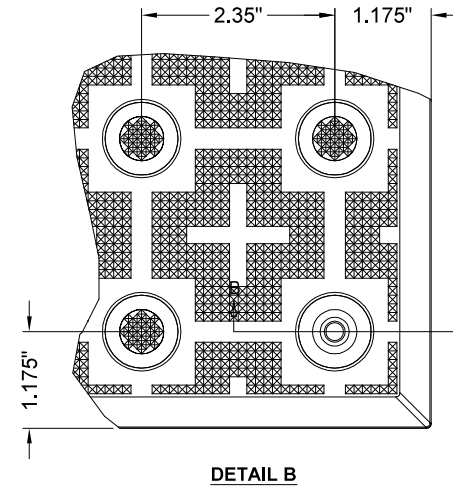
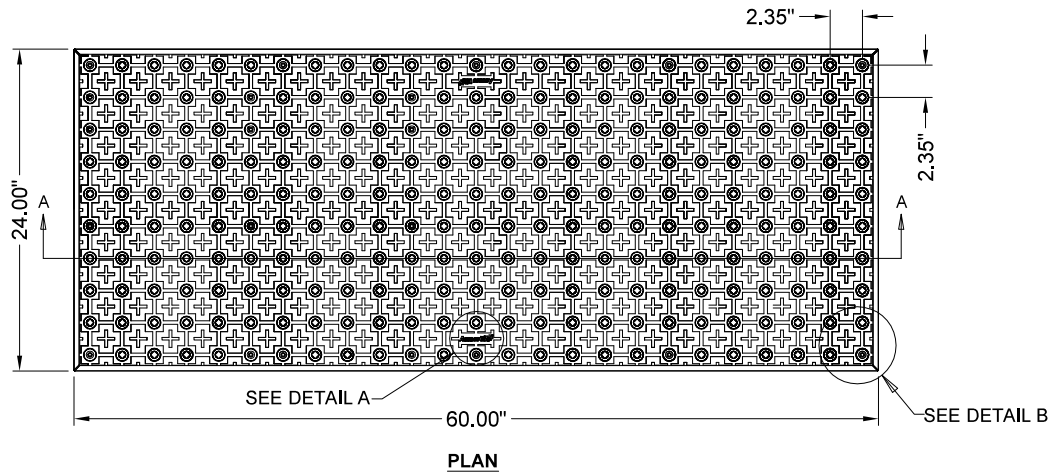

**Access Tile**

**SureWerx**

**MATERIAL LIST**

ITEM	DESCRIPTION	PART NO.	QTY
1	ACCESS TILE	ACC-S-2X5	1
2	Tek™ ANCHOR	ACC-S-ANCH	10
3	TACTILE BOND AND SEAL	TBS-010	1 ea

NOTE: FASTENERS AND 1 TUBE OF TACTILE BOND AND SEAL ARE INCLUDED WITH TILE

**REFERENCE DRAWINGS**

DWG. NO.	DESCRIPTION

No.	DATE	REVISION	APPR.

SCALE: N.T.S.

DESIGNED: DATE: 10/09/2008

DRAWN: 10/15/2008

CHECKED:

PROJECT MANAGER:

TRADE: DETECTABLE WARNING SURFACE PART NO. ACC-S-2X5

MATERIAL: POLYMER COMPOSITE

SUBJECT: **ACCESS TILE**  
TRUNCATED DOME, DETECTABLE WARNING TACTILE SURFACE

PROJECT: **ACCESS TILE**  
TRUNCATED DOME, DETECTABLE WARNING TACTILE SURFACE  
2X5 SURFACE APPLIED  
INLINE DOME TILE DRAWING.

DRAWING NO. ACC-S-2X5 REV. NO. Ø

3'X4'

**SURFACE APPLIED  
2.35" DOME SPACING**

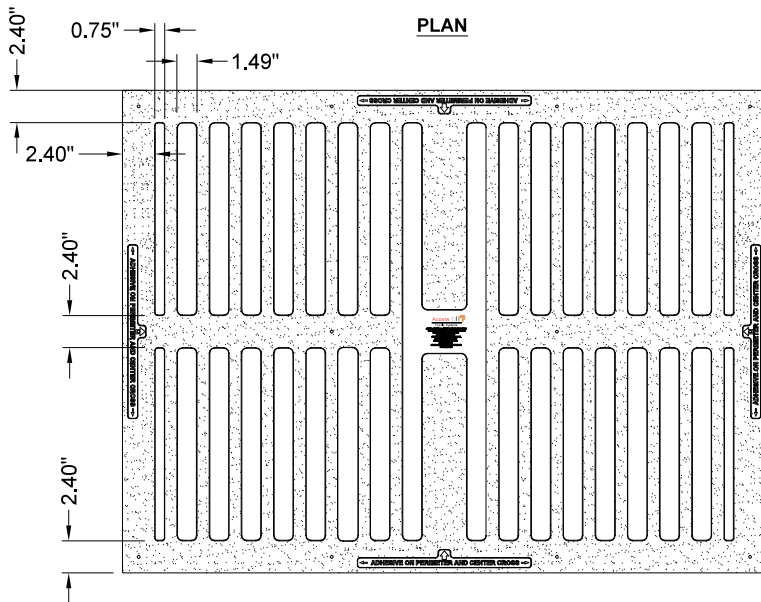
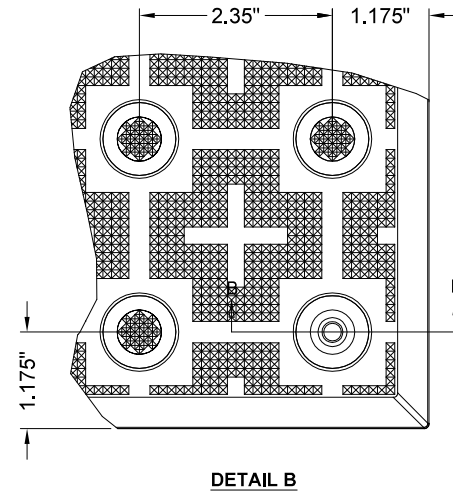
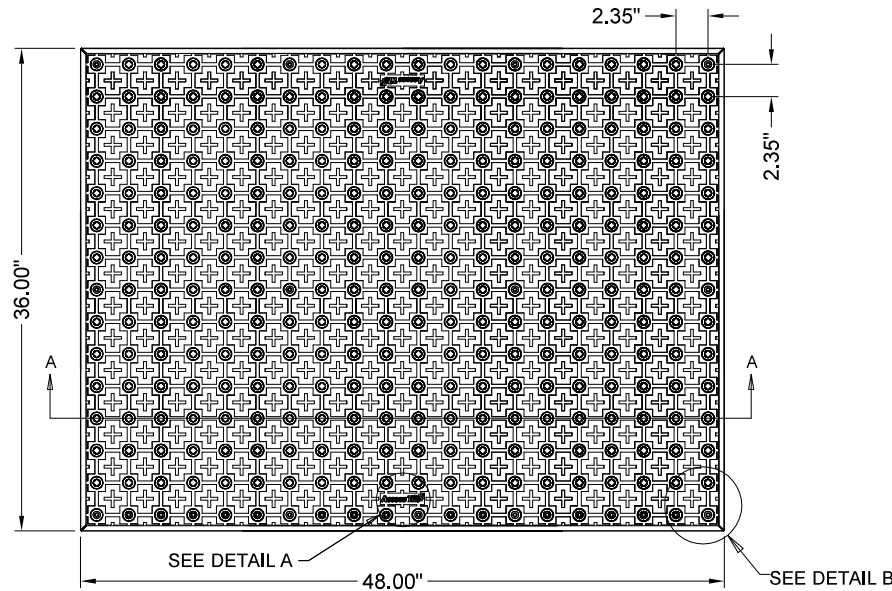

UNDERSIDE VIEW

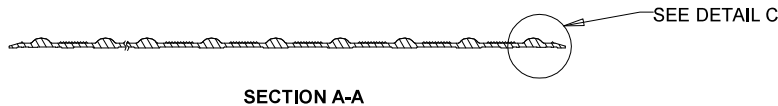

SECTION A-A

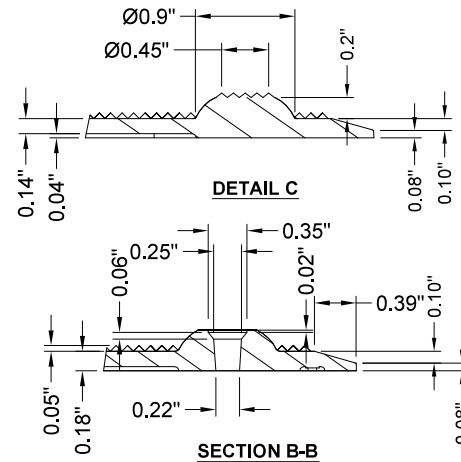

SECTION B-B



DETAIL A



MATERIAL LIST

ITEM	DESCRIPTION	PART NO.	QTY
1	ACCESS TILE	ACC-S-3X4	1
2	Tek™ ANCHOR	ACC-S-ANCH	12
3	TACTILE BOND AND SEAL	TBS-010	1 ea

NOTE: FASTENERS AND 1 TUBE OF TACTILE BOND AND SEAL ARE INCLUDED WITH TIL

REFERENCE DRAWINGS

DWG. NO.	DESCRIPTION

No.	DATE	REVISION	APPR.

SCALE N.T.S.

DESIGNED DATE 10/09/2008

DRAWN 10/15/2008

CHECKED

PROJECT MANAGER

TRADE DETECTABLE WARNING SURFACE PART NO. ACC-S-3X4

MATERIAL POLYMER COMPOSITE

SUBJECT **ACCESS TILE®**  
TRUNCATED DOME, DETECTABLE  
WARNING TACTILE SURFACE

PROJECT **ACCESS TILE®**  
TRUNCATED DOME, DETECTABLE  
WARNING TACTILE SURFACE  
3X4 SURFACE APPLIED  
INLINE DOME TILE DRAWING.

DRAWING NO. ACC-S-3X4 REV. NO. Ø

3'X5'

**SURFACE APPLIED  
2.35" DOME SPACING**

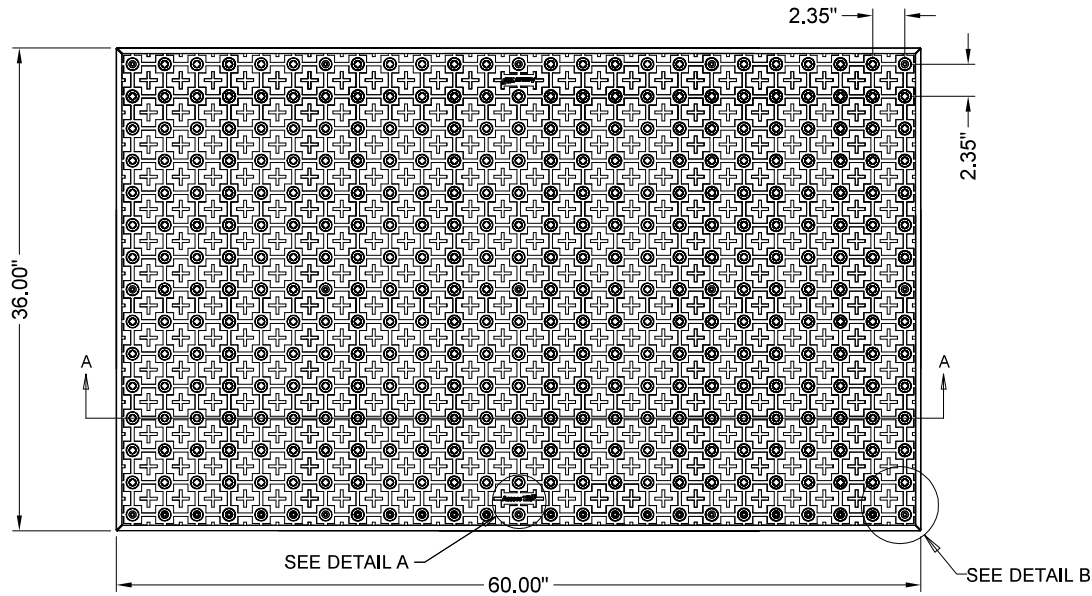

**PLAN**

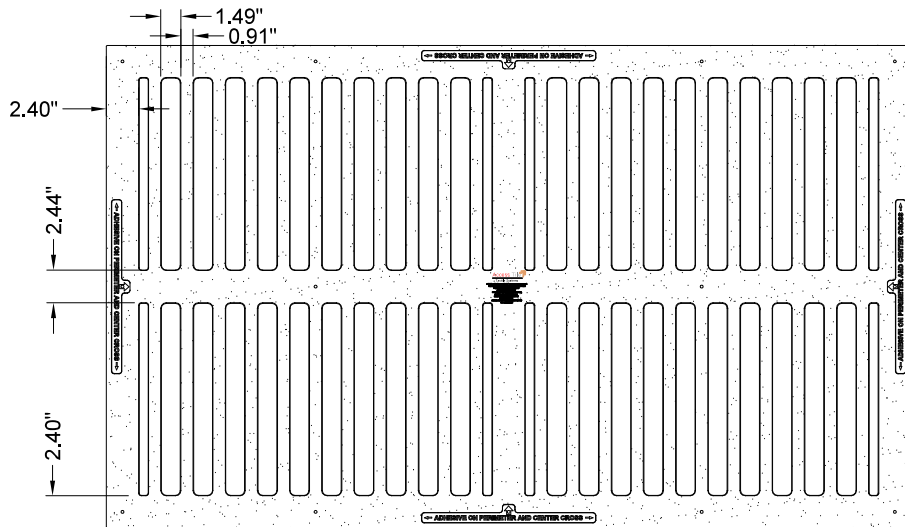

**UNDERSIDE VIEW**

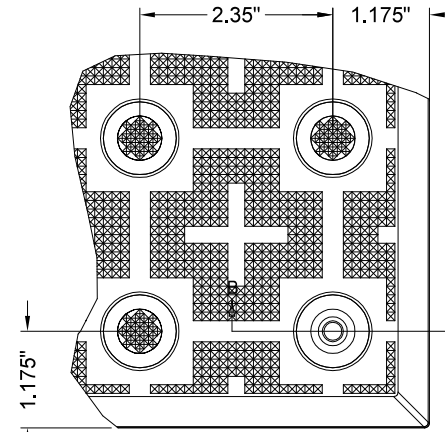
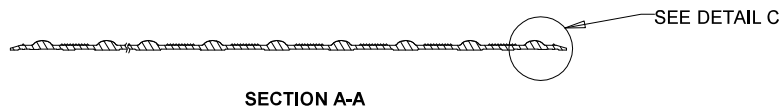

**DETAIL B**

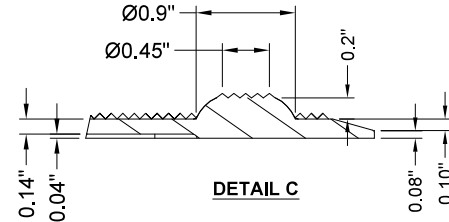

**DETAIL C**

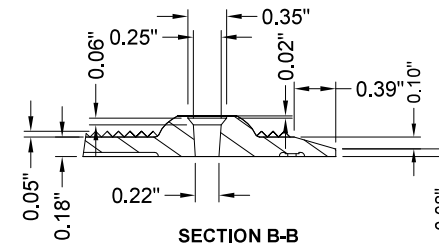

**SECTION B-B**



**MATERIAL LIST**

ITEM	DESCRIPTION	PART NO.	QTY
1	ACCESS TILE	ACC-S-3X5	1
2	Tek™ ANCHOR	ACC-S-ANCH	15
3	TACTILE BOND AND SEAL	TBS-010	1 ea

NOTE: FASTENERS AND 1 TUBE OF TACTILE BOND AND SEAL ARE INCLUDED WITH TIL

**REFERENCE DRAWINGS**

DWG. NO.	DESCRIPTION

No.	DATE	REVISION	APPR.

SCALE: N.T.S.

DESIGNED: DATE 10/09/2008

DRAWN: 10/15/2008

CHECKED:

PROJECT MANAGER:

TRADE: DETECTABLE WARNING SURFACE PART NO. ACC-S-3X5

MATERIAL: POLYMER COMPOSITE

SUBJECT: **ACCESS TILE®**  
TRUNCATED DOME, DETECTABLE WARNING TACTILE SURFACE

PROJECT: **ACCESS TILE®**  
TRUNCATED DOME, DETECTABLE WARNING TACTILE SURFACE  
3X5 SURFACE APPLIED  
INLINE DOME TILE DRAWING.

DRAWING NO. ACC-S-3X5 REV. NO. Ø

# CURVE

## SURFACE APPLIED 2.35" DOME SPACING

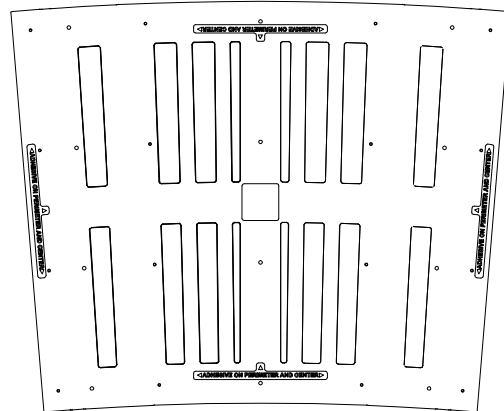
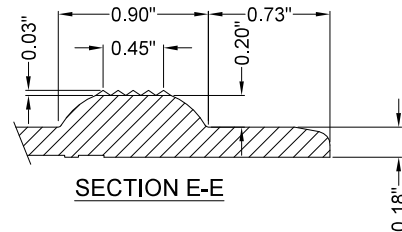
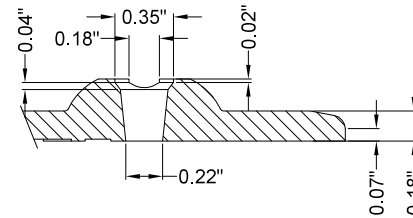
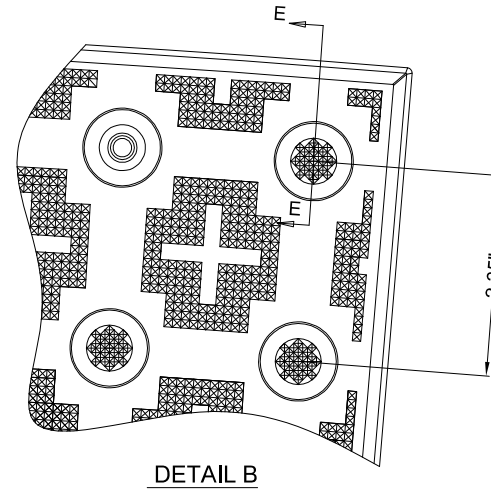
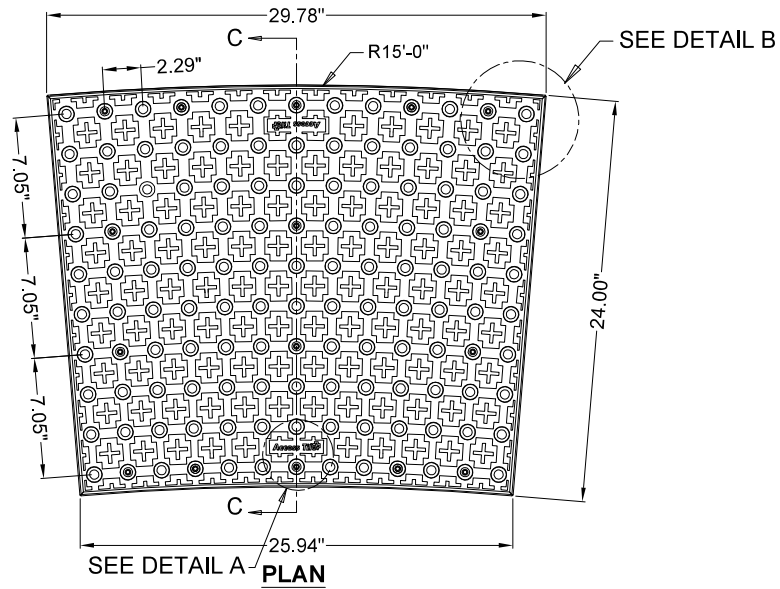

### MATERIAL LIST

ITEM	DESCRIPTION	PART NO.	QTY
1	ACCESS TILE	ACC-S-2X2CRV	1
2	Tek™ ANCHOR	ACC-S-ANCH	16
3	TACTILE BOND AND SEAL	TBS-010	1 ea

NOTE: FASTENERS AND 1 TUBE OF TACTILE BOND AND SEAL ARE INCLUDED WITH TILT

### REFERENCE DRAWINGS

DWG. NO.	DESCRIPTION

No.	DATE	REVISION	APPR.

SCALE 1"=1'-0" U.N.O. FULL SIZE ONLY

DESIGNED DATE 12/20/2013

DRAWN 06/26/2014

CHECKED

PROJECT MANAGER

TRADE DETECTABLE WARNING SURFACE PART NO. ACC-S-2X2CRV

MATERIAL POLYMER COMPOSITE

SUBJECT **ACCESS TILE®**  
TRUNCATED DOME, DETECTABLE  
WARNING TACTILE SURFACE

PROJECT **ACCESS TILE®**  
TRUNCATED DOME, DETECTABLE  
WARNING TACTILE SURFACE  
2X2 CURVED SURFACE APPLIED  
INLINE DOME TILE DRAWING.

DRAWING NO. ACC-S-2X2CRV REV. NO. Ø

## SURFACE APPLIED *Installation Instructions*

1. Place the tile on the designated location and trace the perimeter with a thin permanent marker.
2. Set the tile aside, and using a 4" diamond cup grinder, prepare the concrete within the marked location and in correspondence with the location requiring adhesive as indicated on the backside of the tile.
3. Clear away the dust with a leaf blower, then clean the back of the tile and the concrete with a rag soaked in acetone.
4. Apply Tactile Bond and Seal adhesive to the back of the tile (as indicated on the tile). The first bead should be applied thin, ½" from the perimeter edge, and a second thicker bead applied 1" inside of the first.
5. Set the tile true and square to the concrete and press down firmly.
6. While stepping down on either side of the preformed hole, drill down 3" into concrete using a hammer drill and the recommended diameter drill bit. Drill through the tile without the hammer option until the tile has been penetrated, then with the hammer option drill into the concrete.
7. While still applying pressure, remove the dust and any adhesive that surfaces and carefully set the supplied color-matched Axis® Fasteners with a plastic-tipped hammer. Repeat steps 6 & 7 while working across the tile from one end until all pre-formed fastener locations are completed.
8. Clean the perimeter of the tile and the immediately surrounding concrete with acetone, making sure to remove any adhesive that has escaped from beneath the tile. Apply a smooth sealant around the perimeter of the tile.
9. Tape all perimeter edges.
10. Apply Tactile Bond and Seal around the tile perimeter using care to work sealant into any void between the tile and concrete interface.
11. Tool perimeter sealant with a round plastic applicator or spatula to create a cove.
12. Remove tape immediately after tooling perimeter sealant.
13. DO NOT allow floor traffic until perimeter sealant has cured sufficiently to avoid tracking.

*Tiles can be cut to custom sizes, or to make a radius, using a continuous rim diamond blade in a circular saw or mini-grinder. Use of a straightedge to guide the cut is advisable where appropriate.*

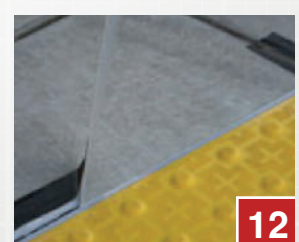
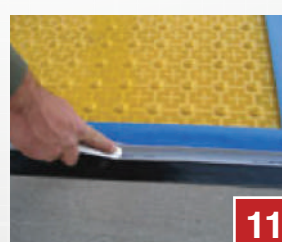
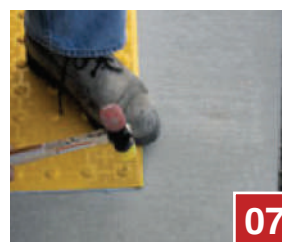
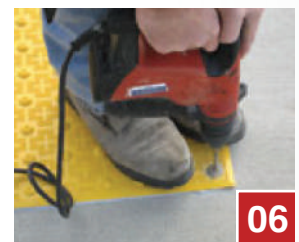
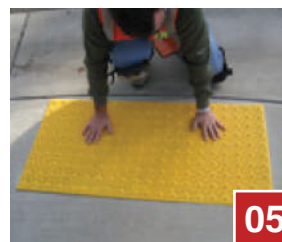
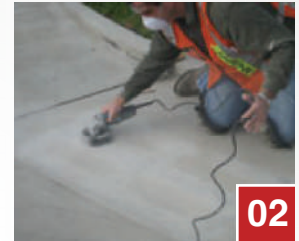



A SureWerx Brand

# Certificate of Compliance

Issued Date: **08/01/2024**

Issued To: **Company**

Project: **Project/Project Reference**

Manufacturer: **SureWerx (Access Tile, a SureWerx Brand)**

Product: **Surface Applied Detectable Warning Panels, Federal Yellow**

Description: **Fiberglass reinforced polymer composite material**

**SureWerx certifies that the above identified product is compliant with the following standards and guidelines:**

- Architectural Barriers Act (ABA 2015), Chapter 705 Detectable Warnings
- Department of Justice ADA Standards (2010), Chapter 705 Detectable Warnings
- Department of Transportation ADA Standards for Transportation Facilities (2006), Chapter 705 Detectable Warnings
- Pedestrian Right-Of-Way Accessibility Guidelines (PROWAG), Chapter R305 Detectable Warning Surfaces
- California Building Standards Code, Title 24 of the California Code of Regulations (Title 24) Chap 11B-705.1 Detect. Warnings
- International Code Council, 2017 ICC A117.1 Accessible and Usable Bldgs. and Facilities, Sect. 705 Detect. Warning Surfaces

**SureWerx certifies that the above identified product meets all the applicable specification requirements for Detectable Warning Surface for [State] Department of Transportation.**

**The identified product has been tested in accordance with the following test methods (Individual test results are available upon request. Contact SureWerx for additional information):**

- |   |                                       |
|---|---------------------------------------|
| • ASTM D695 Compressive Strength  | • ASTM D 638 Tensile Strength         |
| • ASTM C 1028 Standard Test Method for Determining the Static Coefficient of Friction (Slip Resistance) | • ASTM D1037 Freeze/Thaw              |
| • ASTM D570 Water Absorption  | • ASTM E84 Flame Spread Index         |
| • ASTM D790 Flexural Strength   | • ASTM C501 Abrasion Resistance       |
| • ASTM C1026 Freeze/Thaw/Heat   | • ASTM G155 Accelerated Weathering    |
| • ASTM-B117 Salt and Spray  | • ASTM D543 Chemical Stain Resistance |
|   | • AASHTO H20 Load Bearing Test        |

Issued by:

*John Stieby*

Name

*Director of End User Sales*

Title

*00/00/2024*

Date





A SureWerx Brand

## 5 YEAR PRODUCT WARRANTY Fiberglass Reinforced Polymer Composite Products

**SureWerx warrants to the Project Owner that the AccessTile Tactile Walking Surface Indicator products supplied by SureWerx are free from defects in material including deformation, breakage, and delamination for a period of Five (05) years from the date of substantial completion of the project.**

*EXCLUSIVE REMEDIES: SureWerx, at its cost, will repair or replace defective material promptly reported to SureWerx during the warranty period. This warranty includes labor costs and cost of removal of the product. Repair or replacement will be done on site.*

*WARRANTY LIMITATIONS: The warranty of AccessTile products does not apply to conditions resulting from improper installation, improper use, external causes, intentional misuse, or abuse, neglected or improper annual maintenance, vandalism, modifications to the AccessTile products or installation procedures with the exception of the Owner's right to immediately eliminate an unsafe condition.*

*DISCLAIMER OF WARRANTY: The above warranties are the Owner's exclusive warranties. No other warranty, express or implied, shall apply. SureWerx specifically makes no warranty of merchantability and/or fitness for a particular purpose. In no event shall SureWerx be liable for any damages, lost profits, direct, consequential, or economic damages.*

Issued Date: 00/00/2024  
Effective Date: 00/00/2024

Project: Name/Identifier

Issued to: Contractor Name  
Address  
City, ST 00000

Owner: Owner Name  
Address  
City, ST 00000

Manufacturer: **SureWerx (AccessTile, a SureWerx Brand)**  
Product: Detectable Warning Panels, Brick Red Fiberglass  
Description: reinforced polymer composite material

Issued by:

John Stieby  
Name

Director of End User Sales  
Title

00/00/2024  
Date





325 Corporate Drive  
Elgin, IL 60123  
USA

**US Customer Service**  
Tel: 1-844-697-2920 | Fax: 1-833-652-1547  
Email: [orders.ci.usa@surewerx.com](mailto:orders.ci.usa@surewerx.com)

[www.surewerx.com](http://www.surewerx.com)