



SureWerx®

Be Smart. Be Safe. Be Sure.®



U.S. SAFETY CATALOG

PPE & WELDING



TABLE OF CONTENTS

WELDING

HELMETS & ACCESSORIES	<u>8-47</u>
HELMET / HARD HAT MOUNTING SYSTEMS	<u>48-49</u>
FILTERS & PLATES	<u>50-57</u>
CONNECTORS, CLAMPS, & ELECTRODES	<u>58-59</u>
PIPE & TOOL MARKING ACCESSORIES...	<u>60-63</u>
CURTAINS & BLANKETS	<u>64-75</u>

PPE

FACE PROTECTION	<u>79-111</u>
EYE PROTECTION – SAFETY GLASSES	<u>112-127</u>
EYE PROTECTION – GOGGLES	<u>128-143</u>
EMERGENCY EYEWASH PRODUCTS ...	<u>144-146</u>
HEARING PROTECTION	<u>147-155</u>
HEAD PROTECTION	<u>156-173</u>
RESPIRATORY PROTECTION	<u>174-175</u>
KNEE & ELBOW PROTECTION	<u>177-181</u>
SLIP PROTECTION / ICE & SNOW TRACTION	<u>182-196</u>

SAFETY APPAREL

HI-VIS SAFETY VESTS, SASHES, & GAITERS	<u>202-213</u>
HI-VIS SAFETY SHIRTS & HOODIES....	<u>214-216</u>
HI-VIS TRAFFIC SAFETY WEAR	<u>217</u>
HI-VIS SAFETY RAINWEAR & JACKETS	<u>218-225</u>
FLAME-RESISTANT SAFETY WEAR....	<u>226-227</u>
SAFETY APPAREL STANDARDS & SIZING	<u>228-234</u>

FALL PROTECTION

HARNESSES & BELTS	<u>241-259</u>
SELF-RETRACTING LIFELINES	<u>260-270</u>
LANYARDS	<u>271-274</u>
VERTICAL LIFELINES & ROPE GRABS ..	<u>275-277</u>
ANCHORAGE CONNECTORS	<u>278-282</u>
TANK TROLLEYS	<u>283</u>
KITS	<u>284-296</u>
HARDWARE & ACCESSORIES	<u>297</u>
LADDER SAFETY SYSTEM	<u>298-305</u>
EMERGENCY DESCENT SYSTEMS	<u>306-307</u>
ENGINEERED SYSTEMS	<u>308</u>
TOOL TETHERING SYSTEMS	<u>309-314</u>
STANDARDS & REGULATIONS	<u>315</u>



ABOUT SureWerx

BE SMART. BE SAFE. BE SURE.

At SureWerx, our mission is to produce the most innovative and rigorously tested products for our customers' safety, productivity, and comfort. Our head-to-toe product portfolio consists of over a dozen leading brands with a full offering of PPE, safety, and equipment solutions.

No one works harder to keep workers and communities productive and safe. That's the SureWerx promise.

www.surewerx.com/usa



"We want all of our distributor partners and the end users of our products to experience tangible value for the products and services we offer and we will continue to enhance that proposition vastly over the coming years "

– A message from our CEO, Chris Baby

Industries Served



MANUFACTURING/MRO



INDUSTRIAL



WELDING



**INFRASTRUCTURE
& CONSTRUCTION**



SAFETY

surewerx.com/usa

The Quality You Have Come to Expect

Products Made to Perform — All products are designed to maximize safety, productivity, and comfort to help workers perform at their best.

Certified To Be Safe — The SureWerx family of products are tested to meet or exceed the rigorous standards for quality and safety performance by ANSI, CSA, CE, and more, but we don't stop there. We further ensure the safety of our products by managing our own in-house, fully accredited test lab which carefully monitors all products prior to leaving our state-of-the-art distribution center.

Confidence In Our Quality — We offer some of the most comprehensive warranties in the industry. Wherever the job takes you,



Digital Solutions

OUR NEW WEBSITES ARE LIVE



Visit us at
surewerx.com/usa
jacksonsafety.com
sellstrom.com
duenorthproducts.com
fallprotection.com

NEW PRODUCT ANNOUNCEMENT



TECHNICAL DATA SHEETS

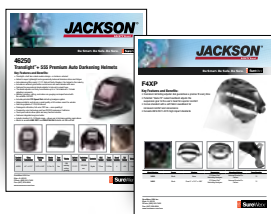

DOWNLOADS



VIDEO LIBRARY



**ENERGY/
OIL & GAS**

surewerx.com/usa



FOOD PRODUCTION



**TRANSPORTATION
& AUTOMOTIVE
AFTERMARKET**



HEALTH CARE



RETAIL

Table of Contents

YOUR BEST WORK YET... NEEDS YOUR TOTAL FOCUS

The safety and productivity of every professional worker is our goal. Our mission is to design products that deliver on this goal. We are always finding better ways to help increase worker productivity and safety.



Every day, hundreds of professional workers are injured at work — industrial accidents are avoidable.



Our goal is to ensure that you return home after a safe and productive day at work in the same healthy condition as you went to work.



Legislation and regulation continue to increase safety at work, and all of our products will meet or exceed the necessary levels.



We will also work to ensure that all of our distributors receive product knowledge training to ensure they provide the right product for the right application. We are committed to understanding the needs of the professional end users.



When workers are confident that their PPE is designed with their health and safety in mind, they can concentrate on the job at hand, achieving maximum productivity.

● ACCIDENTS

● INJURIES

● RISK

Reduce ● ● ● ●



Increase

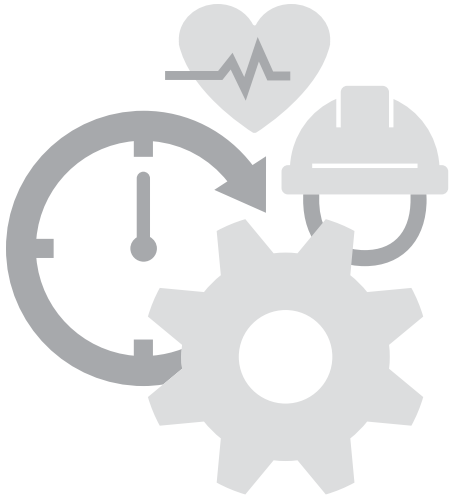

HEALTH SAFETY PRODUCTIVITY

Be Smart. Be Safe. Be Sure.



JACKSON
SAFETY

EXCLUSIVE!



370
SPEED DIAL™

The World's Greatest Ratcheting Headgear System — Period!

Our patented Jackson Safety® 370 Speed Dial™ offers the fastest, easiest, and most efficient ratcheting headgear system in the industry today! The 370 Speed Dial™ incorporates two unique designs – an oversized ratcheting adjuster knob, and a patented “quick-fit” rear headband that swivels up and down. Together, these two features combine to achieve a perfect fit every time, increasing safety, productivity and satisfaction. Try any of our industry-leading Jackson Safety® products that incorporate our famous 370 Speed Dial™ and experience the difference yourself!



The 370 Speed Dial™ ratcheting headgear can be found on these exclusive Jackson Safety® industry-leading products. More new products coming soon!

<p>Jackson Face Shields</p>	<p>NEW!</p>  <p>Quad 500</p>	<p>NEW!</p>  <p>Maxview</p>	<p>NEW!</p>  <p>F4XP</p>		
<p>ADF Welding Helmets</p>	<p>NEW!</p>  <p>Translight+ 555</p>	<p>NEW!</p>  <p>Translight 455 Flip</p>	 <p>Truesight II Series</p>	 <p>Insight® Series</p>	 <p>NexGen® Series</p>
<p>Passive Welding Helmets</p>	 <p>HSL-1</p>	 <p>HSL-2</p>	 <p>HSL-100</p>	 <p>HLX-100</p>	
<p>Hard Hats</p>	 <p>SC-6 Series</p>	 <p>Blockhead® Series</p>	<p>NEW!</p>  <p>Blockhead® FG Series</p>		

Jackson Safety® – Your First Choice for Premium Safety Products for Over 90 Years!

Please note: Our SC-6 and Blockhead hard hats use a modified version of the face shield/welding helmet version shown. All products feature the exclusive 370 Speed Dial™ for “Easy Grip-Easy Turn” adjustment.



JACKSON[®]
SAFETY

sellstrom[®]

**WELDING HELMETS,
FILTERS, AND PLATES**

**SPARKS
PRODUCTIVITY**

WELDING PROTECTION PPE



WELDING HELMETS AND WELDING FILTERS

Designed to perform in a wide range of welding applications, Jackson Safety®, Huntsman®, and Sellstrom® welding helmets are available in a variety of styles, shapes and base materials including our latest Translight 455 Flip, Translight+ Extra-Large View ADF helmets, and the new Rebel welding mask.

Choose from a selection of filters – from *passive* to *digital ADF* platforms and numerous graphic designs to reflect personal style.

PASSIVE VS. AUTO-DARKENING FILTER HELMETS

Passive helmets offer great protection.

Auto-Darkening Filters offer protection and productivity.

Both passive and Auto-Darkening Filter (ADF) welding helmets provide excellent eye protection. Research shows that ADF helmets also offer impressive productivity gains, as well as greater user comfort.

ADDED BENEFITS OF AN ADF

● Increased accuracy

Because the welder can always see what he's doing, and start in exactly the right spot.

● Increased comfort

By eliminating the repetitive "lifting and nodding" that can cause neck strain.

● Increased protection

From injuries caused by welding, chipping, or grinding in the proximate area.

● Increased peace of mind

Because even if the ADF should not become active during an arc, it still protects eyes from serious damage.

● Increased productivity

By eliminating the time it takes to lift and nod the helmet before and after each weld.

Welders at all experience levels know the value and essential protection requirements of the right helmet and filter for the right job. That's why we provide a range of welding helmets and filters with features that are just right for you.

True Color ADF

Jackson Safety and Sellstrom auto-darkening filters with premium 1/1/1/1 optical classification and True Color technology provide:

● A clear view from various angles

Which can reduce eye fatigue (the need to move, adjust and refocus).

● Superior optical quality

Allows you to do your most creative and productive work.

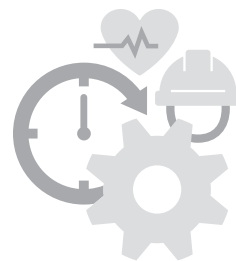

HEALTH
SAFETY
PRODUCTIVITY

Be Smart. Be Safe. Be Sure.

WELDING FILTERS

SAFETY FIRST

● Meets ANSI, CSA, and CE standards

ADFs are built and tested to meet or exceed ANSI, CSA, and CE standards

● Protection against UV and IR light

ADFs are designed so that regardless of dark or clear state welder's eyes are **always protected** against harmful UV and IR light occurring during welding process.

● Excellent switching speed

Switching speed and detection of welding arc **prevent light flash** from reaching welder's eyes.

● Safe in any weld process

Variable shade level, sensitivity and delay allow for **adjusting protection** parameters to any weld process.

WIDE SELECTION OF PRODUCT PERFORMANCE LEVELS AVAILABLE



EASE OF WORK

ADFs can be adjusted to any type of welding by selecting shade level, sensitivity to welding arc, and opening time delay.

Selectable operation mode (Weld/Grind/Cut) allows for permanent eye protection during the whole metal processing operation.

Increased productivity as both hands can be used.

● Simple welding tasks

Use passive or single shade ADFs.

●● Entry level welding tasks

Limited shade range, average speed, and window size – cost effective.

●●● Professional tasks

All required features at moderate cost with added functionality.

●●●● Extremely demanding tasks

Highest optical performance, switching speed, sensitivity range and various modes of operation.

555

3/5-8/9-14 SM 1/1/1/1/379 CE
ANSI Z87.1-15 CSA Z94.3-15 AS/NZS 1338.1

OPTICAL PERFORMANCE

Available highest level of **1/1/1/1** with highest optical clarity, homogeneity, and wide viewing angle.

Available **True Color** for better process control.

Large selection of available viewing area sizes from 35 to 80 cm².

- **1/1/1/1**
- **True Color**
- **S to XL viewing area**

DELAY



CUT



GRIND



WELD



Low battery

SENS



SHADE

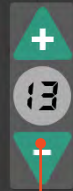

- **Shade level**
- **Sensitivity**
- **Operation mode**
- **Opening time delay**

ADDITIONAL FEATURES

● Highest speed ADFs

Surface mode technology on some models.

● ADF power source selection

- **Replaceable batteries** (alkaline or lithium).
- **Fixed batteries** – No battery changes for the lifetime of the product.
- **Solar cells** for battery life extension.

● Low weight and ultraslim ADFs

Reduced weight and ultra-slim ADFs available.

● Warranty

1, 2, 3, or 5 year warranty depending on ADF model.

JACKSON
SAFETY



TrueSight II Digital Variable Auto-Darkening Filter Welding Helmet with Balder Technology



THE BALDER DIFFERENCE

World Class Optics. Advanced Technology. Continuous Improvements in Productivity and Safety.

These are the key features that separate a Jackson Safety welding helmet from the competition, and our patented Balder Technology continues to set the standard for professional-grade welding helmet ADFs.

With Balder Technologies' crystal clear optics, Jackson Safety has become the world-class leader in auto darkening filters. Balder was first to market achieving the highest 1/1/1/1 standard for optical clarity. Over the years, Balder has helped develop several unique, proprietary technologies that you can only find under the Jackson Safety brand. Today, we offer the widest range of technologies and the most auto-darkening filters achieving top optical clarity on the market.

Surface Mode Technology

In the light state of a surface-mode liquid crystal display, only the liquid crystal molecules at the outside surfaces are at rest with their long axis parallel to the display's outer surfaces. The liquid crystal at the center of the display is aligned perpendicular to the outside display surfaces. When the high voltage pulse is applied, only the molecules near the surface need to rotate the full 90 degrees as the filter switches. Therefore, the switching speed is much faster.

- Surface Mode Series options: **NexGen**

Twisted Nematics Technology

Twisted nematics liquid crystal display molecules in the light state are parallel to the display's outer surfaces. When the high voltage pulse is applied, the molecules rotate a full 90 degrees.

This technology is commonly used in many of the welding helmets on the market today.

- Twisted ADF Series options: **Insight, 555, 455**

Super Twisted Nematics Technology

Similar technology to twisted nematics, only the molecules are now rotated a full 180 degrees. This greatly improves on optical clarity consistently, and far surpasses the highest optical clarity standards of 1/1/1/1.

- Super Twisted ADF Series options: **TrueSight II**

Why Balder & Jackson Safety?

- Most 1/1/1/1 top optical clarity ADFs
- Most types of in-use technology
- The best warranty program at 5 years
- Options available for every type of welder
- Over 85 years of product experience

What is Optical Class?

Optical class is becoming a global standard that originates as a European standard tested by third parties. Welding helmets' auto-darkening filters are rated from 1 (best) to 3 (worst) in the following optical classes: Optical Clarity, Diffusion of Light, Homogeneity, and Angular Dependence. 1/1/1/1 is the best rating an auto-darkening filter can achieve.

Optical Clarity

Measures how clear or distorted objects look through the filter



Diffusion of Light

Looks at impurities of the glass

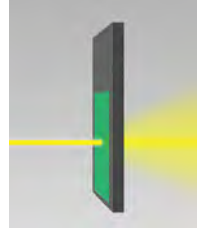

Homogeneity

Examines the consistency of the shade at different parts of the glass

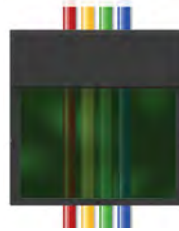

Angular Dependence

Looks at shade consistency at different angles

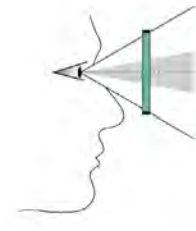

NEW!

NEW!

UPGRADED!

ADF SERIES	TRUESIGHT II	555	455	INSIGHT	S26400	S26200	NEXGEN	S26100	WH30
Quality	*** BEST	*** BEST	*** BEST	*** BEST ↔ ** BETTER	** BETTER	** BETTER	** BETTER	* GOOD	* GOOD
Compatible Shells	HLX	Translight+	Translight Flip	HLX, HSL	WHP	WHM	HLX, HSL	WHB	Advantage
Available Designs	Black, graphics	Black	Black, black with hard hat	Black, graphics	Black	Black	Black, graphics	Black	Silver
Shade Range	4, 5-13	3, 5-14	4, 5-13	4, 9-13	4, 5-13	4, 9-13	4, 9-13	4, 9-13	4, 9-13
Switching Speed	1/8,700 sec	1/25,000 sec	1/40,000 sec	1/10,000 sec	1/20,000 sec	1/15,000 sec	1/15,000 sec	1/10,000 sec	1/2,100 sec
Cartridge Size	4.5" x 5.25"	4.5" x 5.25"	90 x 100mm	4.5" x 5.25"	4.5" x 5.25"	4.5" x 5.25"	4.5" x 5.25"	3.54" x 4.33"	3.5" x 4.33"
Viewing Area	3.25" x 4"	3.23" x 3.86"	2.5" x 3.86"	2.35" x 3.8"	3.28" x 3.94"	2.36" x 3.94"	2.35" x 3.8"	1.57" x 3.54"	1.65" x 3.78"
Viewing Area sq. in.	13 sq. in.	12.47 sq. in.	9.65 sq. in.	8.93 sq. in.	12.92 sq. in.	9.30 sq. in.	8.93 sq. in.	5.56 sq. in.	6.24 sq. in.
Optical Clarity	1/1/1/1	1/1/1/1	1/1/1/1	1/1/1/1	1/1/1/1	1/1/1/2	1/2/1/2	1/1/1/2	1/1/1/2
True Color	•	•	•	•	•	•	•	•	•
Welding	•	•	•	•	•	•	•	•	•
Grinding	•	•	•	•	•	•	•	•	•
Cutting	•	•	•	•	•	•	•	•	•
TIG < 5 amps or Pulse TIG	•	•	•	•	•	•	•	•	•
Torch & Grind	•	•	•	•	•	•	•	•	•
Submerged Arc	•	•	•	•	•	•	•	•	•
Plasma Arc, Stud Arc, Electroslag, Flux Cored ARC, STICK, MIG	•	•	•	•	•	•	•	•	•
370 Speed Dial Headgear	370 SPEED DIAL	370 SPEED DIAL	370 SPEED DIAL	370 SPEED DIAL	No	No	370 SPEED DIAL	No	No
Special Features	True Color tech, large viewing area	External fine shade tuner and grind button	Industry-leading extra large grinding face shield	Professional grade at market-friendly price, newly improved optical clarity	Saves up to three preset welding configurations		Unique surface mode technology	Value priced	
Warranty	5 years	3 years	3 years	2 years	2 years	2 years	2 years	2 years	2 years

sellstrom®

SELECTING THE BEST SHADE FOR THE JOB

According to OSHA, the intensity of visible light and radiant energy produced by operations varies depending on the task, the electrode size, and the arc current. Workers involved in welding, cutting, and brazing operations must use appropriate welding protection depending on specific welding operations.

Only filter lenses with the appropriate shade number will provide protection against optical radiation. Filter lenses must coincide to specific radiant energy exposure. Welding protectors are constructed of heat resistant material such as vulcanized fiber or fiberglass and fitted with a filtered lens to protect workers' eyes from burns caused by infrared or other intense radiant energy. These devices protect the eyes and face from flying sparks, metal spatter, and slag chips produced during welding, brazing, soldering, and cutting.

Welding helmets are secondary protectors intended to shield the eyes and face from optical radiation, heat, and impact. Use welding helmets in addition to primary protection such as safety spectacles or goggles to provide adequate protection.



JACKSON®

SAFETY



HEALTH
SAFETY
PRODUCTIVITY

Be Smart. Be Safe. Be Sure.

ANSI Z49.1 Welding Shade Selector Chart

WELDING PROCESS	A (Ampère)	0.5	1	2.5	5	10	15	20	30	40	50	60	70	80	90	100	125	150	160	175	200	225	250	275	300	350	400	450	500	550+	
Stick (SMAW)															10						12					14					
MIG (GMAW)															11						12					14					
TIG (GTAW)								10						12										14							
Plasma Welding				6-8							10										12								14		
Plasma Cutting				4				5	6	8								9							12			14			

Shade numbers are given as a guide only and may be varied to suit individual needs. As a rule of thumb, start with a shade that is too dark then go to a lighter shade without going below the minimum.

WELDING HELMET SHELLS – ADF OPTIONS

ADF	JACKSON SAFETY					SELLSTROM	
	SERIES	TRANSLIGHT+	TRANSLIGHT FLIP	REBEL	HLX (HALO X)	HSL (SHADOW)	WHP
							
Key Features	Modern design to reduce spark and spatter landing points, large viewing window, engineered to reduce neck strain	Flip-style welding helmet with large 46" face shield viewing area and top grade welding ADF	An exclusive compact welding mask featuring modern digital ADF controls. Ideal for use under hard hats and comes with FR hood	Made with patented hydroflex plastic, ultra lightweight at 6 oz.	Classic HSL Shadow style helmet, narrow and designed with additional neck protection from sparks and spatter	Ultra-lightweight, modern design for optimal comfort	External controls to adjust shade or grind mode without removing helmet
Cartridge Size	4.5" x 5.25"	90 x 110mm	2" x 4.25"	4.5" x 5.25"	4.5" x 5.25"	4.5" x 5.25"	3.54" x 4.33"
Grinding Face Shield	No	Yes	No	No	No	No	No
370 Speed Dial Headgear			No			No	No

WELDING HELMET SHELLS – PASSIVE OPTIONS

PASSIVE	JACKSON SAFETY					SELLSTROM		
	SERIES	HUNTSMAN 900 SERIES	HUNTSMAN 400 SERIES	HUNTSMAN LEATHER	HSL-2 (SHADOW)	HSL-1 (SHADOW)	290 SERIES	280 SERIES
								
Key Features	Lightweight and highly washable	Made with vulcanized fiber to withstand higher heat applications	Flexible for confined space use, full head coverage	Lift front-style helmet to easily switch from welding to grinding function	Classic passive helmet with extended neck protection from sparks and spatter	Contains extended bib for added spark and spatter protection	Round configuration helps reduce sparks and spatter from sticking to helmet	Designed for confined space, with leather bib for additional spark protection
Compatible Options	4.5" x 5.25" 2" x 4.25" lift front	4.5" x 5.25" 2" x 4.25" lift front 2" x 4.25" fixed front 2" x 4.25" quick slide	Lift front Lift front (no headgear)	2" x 4.25" lift front	2" x 4.25" fixed front	2" x 4.25" lift front 2" x 4.25" fixed front 4.5" x 5.25" fixed front	2" x 4.25" lift front 2" x 4.25" fixed front 4.5" x 5.25" fixed front	2" x 4.25" lift front
370 Speed Dial Headgear	No	No	No			No	No	No

NEW ULTRA-LIGHTWEIGHT WELDING HELMET OPTIONS



46250



46240



46200

JACKSON[®]
SAFETY

A JACKSON EXCLUSIVE!

JACKSON SAFETY

WELDING MASK - ADF



ADF WELDING MASK – REBEL™

BEST

BETTER

JACKSON
SAFETY

Rebel™ ADF Welding/Goggle Mask – Digital

NEW!

The all new, exclusive Jackson Safety® Rebel™ welding mask is a great addition to our welding program, incorporating modern ADF technology. The Rebel™ is a lightweight product designed to reduce neck strain. In addition, the Rebel is designed to fit under most hard hats, including Jackson's Charger, Sentry III, SC-6, Advantage Series, and Blockhead models without the need for adaptor brackets, making it extremely versatile.

- The Rebel features an exclusive, modern digital ADF control system
- Goggles are constructed with the face shield as one complete unit
- Complete protection from sparks and spatter risks to front of face when used with the fire-resistant hood
- The Rebel's close-fitting goggle protects against UV and IR rays when used with the fire-resistant hood
- Designed to fit over most prescription glasses — no cheater lenses required
- Features a replaceable clear outer lens for added ADF protection (46930 — 5 pack)
- Packaged in attractive, full-color POP box — case quantity 6
- No adapters needed to use with hard hats
- Low TIG amp rated >10A
- Battery life lasts up to 1,300 hours (batteries replaceable)
- Meets or exceeds **ANSI Z87.1** and **CAN/CSA Z94.3** standards. **CE certified**



46200



PRODUCT NO.	Filter Dimensions	Viewing Area	Shade Range	True Color	Modes	Optical Clarity	Switching Speed	Controls	Weight	No. of Sensors	TIG Rating	Warranty
46200	2" x 4.25"	1.38" x 3.54"	3, 5 to 12	Yes	Welding	1/1/1/2	1/15,000 sec.	Digital	8.8 oz.	2	>10A	2 years

True Color technology

Compatible with prescription glasses

One-piece design protects against UV and IR leakage, as well as spark and spatter penetration

Convenient push-button digital controls

Exclusive wrap-around face shield for added protection



ADF WELDING MASK – REBEL™

BEST

**
BETTER

NEW!

PRODUCT NO.	Description	Case Qty.
46200	Rebel ADF Digital Welding/Goggle Mask (Kit)	6
46600	Replacement Fire-Resistant Hood	10
46930	Rebel™ Replacement Lens Kit (Pack contains 5 External and 3 Internal Lenses)	100

Contains a fire-resistant hood for head protection

Comfortably fits under hard hats

Light and easy to remove



EXCLUSIVE!

JACKSON
SAFETY



46600

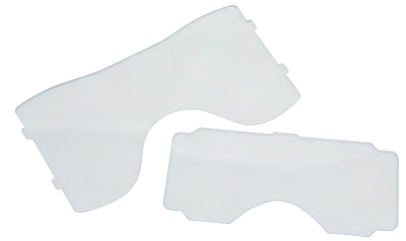

46930

JACKSON SAFETY

WELDING MASK – ADF



JACKSON[®]
SAFETY

A JACKSON EXCLUSIVE!

JACKSON SAFETY

WELDING HELMETS -ADF





TRANSLIGHT™ + 555

PREMIUM LARGE-VIEW ADF WELDING HELMET

BEST

The new Jackson Safety **Translight™ Series** contains our latest innovative welding helmet designs. We mix industry leading features with new advancements in technology to transcend the welding industry.



All Translight™ helmets come with our patented **370 Speed Dial™** ratcheting headgear system, to create the ultimate balance in comfort and functionality. The latest advancements in True Color technologies are included for optimum welding optics. Our Translight™ product line is packed with new features and improvements to keep workers safe and highly productive.



555 Digital ADF

NEW!

46452

JACKSON[®]
SAFETY

JACKSON SAFETY

WELDING HELMETS -ADF



ADF WELDING HELMETS – TRANSLIGHT™+ SERIES

BEST

JACKSON
SAFETY

Translight™+ 555 Premium Auto Darkening Helmets

NEW!

- Translight™ shell has a sleek modern design — a Jackson exclusive!
- Helmet is super lightweight and ergonomically balanced to reduce stress and fatigue
- Auto darkening filter meets 1/1/1/1 Optical Clarity Standard, the highest in the industry
- Includes an external grind button so end users can switch modes with ease
- Features the new external shade adjuster to help aid in visual focus
- The shade adjuster can finely tune shades up to ±1 full shade with .2 shade adjusting increments
- Welding, grinding, cutting, and carbon arc gouging can be performed with the versatile 555 ADF
- Includes patented **370 Speed Dial** ratcheting headgear system
- Advanced digital controls are a great quality-of-life enhancement for welders
- Switching speeds of 1/25,000 second
- Packaged in attractive, full-color POP box — case quantity 4
- Powered by solar technology and two CR2032 replacement batteries
- Touch pad controls allow quick and easy function selection
- Features integrated mag lens holder
- Industry leading 3/5–14 Shade range — allows use in high amp welding applications
- Meets or exceeds **ANSI Z87.1** and **CAN/CSA Z94.3** standards. **CE certified**



46250

PRODUCT NO.	Filter Dimensions	Viewing Area	Shade Range	True Color	Modes	Optical Clarity	Switching Speed	Controls	ADF Weight	Total Weight	No. of Sensors	TIG Rating	Warranty
46250	4.5" x 5.25"	3.23" x 3.86"	3, 5 to 14	Yes	CAG, welding, cutting, grinding	1/1/1/1	1/25,000 sec.	Digital	7.6 oz.	1.35 lbs.	4	>3A	3 years

EXCLUSIVE!



PRODUCT NO.	Description	Case Qty.	PRODUCT NO.	Description	Case Qty.
46250	Translight+ 555 ADF Helmet Complete	4	46925	555 External Safety Plate (Pack of 10)	100
46452	Translight+ 555 Replacement ADF only	10	46995	555 Replacement Retainer	10
46550	Translight+ Replacement Shell – Black	20	20693	Translight 555+ Replacement 370 Headgear	6
46915	555 Internal Safety Plate (Pack of 10)	100	32187	Replacement Washable Sweatband – 2/pack	24 packs

Super lightweight and ergonomically balanced to reduce stress and fatigue

True Color ADF
1/1/1/1 rating;
4.5" x 5.25" filter size

Switching speeds
of 1/25,000 sec

Four-sensor
technology

Specially designed neck
bib provides superior
protection from spatter



46250

12.47 sq.
in.
viewing area!

Designed for use
with respirators

370
SPEED DIAL

Features Jackson Safety® premium 370 series Easy Grip-Easy Turn ratcheting mechanism – an industry best!

Convenient
external grind
mode button

External shade adjuster –
finely tune shades up to ±1 full
shade in .2 shade increments





TRANSLIGHT™ 455 FLIP – PREMIUM FLIP ADF WELDING HELMET

BEST

Featuring the exclusive Jackson Safety® 370 Speed Dial™ ratcheting headgear system!

The Translight™ 455 Flip helmet delivers world-class grinding and welding with the flip of the lid. This super-lightweight helmet offers the ability to perform pre/post preparation work and welding operations in one versatile product. The combination of a robust welding helmet and oversized grinding visor (46 sq. in.) makes this unique system suitable for all metal fabrication applications.

We have also fitted the Translight™ 455 Flip with the highest rated 1/1/1/1 optical clarity filter for improved welding efficiency while reducing operator fatigue. Professional grade components for professional grade welders.



>2 Amp

455 Digital/Analog ADF

NEW!

370
SPEED DIAL™

True
Color

Super lightweight
ADF and shell
technology ensures
minimal operator
strain and fatigue



Best-in-class
optical clarity
1/1/1/1

World-class
1/40,000 sec.
switching
speed

Combination
of digital
and analog
controls

46442

JACKSON[®]
SAFETY

JACKSON SAFETY

WELDING HELMETS -ADF



ADF WELDING HELMETS – TRANSLIGHT™ FLIP SERIES

BEST

JACKSON
SAFETY

Translight™ 455 Flip Premium Auto Darkening Helmets

NEW!

- Translight™ 455 Flip welding helmet comes with an easy-to-use lift mechanism to raise up the welding ADF assembly, which exposes a clear face shield window for grinding and chipping operations, offering exceptional peripheral vision
- The Jackson Translight™ 455 Flip welding helmet features a modern, carefully designed sleek, ergonomic super-lightweight shell and ADF, ensuring maximum protection while providing optimal comfort and reduced operator stress and fatigue
- Auto darkening filter meets 1/1/1/1 Optical Clarity Standard, the highest in the industry
- The shell contains left-to-right tabs that allow easy raising and lowering of the flip module
- Welding, grinding, cutting, and carbon arc gouging can be performed with the versatile 455 welding helmet
- Includes patented **370 Speed Dial** ratcheting headgear system
- Switching speeds of 1/40,000 sec. are the quickest in the industry
- Low TIG amp rated >2 amps
- Powered by solar technology and two CR2032 replacement batteries
- Packaged in attractive, full-color POP box — case quantity 4
- Features integrated mag lens holder
- Meets or exceeds **ANSI Z87.1** and **CAN/CSA Z94.3** standards. **CE certified**



46240

PRODUCT NO.	Filter Dimensions	Viewing Area	Shade Range	True Color	Modes	Optical Clarity	Switching Speed	Controls	ADF Weight	Total Weight	No. of Sensors	TIG Rating	Warranty
46240	90 x 110mm	2.5" x 3.86"	4, 5 to 13	Yes	CAG, welding, cutting, grinding	1/1/1/1	1/40,000 sec.	Digital/Analog	4.1 oz.	1.6 lbs.	4	>2A	3 years

EXCLUSIVE!



PRODUCT NO.	Description	Case Qty.	PRODUCT NO.	Description	Case Qty.
46240	Translight 455 Flip Welding Helmet with ADF – Black	4	46914	Translight 455 Internal Safety Plate (Pack of 10)	100
46442	Translight 455 Flip Replacement ADF	10	46923	455 External Safety Plate (Pack of 10)	100
46540	Translight 455 Flip Replacement Shell – Black	20	46991	455 Flip Spring Mechanism Kit	10
46640	455 Flip Clear Face Shield Replacement Windows (Pack of 5)	10	20693	Translight 455 Flip Replacement 370 Headgear	6
			32187	Replacement Washable Sweatband – 2/pack	24 packs

Super lightweight ADF and shell technology ensures minimal operator strain and fatigue

ADF controls are easily accessible when in the up position

Extra-large face shield – 46 sq. inch

Superior peripheral vision

Specially designed neck bib provides superior protection from spatter



True Color ADF 1/1/1/1 rating

Convenient left and right tabs allow easy raising and lowering of the flip module

The ADF flip module has been specially designed to allow a completely unobstructed view when in the up position

9.65 sq. in. viewing area!

370
SPEED DIAL

Features Jackson Safety® premium 370 series Easy Grip-Easy Turn ratcheting mechanism – an industry best!

46240



Halo X shell



46118

Jackson TrueSight II ADF
European designed and manufactured

Industry best 5-year warranty True Color



Highest rated optical clarity 1/1/1/1

46158

Digital controls

ADF WELDING HELMETS – TRUESIGHT® II SERIES

BEST

TrueSight® II ADF Welding Helmet with Balder® Technology

The **TrueSight II** is one of Balder's most recent creations, enhancing their standards as one of the best ADFs globally. This auto-darkening filter contains another achievement with highest rated 1/1/1/1 optical clarity. Enhanced features include grinding and torch modes, as well as increased shade ranges for the serious professional welder.



Balder Technology makes it easier to perform a variety of welding related processes at your best. The Balder sensors can pick up as little as .5 amps, and provide a superior experience for the serious TIG welder. Couple this with an industry-best 5-year warranty. You can rest comfortably at night knowing you are providing your eyes, neck, and head with a leading helmet to help you work safe.

- Comes with patented Balder technology for superior optics
- Features highest rated optical class 1/1/1/1
- Intuitive digital controls
- Weld/Torch/Grind mode compatible
- Uses two AAA batteries, replaceable
- Low battery indicator
- Built-in magnification lens holder
- Comes with patented **370 Speed Dial** headgear
- Available in a variety of graphics
- Meets **ANSI Z87.1, CSA Z94.3 compliant, DIN+ certified**



13 sq.
in.
viewing
area!

ADF compatible with HLX and HSL helmets



46159
Black



46163
Arc Angel

SERIES NAME	Filter Dimensions	Viewing Area	Shade Range	True Color	Modes	Optical Clarity	Switching Speed	Controls	Weight	No. of Sensors	Warranty
TrueSight II	4.5" x 5.25"	3.25" x 4"	4, 5 to 13	Yes	Welding, grind, torch	1/1/1/1	1/8,700 sec.	Digital	24 oz.	4	5 years



Hard Hat Interchange System

Look for this symbol for helmets compatible with the Hard Hat Interchange System

PRODUCT NO.	Description	Case Qty.
46159	HLX Welding Helmet with TrueSight II ADF – Black	1
46118	HLX Welding Helmet with TrueSight II ADF – Stars & Scars	1
46163	HLX Welding Helmet with TrueSight II ADF – Arc Angel	1
46158	TrueSight II ADF Cartridge – 4.5" x 5.25"	1
30320	TrueSight II External Safety Lens, 10 pack	10
30321	TrueSight II Internal Safety Lens, 10 pack	10
38426	Hard Hat Interchange System (HHIS)	1
20696	370 Speed Dial Headgear System	1
32187	Replacement Washable Sweatband – 2/pack	24 packs



30320



30321

A JACKSON EXCLUSIVE!

JACKSON[®]
SAFETY

JACKSON SAFETY

WELDING HELMETS -ADF





Two legendary helmet styles



HSL Shadow

46129



HLX Halo X

46131

ADF WELDING HELMETS – INSIGHT® SERIES



Insight® ADF Welding Helmet

Jackson Safety's **Insight ADF** provides professional-grade quality at an affordable price. The Insight Series is offered in both HLX (Halo X) and HSL (Shadow) helmet configurations, but also can be easily fitted into both of the Sellstrom WHP and WHB series shells.

Our Insight series remains our most popular selling ADF welding helmet, but in an ongoing effort for product improvements, and through end-user customer feedback, we have now **upgraded the Insight ADF to include a 1/1/1/1 optical rating and True Color technology!** This improvement offers far superior welding clarity and ensures significant reductions in eyestrain.

Whether you are a professional welder or a weekend warrior, our Insight ADF welding helmet provides incredible performance at an affordable price.

- Newly updated to highest optical class 1/1/1/1
- Newly updated with True Color
- Digital controls
- Weld and grind modes
- Variety of graphic helmet options
- ADF compatible with HSL, HLX, WHP, and WHM shells
- Meets **ANSI Z87.1, CSA Z94.3 compliant**



9.3 sq. in. viewing area!



46128

SERIES NAME	Filter Dimensions	Viewing Area	Shade Range	True Color	Modes	Optical Clarity	Switching Speed	Controls	Weight	No. of Sensors	Warranty
Insight	4.5" x 5.25"	2.36" x 3.94"	4, 9 to 13	Yes	Welding, grind, torch	1/1/1/1	1/10,000 sec.	Digital	24 oz.	4	2 years

PRODUCT NO.	Description	Case Qty.	PRODUCT NO.	Description	Case Qty.
46129	HSL Welding Helmet with Insight ADF – Black	1	41589	Insight Safety Lens Kit – 5 external, 2 internal	10
46131	HLX Welding Helmet with Insight ADF – Black	1	41594	Insight Internal Safety Plate – 10 pack	10
46101	HLX Welding Helmet with Insight ADF – Stars & Scars	1	38426	Hard Hat Interchange System (HHIS)	1
46130	HLX Welding Helmet with Insight ADF – Arc Angel	1	20696	370 Speed Dial Headgear System	1
46138	HLX Welding Helmet with Insight ADF – I ²	1	32187	Replacement Washable Sweatband – 2/pack	24 packs
46128	Insight ADF Cartridge	1			



46101 – Stars & Scars



46130 – Arc Angel



46138 – I²



Features Jackson Safety premium 370 Series Easy Grip-Easy Turn ratcheting mechanism – an industry best!



Hard Hat Interchange System

Look for this symbol for helmets compatible with the Hard Hat Interchange System

OUR MOST POPULAR ADF HELMET SERIES!

ADF WELDING HELMETS – NEXGEN® SERIES



NexGen® ADF Welding Helmet

Jackson Safety's **NexGen ADF** is a tried and true technology that welders have continued to demand. One of Balder's first creations, the NexGen uses a "surface mode" technology that allows for only the surface molecules to rotate when switching from light to dark states. As a result, the helmet has a very smooth transition that is less noticeable and easy on a welder's eyes.

- Uses patented "surface mode" technology
- Digital controls
- Weld and grind modes
- Variety of graphic helmet options
- ADF compatible with HSL, HLX, WHP, and WHM shells
- Meets **ANSI Z87.1, CSA Z94.3 compliant**



8.9 sq. in. viewing area!

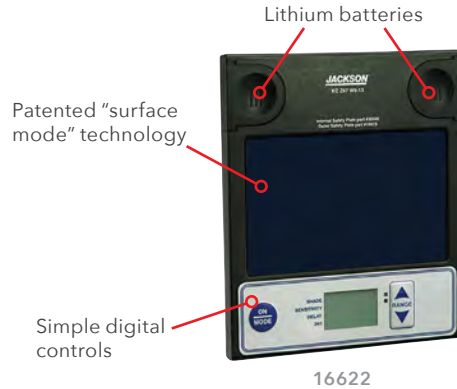

Two legendary helmet styles



HSL Shadow

46148



HLX Halo X

46151

SERIES NAME	Filter Dimensions	Viewing Area	Shade Range	True Color	Modes	Optical Clarity	Switching Speed	Controls	Weight	No. of Sensors	Warranty
NexGen	4.5" x 5.25"	2.35" x 3.8"	4, 9 to 13	No	Welding, grind, torch	N/A	1/15,000 sec.	Digital	25 oz.	4	2 years

PRODUCT NO.	Description	Case Qty.	PRODUCT NO.	Description	Case Qty.
46148	HSL Welding Helmet with NexGen ADF – Black	1	15984	Replacement Batteries CR2450, pair	10
46149	HLX Welding Helmet with NexGen ADF – I ²	1	15978	Replacement Battery Door, 10 pack	10
46151	HLX Welding Helmet with NexGen ADF – Heavy Metal	1	22606	NexGen Lens Kit – 5-pack external, 2-pack internal plates	1
46152	HLX Welding Helmet with NexGen ADF – Arc Angel	1	20696	370 Speed Dial Headgear System	1
16622	NexGen ADF Cartridge	1	30590	NexGen Internal Lens Kit	10
15977	Replacement Retainer – 10 pack	10	32187	Replacement Washable Sweatband – 2/pack	24 packs

370™ SPEED DIAL Features Jackson Safety premium 370 Series Easy Grip-Easy Turn ratcheting mechanism – an industry best!



Hard Hat Interchange System

Look for this symbol for helmets compatible with the Hard Hat Interchange System

WH40 Advantage Series Variable ADF Welding Helmet

- Features an economical lens for the consumer welder
- Solar-powered
- Features variable shade 9–13, sensitivity and delay adjustments
- Two independent sensors
- Meets **ANSI Z87.1** standards and **CSA compliant**
- Not for use with TIG welding



PRODUCT NO.	Old Code	Description	Units/Case
23282	3023293	WH40 Welding Helmet – Variable ADF – 90 x 110 mm	4
29127	3023295	WH40 Lens Kit – 5 Front and 2 Rear Safety Plates	10
23442	3023376	WH40 Replacement Headgear	6



23282



29127



ADF WELDING HELMETS – PREMIUM SERIES



Blue lens technology enhances the true color view

FULLY DIGITAL

Widest viewing area, ideal for difficult work angles – 3.28" x 3.94"

Designed for use with respirators



Three headgear position adjustments for better fit

12.92 sq. in. viewing area!

S26400

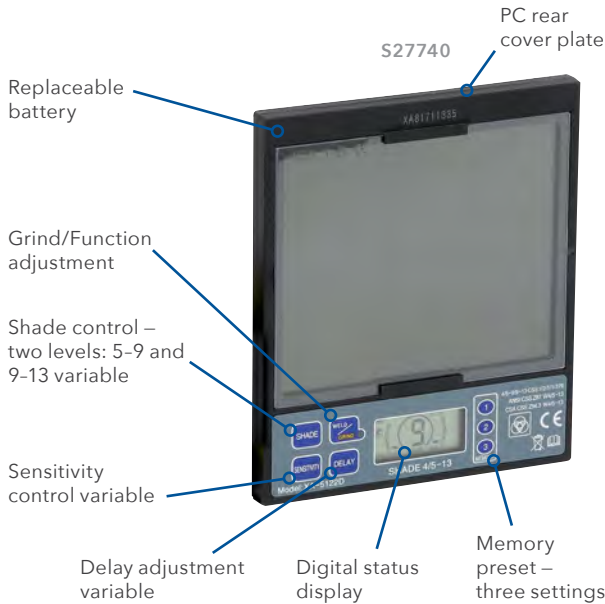

PREMIUM AUTO DARKENING HELMET

S26400 Premium Series Auto Darkening Helmet

- Blue lens technology allows more colors of the visible light spectrum to come through the lens for natural and more accurate tones
- Includes four arc sensors for amazing clarity, enhanced definition, and reduced eye fatigue
- Welding helmet can be used for TIG (>5A), MIG, and stick application
- Wider viewing area is ideal for difficult work angles
- Full digital operation — shade, sensitivity, delay, and weld/grind control
- Memory function allows the operator to store settings for future use (three selections)
- Solar and battery operated and includes low battery warning
- Internal controls for maximum protection
- Lightweight design is perfect for extended use
- Ideal for the professional welder and excellent for use in steel fabrication, steel erection, ship building, refinery construction, and much more
- Design allows for use of magnifier plate
- Meets and exceeds **ANSI Z87.1** and **CAN/CSA-Z94.3** standards
- **CE certified**

SERIES NAME	Filter Dimensions	Viewing Area	Shade Range	Power Control	Shade Control	Switching Speed	Sensitivity	Delay	Dark to Light	No. of Sensors
S26400	4.5 x 5.25"	3.28" x 3.94"	4, 5 to 13	Automatic	Internal	.08ms	Adjustable	Adjustable	0.1s-0.9s	4

PRODUCT NO. Description

S27740	Replacement ADF filter
S27006	Replacement Headgear
S19454	Replacement Cover Plates



9.3 sq. in. viewing area!

S26200

S26200 Advantage Plus Series Auto Darkening Helmet

- Outstanding protection, performance, comfort, and reliability
- Lightweight design is ideal for extended use
- Easy auto darkening filter and cover plate installation
- Welding helmet can be used for TIG (>5A), MIG, and stick application
- Internal controls for maximum protection
- Comfortable push and twist ratcheting headgear adjustment
- Comes complete with grind mode/grinding warning
- Designed for serious hobbyists, full-time welders, fabricators, and general automotive applications
- Design allows for use of magnifier plate
- Meets and exceeds ANSI Z87.1 and CAN/CSA-Z94.3 standards
- CE certified



S27720

SERIES NAME	Filter Dimensions	Viewing Area	Shade Range	Power Control	Shade Control	Switching Speed	Sensitivity	Delay	Dark to Light	No. of Sensors
S26200	4.5 x 5.25"	2.36" x 3.94"	4, 9 to 13	Automatic	Internal	.08ms	Adjustable	Adjustable	0.1s-0.9s	4

PRODUCT NO.	Description
S27720	Replacement ADF filter
S27006	Replacement Headgear
S19452	Replacement Cover Plates



5.56 sq. in. viewing area!

S26100



S27710

S26100 Advantage Series Auto Darkening Helmet

- Adjustable sensitivity and delay controls
- Lightweight design is perfect for extended use
- Welding helmet can be used for TIG (>5A), MIG, and stick application
- Offers excellent head and neck protection
- Comes complete with grind mode
- Designed for part-time users, hobbyists, and general automotive applications
- Design allows for use of magnifier plate
- Meets and exceeds **ANSI Z87.1** and **CAN/CSA-Z94.3** standards
- **CE certified**

SERIES NAME	Filter Dimensions	Viewing Area	Shade Range	Power Control	Shade Control	Switching Speed	Sensitivity	Delay	Dark to Light	No. of Sensors
S26100	3.54" x 4.33"	1.57" x 3.54"	4, 9 to 13	Automatic	External	0.1ms	L/M/H	S/M/F	0.1s/0.5s/0.9s	4

PRODUCT NO.	Description
S27710	Replacement ADF Filter
S27005	Replacement Headgear
S19451	Replacement Cover Plates

- Arc flash is a painful condition that can occur if eyes are unprotected and exposed to welding arc rays. To prevent this, make sure to wear a helmet fitted with the proper filter shade, based on your welding application.
- Make sure you don't have any exposed skin while welding, and get fitted with proper personal protective gear.
- Always make sure your work area is clear of flammable materials and debris.
- When leaving your work area, make sure your equipment is turned off and secure.

JACKSON[®]
SAFETY

JACKSON SAFETY

WELDING HELMETS -
SPECIALTY PASSIVE



WELDING HELMETS – SPECIALTY



Huntsman Leather Welding Helmet

- Heat resistant and flexible leather design
- Ideal for use in overhead welding applications or when working in tight spaces
- 14531 meets or exceeds **ANSI Z87.1** and **CAN/CSA Z94.3** standards

PRODUCT NO.	Old Code	Description	Case Qty.
14531	3000506	860P Leather Welding Helmet – 2" x 4.25" Lift Front (headgear included)	4
26035	3000507	860P-2 Leather Welding Helmet – 2" x 4.25" Lift Front (headgear not included)	1
16073	3002759	Replacement Safety Plate – 2" x 4.25"	25
14556	3000621	117A Replacement Headgear	6
24557	3024222	860P Parts Kit	1



14531

2" x 4.25" format

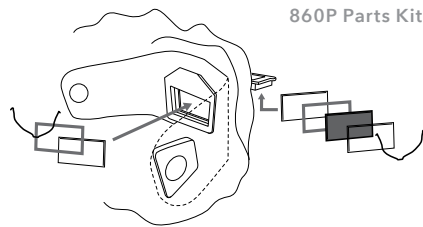

860P Parts Kit

Tough, pliable, and breathable leather covering

Headgear teeth automatically disengage during adjustment for speed and ease

Lift front style for added convenience

All around protection ideal for working in close proximity with other welders



14531



S21301



S29411-08E



S21100

WELDING HELMETS – SPECIALTY



Leather Hooded Welding Helmet

- Special leather welding hood is ideal for confined space applications and wherever risk of welding sparks are present, not only in the face area, but around the rest of the head, neck, and shoulders
- Extra-long bib for under-chin protection from sparks and spatter
- Extremely durable heat- and flame-resistant gray leather material
- Leather hood is permanently attached to specially designed sure-fit headgear platform using six metal-plated rivets
- Four stainless-steel top ventilation holes with built-in screens for user comfort
- Complete with ratcheting headgear suspension with sweatband included (S27051)
- Comes with standard 2" x 4.25" spring-loaded positive lock lift-front option
- Meets or exceeds **ANSI Z87.1** and **CAN/CSA Z94.3** standards

2" x 4.25"
format

PRODUCT NO.	Type	Bezel Type	Headgear	Filter
S21301	Leather hooded	Lift front	Ratcheting	None
S21301-10	Leather hooded	Lift-front	Ratcheting	Shade 10 plate

Confined Space Welding Helmet/Hood

- Modified 290 Series welding helmet features replaceable top and bottom (two separate pieces) leather bib protectors (replacement #21100)
- Originally designed for shipbuilding applications including submarine work, this helmet has since proven effective for other tight/confined space applications
- Patented Sel-Snap lens retention system provides easy loading of filter, cover, and protective plates
- Features our proprietary **Super Kool silver coating** which keeps the helmet 30% cooler than standard helmets and sheds spatter without burning
- Provides maximum operator comfort and safety
- Complete with Sellstrom's patented "quick release" ratchet headgear suspension with sweatband included (S27001)
- Comes with standard 2" x 4.25" spring-loaded positive lock lift-front option
- Meets or exceeds **ANSI Z87.1** and **CAN/CSA Z94.3** standards

2" x 4.25"
format

PRODUCT NO.	Type	Bezel Type	Headgear	Filter
S29411-08E	Confined Space	Lift front	Ratcheting	None

Welding Helmet Accessories and Replacement Parts

PRODUCT NO.	Description
S21100	Welder's Leather Bibs with Velcro Tabs (fits inside most welding helmets, and a replacement part for Sellstrom S29411-08E)
S21300	4.5" x 5.25" Spring-Loaded Positive Lock Lift-Front Adapter for 290 Series Helmets
S22450	450 Sweatband All-Purpose Sweatbands
S27000	Replacement Sweatbands for Ratcheting Headgear Suspensions
S27001	Replacement Ratcheting Headgear for Sellstrom's 280, 290, Titan, and Trident Series Welding Helmets (meets ANSI Z87.1 standards)

Please note: To attach Sellstrom welding helmets to slotted hard hats, use **#S61970** universal slotted dielectric hard hat adaptor. Please consult the **Face Protection/Face Shields** section of our catalog under **Face Shield Hard Hat Adaptor Brackets** for full details.



WELDING HELMETS – SPECIALTY

MADE IN
USA

Iron Mask Hand-Held Welding Shield

- Sellstrom's USA-made exclusive Iron Mask hand-held welding shield is used for temporary viewing of welding applications
- Removable cap allows for protection when used in right or left hand
- Lightweight and easy to hold in either hand
- Opening fits any sized gloved hand
- Comes with standard 2" x 4.25" Shade 10 filter plate and cover plate
- Meets or exceeds **ANSI Z87.1** and **CAN/CSA Z94.3** standards

2" x 4.25"
format

PRODUCT NO.	Description
S25000-10	Iron Mask Hand-Held Welding Shield



S25000-10



14979



14982

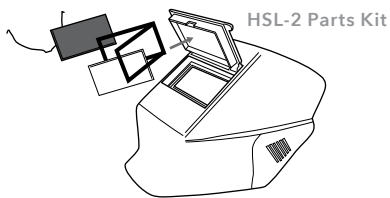

HSL-2 Parts Kit



Hard Hat Interchange System

Look for this symbol for helmets compatible with the Hard Hat Interchange System

WELDING HELMETS – HSL PASSIVE SERIES

HSL-1 Passive Welding Helmet

- Narrow shell design is perfect for work in tight spaces
- Extended front increases throat protection from sparks, slag, and other physical hazards
- Hard hat adaptable using 187-S (15968)
- Meets or exceeds **ANSI Z87.1** and **CAN/CSA Z94.3** standards



2" x 4.25" format

PRODUCT NO.	Old Code	Description	Case Qty.
14979	3002503	HSL-1 Passive Welding Helmet, Black – 2" x 4.25"	4
15121	3002579	HSL-1 Passive Welding Helmet, Black – 2" x 4.25" (bulk)	10
16073	3002759	Replacement Safety Plate – 2" x 4.25"	25
20696	3014866	370 Replacement Headgear	1
32187		Replacement Washable Sweatband – 2/pack	24 packs

HSL-2 Passive Welding Helmet – Lift Front

- Narrow shell design is perfect for work in tight spaces
- Extended front increases throat protection from sparks, slag, and other physical hazards
- Hard hat adaptable using 187-S (15968)
- Meets or exceeds **ANSI Z87.1** and **CAN/CSA Z94.3** standards



2" x 4.25" format

PRODUCT NO.	Old Code	Description	Case Qty.
14982	3002507	HSL-2 Passive Welding Helmet, Black – 2" x 4.25" Lift Front	4
15132	3002580	HSL-2 Passive Welding Helmet, Black – 2" x 4.25" Lift Front (Bulk)	10
14986	3002512	HSL-2 Passive Welding Helmet, Black With 187 Blades – 2" x 4.25" Lift Front	4
14972	30102490	HSL-2 Passive Welding Helmet, Black With 386 Cap Adapter – 2" x 4.25" Lift Front	4
16073	3002759	Replacement Safety Plate – 2" x 4.25"	25
20696	3014866	370 Replacement Headgear	1
24523	3024123	HSL-2 Parts Kit	1
32187		Replacement Washable Sweatband – 2/pack	24 packs

- Features legendary Jackson HSL Shadow helmet shell
- HSL-1 and HSL-2 helmets come with a 14560 2" x 4.25" Shade 10 filter as standard. See pages 51–53 for Jackson "drop-in" ADF options, and pages 54–56 for the full range of replacement passive filters, cover, and magnifier plates

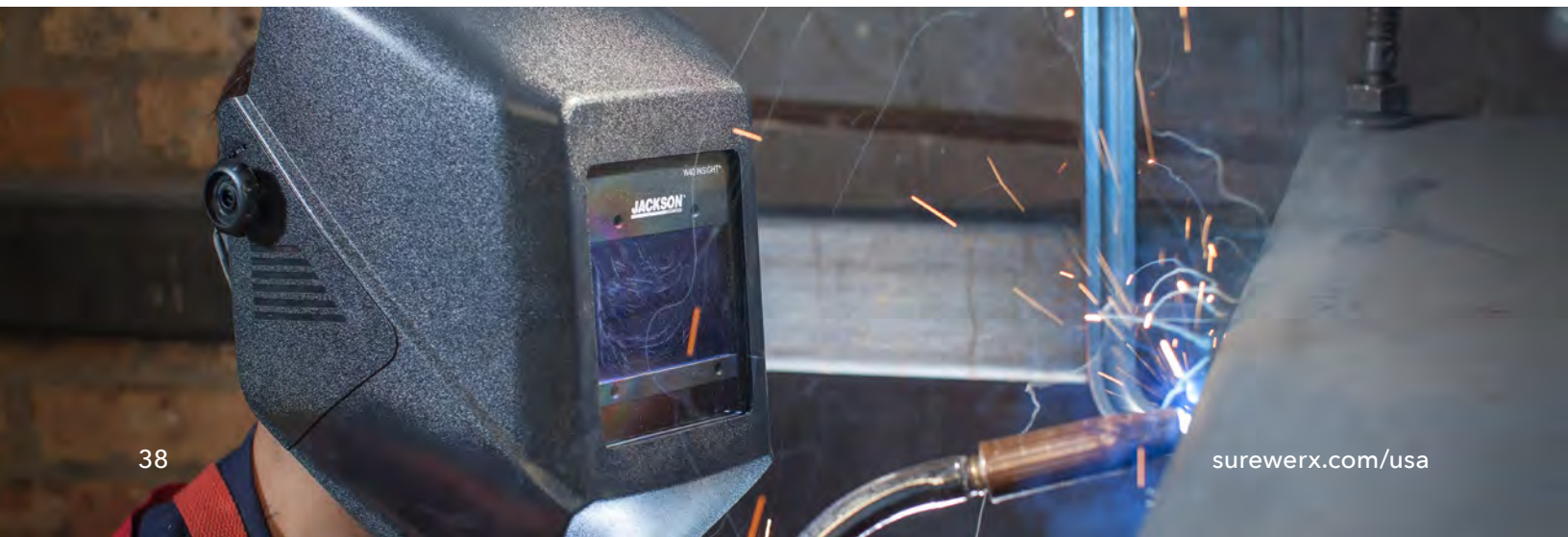

WELDING HELMETS – HSL PASSIVE SERIES

HSL-100 Passive Welding Helmet

- Narrow shell design is perfect for work in tight spaces
- Extended front increases throat protection from sparks, slag, and other physical hazards
- Hard hat adaptable using 187-S (15968)
- ADF adaptable
 - NexGen®
 - Insight®
- Meets or exceeds **ANSI Z87.1** and **CAN/CSA Z94.3** standards

4.5" x 5.25"
format

MADE IN
USA **370**
SPEED DIAL™

PRODUCT NO.	Old Code	Description	Case Qty.
14975	3002498	HSL-100 Passive Welding Helmet, Black – 4.5" x 5.25"	4
15134	3002581	HSL-100 Passive Welding Helmet, Black – 4.5" x 5.25" (bulk)	10
14976	3002499	HSL-100 Passive Welding Helmet, Blue – 4.5" x 5.25"	4
14977	3002500	HSL-100 Passive Welding Helmet, Red – 4.5" x 5.25"	4
14978	3002502	HSL-100 Passive Welding Helmet, Black with 187 Blades – 4.5" x 5.25"	4
14973	3002491	HSL-100 Passive Welding Helmet, Black with 386 Cap Adapter – 4.5" x 5.25"	4
16642	3004736	Replacement Light Leak Gasket	12
16078	3002760	Replacement Safety Plate – 4.5" x 5.25"	25
20696	3014866	370 Replacement Headgear	1
24550	3024209	HSL-100 Parts Kit	1
15974	3002647	Magnifier (Cheater Lens) Adapter	12
32187		Replacement Washable Sweatband – 2/pack	24 packs

- Features legendary Jackson HSL Shadow helmet shell
- HSL-100 and HLX-100 helmets come with a 14563 4.5" x 5.25" Shade 10 filter as standard. See pages 54–56 for the full range of replacement passive filters, cover and magnifier plates

WELDING HELMETS – HLX PASSIVE SERIES

HLX-100 Passive Welding Helmet – Ultra Lightweight

- Ultra lightweight shell — only weighs 6 ounces
- Lightweight shell helps reduce neck tension
- Hydraflex® shell provides the ultimate in flexibility and durability
- Hard hat adaptable using 187-S (15968)
- ADF adaptable
 - NexGen®
 - TrueSight II
 - Insight®
- Meets or exceeds **ANSI Z87.1** and **CAN/CSA Z94.3** standards

4.5" x 5.25"
format

370
SPEED DIAL™

PRODUCT NO.	Old Code	Description	Case Qty.
20508	3013597	HLX-100 Passive Welding Helmet, Heavy Metal – 4.5" x 5.25"	2
24737	3024543	HLX-100 Passive Welding Helmet, Carbon Fiber – 4.5" x 5.25"	2
34068		HLX-100 Passive Welding Helmet, Black – 4.5" x 5.25"	2
16078	3002760	Replacement Safety Plate – 4.5" x 5.25"	25
20696	3014866	370 Replacement Headgear	1
24550	3024209	HSL-100 Parts Kit	1
15974	3002647	Magnifier (Cheater Lens) Adapter	12
32187		Replacement Washable Sweatband – 2/pack	24 packs

- Features legendary Jackson HLX Halo X helmet shell
- HSL-100 and HLX-100 helmets come with a 14563 4.5" x 5.25" Shade 10 filter as standard. See pages 54–56 for the full range of replacement passive filters, cover and magnifier plates

JACKSON
SAFETY



14975

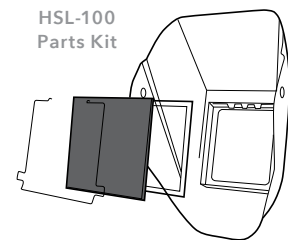

HSL-100
Parts Kit



20508



Black

Heavy
Metal

Carbon Fiber



**Hard Hat
Interchange
System**

Look for this symbol for helmets compatible with the Hard Hat Interchange System



14528



14532



14527



14529

WELDING HELMETS – HUNTSMAN SERIES



430P Fiber Shell Welding Helmet



FOR HIGH HEAT APPLICATIONS

- Features a lightweight vulcanized fiber shell for comfortable, yet cool, heavy-duty welding
- Made of 10% recycled fiber content
- Not suited for damp environments or overhead welding
- Lift front provides flexibility so user does not have to raise hood
- Meets or exceeds ANSI Z87.1 and CAN/CSA Z94.3 standards

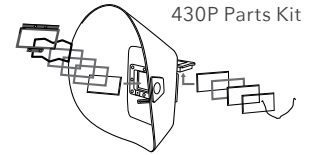

PRODUCT NO.	Old Code	Description	Case Qty.
14528	3000499	430P Fiber Shell Welding Helmet – 2" x 4.25" Lift Front	4
16073	3002759	Replacement Safety Plate – 2" x 4.25"	25
14556	3000621	117A Replacement Headgear	6
24528	3024139	430P Parts Kit	1

490P Fiber Shell Welding Helmet



FOR HIGH HEAT APPLICATIONS

- Features a lightweight vulcanized fiber shell for comfortable, yet cool, heavy-duty welding
- Made of 10% recycled fiber content
- Not suited for damp environments or overhead welding
- Quick-slide filter plate holder is ideal for tight work environments
- Meets or exceeds ANSI Z87.1 and CAN/CSA Z94.3 standards

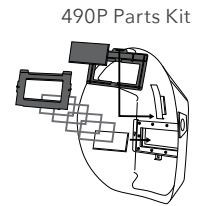

PRODUCT NO.	Old Code	Description	Case Qty.
14532	3000499	490P Fiber Shell Welding Helmet – 2" x 4.25" Quick Slide	4
16073	3002759	Replacement Safety Plate – 2" x 4.25"	25
14556	3000621	117A Replacement Headgear	6
24551	3024210	490P Parts Kit	1

411P Fiber Shell Welding Helmet



FOR HIGH HEAT APPLICATIONS

- Features a lightweight vulcanized fiber shell for comfortable, yet cool, heavy-duty welding
- Made of 10% recycled fiber content
- Not suited for damp environments or overhead welding
- Fixed front with aluminum frame filter plate holder
- Meets or exceeds ANSI Z87.1 and CAN/CSA Z94.3 standards

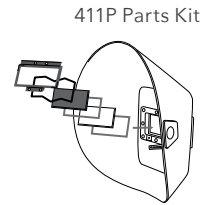

PRODUCT NO.	Old Code	Description	Case Qty.
14527	3000496	411P Fiber Shell Welding Helmet – 2" x 4.25"	4
16073	3002759	Replacement Safety Plate – 2" x 4.25"	25
14556	3000621	117A Replacement Headgear	6
24530	3024141	411P Parts Kit	1

451P Fiber Shell Welding Helmet



FOR HIGH HEAT APPLICATIONS

- Features a lightweight vulcanized fiber shell for comfortable, yet cool, heavy-duty welding
- Made of 10% recycled fiber content
- Not suited for damp environments or overhead welding
- Meets or exceeds ANSI Z87.1 and CAN/CSA Z94.3 standards

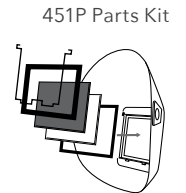

PRODUCT NO.	Old Code	Description	Case Qty.
14529	3000500	451P Fiber Shell Welding Helmet – 4.5" x 5.25"	4
16073	3002759	Replacement Safety Plate – 2" x 4.25"	25
14556	3000621	117A Replacement Headgear	6
24565	3024236	451P Parts Kit	1

WELDING HELMETS – HUNTSMAN SERIES

HUNTSMAN
SERIES

951P Passive Welding Helmet

- Lightweight, durable, washable thermoplastic shell
- Meets or exceeds **ANSI Z87.1** and **CAN/CSA Z94.3** standards

MADE IN USA

951P Parts Kit

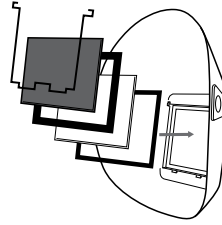

PRODUCT NO.	Old Code	Description	Case Qty.
14535	3000512	951P Passive Welding Helmet – 4.5" x 5.25"	4
16078	3002760	Replacement Safety Plate – 4.5" x 5.25"	25
14556	3000621	117A Replacement Headgear	6
15974	3002647	Magnifier (Cheater Lens) Adapter	12
24548	3024206	951P Parts Kit	1

930P Passive Welding Helmet

- Lightweight, durable washable thermoplastic shell
- Lift front filter eliminates need to raise welding helmet
- Meets or exceeds **ANSI Z87.1** and **CAN/CSA Z94.3** standards

MADE IN USA

930P Parts Kit

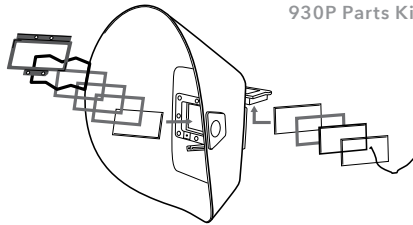

PRODUCT NO.	Old Code	Description	Case Qty.
14534	3000511	930P Passive Welding Helmet – 2" x 4.25"	4
16073	3002759	Replacement Safety Plate – 2" x 4.25"	25
14556	3000621	117A Replacement Headgear	6
24528	3024139	930P Parts Kit	12

Thermoplastic construction is lightweight and washable

Headgear teeth automatically disengages during adjustment for speed and ease

Lift front eliminates the need to raise welding helmet

Comes complete with cover plate and Shade 10 filter

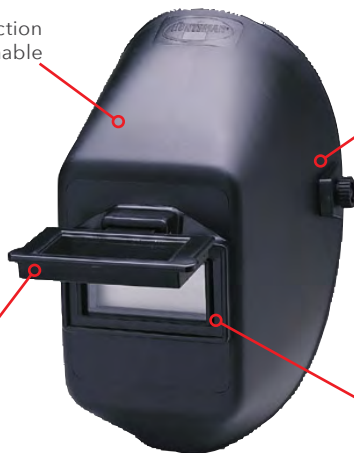

JACKSON
SAFETY

JACKSON SAFETY

WELDING HELMETS – PASSIVE



14535



14534



14534

Please note: All Huntsman helmets listed on pages 42 and 43 come complete with Jackson Shade 10 passive filters (2" x 4.25" = 14560, 4.5" x 5.25" = 14563). See pages 51–54 for Jackson "drop-in" ADF options, and pages 54–56 for the full range of replacement passive filters, cover, and magnifier plates.

sellstrom.

SELLSTROM

WELDING HELMETS - PASSIVE



WELDING HELMETS – 280 SERIES

- Sellstrom’s 280 Series welding helmets have been an industry leader for decades
- **Made in the USA**, the 280 Series is a traditional bucket style welding helmet
- Molded from Super Tuff nylon — lighter than fiberglass and extremely durable
- Patented Sel-Snap lens retention system provides easy loading of filter, cover and protective plates
- Available in standard 2" x 4.25" lift and fixed front versions
- Lift front version comes standard with spring loaded positive lock feature
- Also available in 4.5" x 5.25" fixed front version
- Available with our proprietary Super Kool silver coating which keeps the helmet 30% cooler than standard helmets and sheds spatter without burning
- Provides maximum operator comfort and safety
- Available with Sellstrom’s patented “quick-release” ratchet headgear suspension with sweatband included, or with universal slot adaptors for slotted hard hats
- Specially designed shape for use with cartridge respirators
- Meets or exceeds **ANSI Z87.1** and **CAN/CSA Z94.3** standards

280 Series – 2" x 4.25" Welding Helmets Only

- 2" x 4.25" welding helmet only (without filter)



PRODUCT NO.	Color	Bezel Type	Headgear	Helmet Coating
S28301	Black	Lift front	Ratcheting	None
S28311	Silver	Lift front	Ratcheting	Super Kool Silver
S28501	Black	Fixed front	Ratcheting	None



S28311

Designed for use with respirators



S28301



S28501



WELDING HELMETS – 290 SERIES



290 Series Welding Helmets

- Sellstrom's 290 Series welding helmets have been an industry leader for decades
- **Made in the USA** — our most popular passive welding helmet series
- Molded from Super Tuff nylon — lighter than fiberglass and extremely durable
- Extended crown provides greater overhead protection
- Specially designed rigid neck bib provides superior protection from spatter
- Patented Sel-Snap lens retention system provides easy loading of filter, cover, and protective plates
- Available in standard 2" x 4.25" and 4.5" x 5.25" lift and fixed front options
- Available in four popular colors
- Available with our proprietary Super Kool silver coating which keeps the helmet 30% cooler than standard helmets and sheds spatter without burning
- Provides maximum operator comfort and safety
- Complete with Sellstrom's patented "quick-release" ratchet headgear suspension with sweatband included (S27001)
- Can also be mounted on slotted hard hats using Sellstrom's dielectric universal slot adaptor (S61970)
- Sold without filter or with a variety of ADF options (your choice)
- Meets or exceeds **ANSI Z87.1** and **CAN/CSA Z94.3** standards

290 Series – 2" x 4.25" Welding Helmets Only

- 2" x 4.25" welding helmet only (without filter)

PRODUCT NO.	Color	Bezel Type	Retention System	Helmet Coating
S29301	Black	Lift front	Sel-Snap	None
S29311	Silver	Lift front	Sel-Snap	Super Kool Silver
S29341	Blue	Lift front	Sel-Snap	None
S29371	Red	Lift front	Sel-Snap	None



S29301



S29901

290 Series – 4.5" x 5.25" Welding Helmets Only

- 4.5" x 5.25" welding helmet only (without filter)

PRODUCT NO.	Color	Bezel Type	Retention System	Helmet Coating
S29901	Black	Fixed front	Sel-Snap	None
S29911	Silver	Fixed front	Sel-Snap	Super Kool Silver



sellstrom®

SELLSTROM

WELDING HELMETS - PASSIVE



15968



14939

14961



15973



Hard Hat Interchange System

WELDING HELMET/HARD HAT MOUNTING SYSTEMS

187-S Mounting Blades

- Securely attaches a welding helmet to safety cap
- Positive locking device keeps the helmet in any position
- Quick detach brackets

PRODUCT NO.	Old Code	Description	Case Qty.
15968	3002634	187-S Mounting Kit	12

187-S Can Be Used With	SC-6	Sentry III®	Charger®
HLX Series	•	•	•
HSL Series Shadow	•	•	•
Nitro®	•	•	•

87 Mounting Blades

- Attaches H, HSL, and Nitro Series welding helmets safely and securely to a hard hat
- Must use with metal 86-M (#14961) quick detach pins (sold separately)
- Fits Jackson SC-6 hard hat series









386 Cap Adapter

- Lets you attach any H Series fiberglass or HSL welding helmet safely and securely to a hard hat

PRODUCT NO.	Old Code	Description	Case Qty.
15973	3002645	386 Capmount Adapter	12

	CODE	Description	Case Qty.
 <p>Helmet not included</p>	38426	HHIS Welding Helmet Kit contains all components necessary to mount welding helmets to your hard hat	6

Compatibility Chart

SHELL	Halo X	HSL-100	HSL-1	HSL-2	951P	990P	930P	860P	430P	490P	411P	451P	WH40	Nitro®	NexGen®
	187-S	187-S	187-S	187-S										187-S	
	386	386	386	386										386	
	 20696	 20696	 20696	 20696	117A	117A	117A	117A	117A	117A	117A	117A	WH40	 20696	 20696
	•	•	•	•											•

EXCLUSIVE!

Hard Hat Interchange System

The All-In-One Safety Solution. Injuries can happen in a split second. Now it's easy to stay protected with the Jackson Safety® Hard Hat Interchange System. It lets you add, remove, or switch between your face shield or welding helmet, without removing your head protection.

In accordance with ANSI Z87.1, the system was designed to protect against multiple combinations of hazards. Remain safe, productive, and compliant with the Hard Hat Interchange System. It's worker preferred and safety manager enforced.

- Quickly switch between face shields and welding helmets without removing hard hats
- Meets ANSI standards when PPE products are used separately or combined
- Hear the audible click — Know your PPE is assembled correctly without the need for visual inspection
- One-button action provides quick release
- Vertical lock-in eliminates the annoyance of helmet creep
- HHIS headgear system comes fully assembled and ready to use
- Made from lightweight polypropylene
- Dielectric — Keeps your hard hat Class E rated!

	CODE	Description	Case Qty.
	39477	HHIS Master Kit contains all components necessary to mount welding helmets and face shields to your hard hat	6
	38423	Replacement HHIS kits for 14225/14235/14238 QUAD 500™	6
	38424	Replacement HHIS kits for 14202/14203 MAXVIEW™ and 14260/14262 F4XP	6
	38425	HHIS Face Shield Kit contains all components necessary to mount face shields to your hard hat	6
 Helmet not included	38426	HHIS Welding Helmet Kit contains all components necessary to mount welding helmets to your hard hat	6
	39476	Replacement mounting brackets for SC-6 series hard hats	6

Look for the Hard Hat Interchange System (HHIS) on these new Jackson products:



MAXVIEW™



14202, 14203

Quad 500™



14225, 14235, 14238

JACKSON
SAFETY



It's as Easy as 1, 2, 3!

1



Attach HHIS hard hat mounting bracket (with exclusive quick release button) to cap style slotted hard hat.

2



Attach HHIS hard hat mounting blades to any Jackson face shield or welding helmet product.

3



Pushing the HHIS quick release button allows fast and easy attachment/removal of face protection without ever removing your hard hat!



HHIS Mounting Brackets

HHIS Mounting Blades

JACKSON[®]
SAFETY

A JACKSON EXCLUSIVE!

JACKSON SAFETY

DROP-IN ADFS



AUTO DARKENING FILTERS – 2" x 4.25" REPLACEMENT (DROP-INS)

Replacement or "drop-in" ADFs are designed to fit most 2" x 4.25" welding helmets, including Jackson's popular HSL-1, HSL-2, and Huntsman Series, and the Sellstrom 280 and 290 Series. They are an economical replacement ADF filter, or an ideal method to upgrade passive welding helmets into an ADF format. Jackson introduces two new models, the exclusive Smartweld®, which incorporates a convenient USB-C rechargeable system and variable shade ranges from 4/9-13, and the more economical Solera® II offering a fixed 3/11 shade range. Both offer True Color technology and are TIG rated >5 amps. The best in the business – now from Jackson!

NEW!

Smartweld Variable Shade ADF

- The Smartweld is a newly innovative product that can be recharged!
- ADF is compatible with a USB-C charger
- Charge time four hours
- Charge lasts approximately one month of usage (160 hours)
- TIG amp rated >5A
- Comes in attractive, ready-to-use color POP counter display — 10 pieces/display
- Meets or exceeds **ANSI Z87.1** and **CAN/CSA Z94.3** standards. **CE certified**
- A Jackson Safety exclusive!

PRODUCT NO.	Description	Case Qty.
46411	Smartweld ADF, USB-C Rechargeable, Shade 4/9-13, 2" x 4.25"	10
46911	Smartweld Internal Safety Plate, 2" x 4.25"	100



46411

PRODUCT NO.	Filter Dimensions	Viewing Area	Shade Range	True Color	Modes	Optical Clarity	Switching Speed	Controls	Weight	No. of Sensors	TIG Rating	Warranty
46411	2" x 4.25"	1.42" x 3.62"	4, 9 to 13	Yes	Welding	1/1/1/2	1/1,667 sec.	Analog	1.4 oz.	2	>5A	1 year

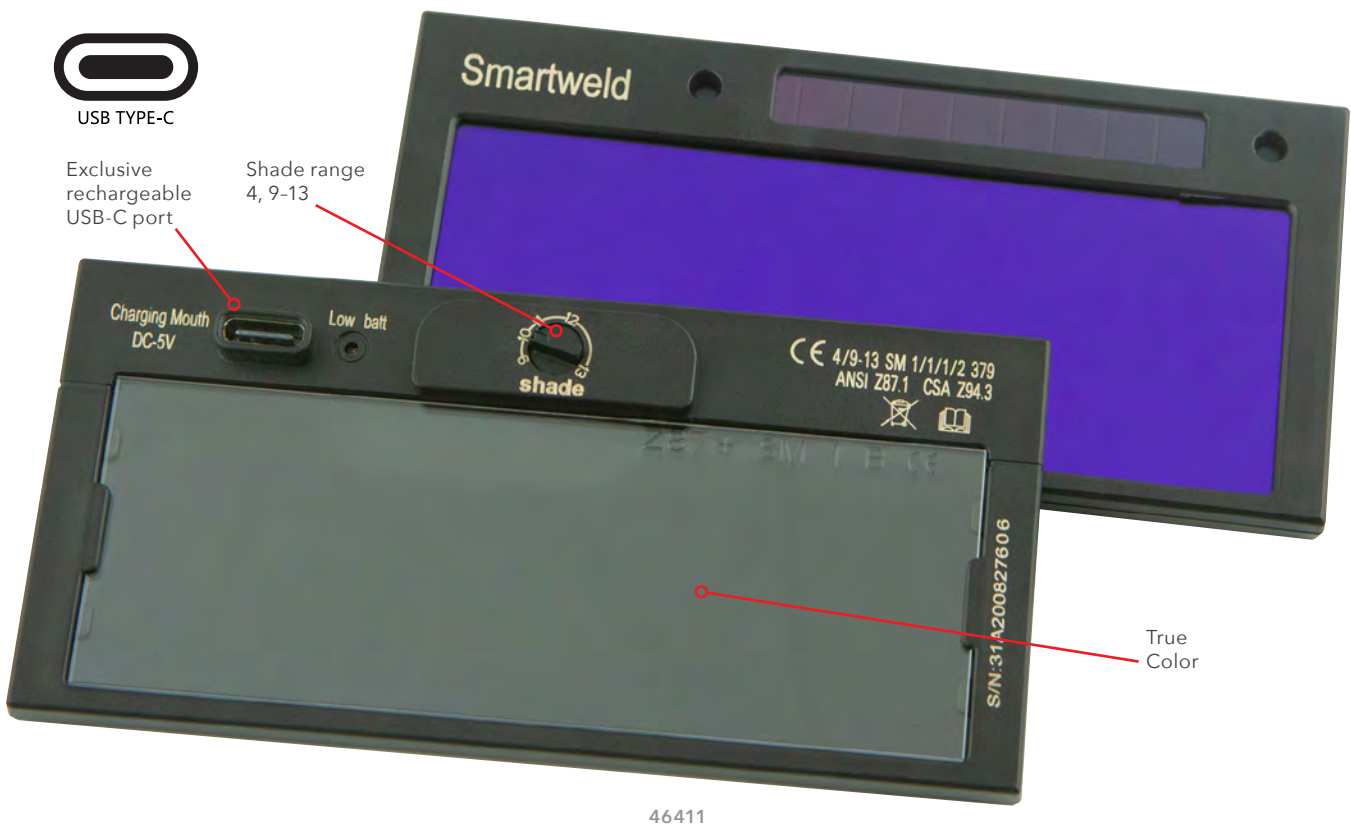

46411

JACKSON[®]
SAFETY

JACKSON SAFETY

DROP-IN ADFS



AUTO DARKENING FILTERS – 2" x 4.25" REPLACEMENT (DROP-INS)

JACKSON
SAFETY

Solera II Shade 10 Welding ADF

NEW!

- The Solera II improves upon the highly demanded Solera product
- The ADF is a universal fit for most 2" x 4.25" welding helmets
- Compatible with HSL-1, HSL-2, and Huntsman series and many other brands of welding helmets
- Sleek, ultralight design at only 1.3 oz. will ensure maximum comfort
- Solar powered
- Comes in attractive, ready-to-use color POP counter display — 10 pieces/display
- Meets or exceeds **ANSI Z87.1** and **CAN/CSA Z94.3** standards. **CE certified**



46410

PRODUCT NO.	Description	Case Qty.
46410	Solera II ADF Shade 3/10, 2.5" x 4.25"	10
46910	Solera II Internal Safety Plate, 2" x 4.25"	100

PRODUCT NO.	Filter Dimensions	Viewing Area	Shade Range	True Color	Modes	Optical Clarity	Switching Speed	Controls	Weight	No. of Sensors	TIG Rating	Warranty
46410	2" x 4.25"	1.42" x 3.62"	3, 10	Yes	Welding	1/1/1/2	1/1,667 sec.	N/A	1.3 oz.	2	>5A	1 year

Ultra lightweight
1.3 oz.

True
Color



Fits majority of
2" x 4.25" helmets

46410



S16605

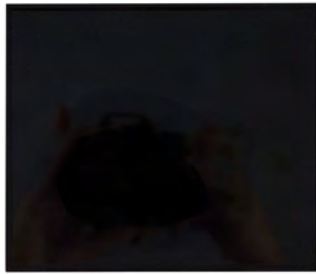

S16709

WELDING FILTER PLATES – PASSIVE

- Traditional welding filter plates are widely used in the industry
- Unlike auto-darkening filters, welding filter plates are a passive fixed shade system — you choose the right filter shade for your application as mandated by ANSI Z49.1-2005 standards
- Available in two common sizes: 2" H x 4.25" W and 4.5" H x 5.25" W
- Available in a wide variety of materials and shades for every application
- These filters fit several Jackson and Sellstrom models, as well as most other welding helmets in the market

Polycarbonate Passive Filter Plates

- Polycarbonate passive filter plates offer outstanding impact strength and optical clarity
- The most popular passive filter plate in the market
- Meet **ANSI Z87.1 high impact** standards

PRODUCT NO.	Plate Size	Shade	Type	Case Qty.
S16604	2" x 4.25"	4 IR	Polycarbonate	50
S16605	2" x 4.25"	5 IR	Polycarbonate	50
S16606	2" x 4.25"	6 IR	Polycarbonate	50
S16609	2" x 4.25"	9 IR	Polycarbonate	50
S16610	2" x 4.25"	10 IR	Polycarbonate	50
S16611	2" x 4.25"	11 IR	Polycarbonate	50
S16612	2" x 4.25"	12 IR	Polycarbonate	50
S16709	4.5" x 5.25"	9 IR	Polycarbonate	15
S16710	4.5" x 5.25"	10 IR	Polycarbonate	15
S16711	4.5" x 5.25"	11 IR	Polycarbonate	15
S16712	4.5" x 5.25"	12 IR	Polycarbonate	15



14571



14562

Polycarbonate Passive Filter Plates

- Meets **ANSI Z87.1+ high impact** standards

PRODUCT NO.	Old Code	Description	Plate Size	Shade	Type	Case Qty.
14571	3000691	427 Filter Lens	2" x 4.25"	5 IR	Polycarbonate	25
14559	3000644	427 Filter Lens	2" x 4.25"	9 IR	Polycarbonate	25
14560	3000645	427 Filter Lens	2" x 4.25"	10 IR	Polycarbonate	25
14570	3000690	427 Filter Lens	2" x 4.25"	11 IR	Polycarbonate	25
14561	3000646	427 Filter Lens	2" x 4.25"	12 IR	Polycarbonate	25
14562	3000649	1127 Filter Lens	4.5" x 5.25"	9 IR	Polycarbonate	25
14563	3000650	1127 Filter Lens	4.5" x 5.25"	10 IR	Polycarbonate	25
14564	3000651	1127 Filter Lens	4.5" x 5.25"	11 IR	Polycarbonate	25
14566	3000652	1127 Filter Lens	4.5" x 5.25"	12 IR	Polycarbonate	25

COVER PLATES

- Cover plates are positioned in front of passive and ADF filters providing an economical “shield” that protects the more expensive filters plates from pitting and scratching
- As the cover plate becomes damaged, you simply replace it with a new plate

Cover Plates — CR-39 Long Life

- CR-39 clear cover plates provide the best protection from pitting and scratching
- Our most popular cover plates
- Made of durable, heat resistant materials containing CR-39 Monomer
- Combines the optics of glass with the added durability of thermostat material
- Superior resistance to scratches, heat and chemicals
- Meets **ANSI Z87.1** Basic Impact standards and **Federal Specs GGG-H-211D** (not to be used as an impact plate)
- Refractive Index Value — 1.498
- Abbe Value — 59.3
- Density — 1.31g/cm³
- Plate thickness — .056"
- Individually bagged

PRODUCT NO.	Plate Size	Shade	Type	Case Qty.
S19002	2" x 4.25"	Clear	CR-39	100/box
S19004	4.5" x 5.25"	Clear	CR-39	50/box

Cover Plates & Components

PRODUCT NO.	Old Code	Description	Size	Material	Case Qty.
16073	3002759	Replacement Safety Plates	2" x 4.25"	Polycarbonate	25 per Pack
16078	3002760	Replacement Safety Plates	4.5" x 5.25"	Polycarbonate	25 per Pack
16642	3004736	Light Seal Gasket	4.5" x 5.25"	Polycarbonate	12 per Pack
24734	3024540	Light Seal Gasket Inserted on Safety Plate	4.5" x 5.25"	Polycarbonate	10 per Pack

sellstrom®



S19002



S19004

JACKSON®
SAFETY



16073



16078



24734

sellstrom®



S18100

MAGNIFIER PLATES

- Magnifier plates are positioned behind either the passive or ADF welding filter
- Magnifier plates offer the feature of magnifying your vision, much like reading glasses for improved vision where necessary
- Made of high quality polycarbonate material
- Provide great visual clarity and scratch resistance characteristics
- Available in a wide range of dioptic ratings from 1.00–2.50

PRODUCT NO.	Plate Size	Shade	Dioptic Rating	Type	Case Qty.
S18100	2" x 4.25"	Clear	1.00	PC	1 ea. /200/box
S18125	2" x 4.25"	Clear	1.25	PC	1 ea. /200/box
S18150	2" x 4.25"	Clear	1.50	PC	1 ea. /200/box
S18175	2" x 4.25"	Clear	1.75	PC	1 ea. /200/box
S18200	2" x 4.25"	Clear	2.00	PC	1 ea. /200/box
S18225	2" x 4.25"	Clear	2.25	PC	1 ea. /200/box
S18250	2" x 4.25"	Clear	2.50	PC	1 ea. /200/box

JACKSON®

SAFETY



15974



15975

- Meets ANSI Z87.1+ high impact standards

Mag Plates

PRODUCT NO.	Old Code	Plate Size	Shade	Dioptic Rating	Case Qty.
16058	3002743	2" x 4.25"	Clear	1.50	6
16063	3002745	2" x 4.25"	Clear	2.00	6
16068	3002747	2" x 4.25"	Clear	2.50	6

Adapter Kits

PRODUCT NO.	Old Code	Description
15974	3002647	4.5" x 5.25" Mag Lens Holder
15975	3002656	Executive ADF Mag Lens Holder



USB TYPE-C

Exclusive rechargeable USB-C port

Shade range 4, 9-13

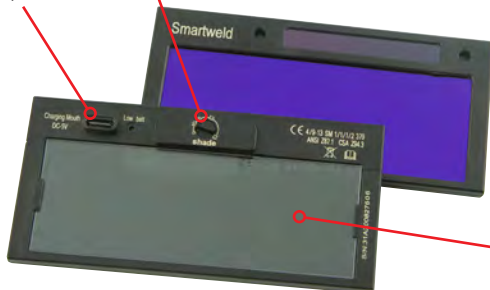

46411 Jackson Smartweld Variable Shade ADF (USB-C)

DID YOU KNOW?

Jackson carries two series of drop-in ADF filters for easy conversion of a passive welding helmet!

Ultra lightweight 1.3 oz.

Fits majority of 2" x 4.25" helmets

True Color



46410 Jackson Solera II Fixed Shade 10 ADF

For more details refer to pages 51–53

- Safety glasses with side protection are to be used under the helmet during all welding applications. These will protect the worker against flying metal, slag chips, grinding fragments, cutting debris and similar hazards that often ricochet under the users helmet.
- When choosing a welding helmet, make sure it meets the ANSI/CSA standards and that it is the right industrial grade for the weld job.
- Using a welding screen will reduce the amount of dangerous UV light that other workers are exposed to when welding is being performed.

JACKSON[®]

SAFETY

Long-levered, finger grip contoured handle for easy jaw opening

Extra large contact area for greater conductivity



Serrations cut through rust and contamination for superior connection

WELDING CONNECTORS, CLAMPS, AND ELECTRODES

GROUND CLAMPS

Jackson Safety[®] ground clamps feature large contact areas, high-clamping pressure and long-levered handles for easy jaw opening. Clamps have fully insulated pivots and springs. The cable jacket is held securely inside the conductor body with a cable bar for improved holding ability and longer cable life.

Ground Clamps

PRODUCT NO.	Old Code	Description	Jaw Opening	Cable Connection Cap.	Weight	Case Qty.
14730	3001834	GC-2	1.25"	4 through 1/0	16 oz.	24
14731	3001835	GC-3	1.625"	1/0 and 2/0	23 oz.	24
14732	3001836	GC-5	2"	3/0 and 4/0	34 oz.	12

Cable Lugs and Terminal Covers

PRODUCT NO.	Old Code	Description	Standard Pack
14748	3001855	Cable Lug QLB-45	Sold in pairs
14746	3001853	Terminal Covers	Sold in pairs



WELDING CONNECTORS, CLAMPS, AND ELECTRODES

Electrode Holders

PRODUCT NO.	Old Code	Description	Body Alloy	Electrode Capacity	Cable Connection Capacity	Weight	Duty Cycle Rating	Case Qty.
14679	3001793	JH-1	Copper Alloy	3/16"	4 through 1/0	12 oz.	Medium Duty	24
14683	3001797	JH-2	Aluminum Alloy	5/32"	4 through 1/0	10 oz.	Light Duty	24
14680	3001794	AW-C	Copper Alloy	1/4"	4 through 2/0	19 oz.	Medium Duty	24
14682	3001796	A-W	Aluminum Alloy	1/4"	3 through 2/0	14 oz.	Medium Duty	24
14681	3001795	A3-S	Copper Alloy	3/8"	2/0 through 4/0	30 oz.	Heavy Duty	12
14684	3001798	J-4	-	1/4"	2 through 1/0	16 oz.	Heavy Duty	12

Duty Cycle Rating is the maximum percentage of arc time (out of any 10-minute period) that a holder should be expected to perform comfortably.

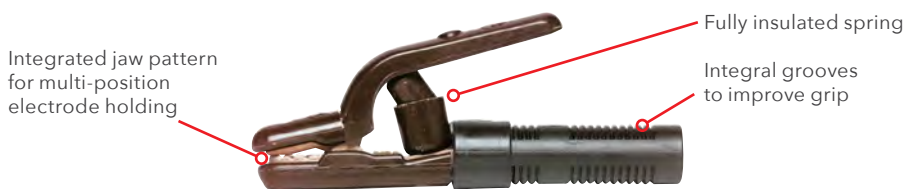

JACKSON
SAFETY



14679



14680



14681



14684

JACKSON SAFETY

WELDING EQUIPMENT

CABLE CONNECTORS

Jackson Safety® offers a popular range of fully insulated cable connectors with tapered ends covering the cable jacket and locking out moisture, oil and dirt.

Cable Connectors

PRODUCT NO.	Old Code	Description	Cable Connection Type	Connection Half Connection Type	Cable Connection Capacity	Standard Pack	Case Qty.
14742	3001849	Uni-Trik® UB-3-BP	Double Dome-Nose	Camlock	1/0 through 3/0	1 each Male & Female	6
14745	3001852	Uni-Trik® UB-4-BP	Double Dome-Nose	Camlock	3/0 through 4/0	1 each Male & Female	6
14733	3001840	Quick-Trik® QNB-2-BP	Single Dome-Nose	Camlock & Locking Bar	1/0 and 2/0	1 each Male & Female	6
14734	3001841	Quick-Trik® QNB-4-BP	Single Dome-Nose	Camlock & Locking Bar	3/0 and 4/0	1 each Male & Female	6

Uni-Trik®

Camlock secure connection mates the male and female halves

Form-fitted rubber jacket insulator protects against moisture, oil and dirt



Two large dome-nose screws for high-conductivity connection

Quick-Trik®

Camlock & Locking Bar draw together for virtually unbreakable connection

Form-fitted rubber jacket insulator protects against moisture, oil and dirt



Large dome-nose screw for high-conductivity connection

WORK WITH PRECISION

PIPE MARKERS

LEVELS AND FLANGE
ALIGNING TOOLS

WRAP-A-ROUND

CURV-O-MARK[®]

PIPE AND TOOL MARKING ACCESSORIES

Curv-O-Mark layout tools and systems have earned a reputation for quality and consistency across a wide range of industries. Easy to use and made for an extended working life, these are tools to help bring precision to any layout task.

Standard Markers

The Curv-O-Mark marker consists of an X-frame, calibrated protractor, and a triple-jointed marking arm adjustable to the line to be scribed. A soapstone crayon is required for each radius marker (not supplied).

U.S. PROD. NO.	EU Prod. No.	Description	Pipe Diameter	Case Qty.
14771	J1874	#1 Curv-O-Mark Marker – Standard	1.5" to 18" diameter	1
14772	J1875	#2 Curv-O-Mark Marker Combo Adaptor	Use with #1 Marker	1
14773	J1877	#4 Jumbo Curv-O-Mark Marker	8" to 48" diameter	1
14774	J1878	#5 Jumbo Marker Combo Adaptor	Use with #4 Marker	1

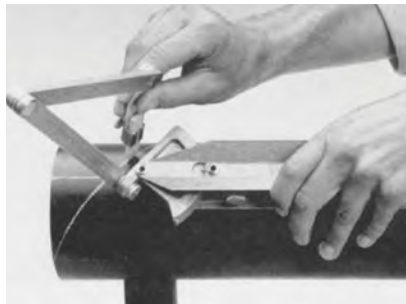
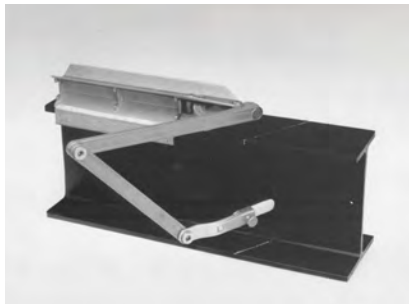

Radius Markers

Radius markers have sturdy friction joints to maintain rigidity and accuracy, and are made from lightweight, rustproof aluminum for extended life. A soapstone crayon is required for each radius marker.

U.S. PROD. NO.	EU Prod. No.	Description	Pipe Diameter	Case Qty.
14780	J1884	Radius Marker – Mini	Up to 8" in radius	1
14781	J1885	Radius Marker – Small	Up to 20" in radius	1
14782	J1886	Radius Marker – Standard	Up to 24" in radius	1
14783	J1887	Radius Marker – Jumbo	Up to 40" in radius	1

Centering Heads

Curv-O-Mark centering heads aid in the settings of centerlines, establishing angles and marks for butt-ins, locating points inside pipes and tanks, laying out keyways, and measuring declivity.

U.S. PROD. NO.	EU Prod. No.	Description	Pipe Diameter	Case Qty.
14775	J1879	#6 Centering Head – Standard	1/2" to 4" diameter	1
14776	J1880	#7 Centering Head – Jumbo	1"+ diameter	1

Protractor

This 90° protractor has a matching locking lever to set and hold the tool at the desired angle. It is equipped with a 5/8" x 10" tapered arm to complete finding of angles or desired bends, or to determine any portions of elbows. The tool is mounted in a 3/4"-wide frame with a 3/8" x 6" cast-in rod. It comes with a 25-lb. pull magnetic base for holding the protractor frame in position. The unit can be used manually or with a magnetic base.

U.S. PROD. NO.	EU Prod. No.	Description	Pipe Diameter	Case Qty.
14778	J1882	#9 Fitter Welding Protractor	All	1



14771

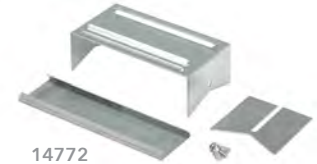

14772



14773



14774



14780

14781



14782



14783



14775

14776



14778



14785



14777



14786



14796



14779

PIPE MARKERS



Multi Trammel Heads

Using standard half-inch pipe as a trammel bar, heads feature radius set points cast in alignment with marking pointers for easy setting. Equipped with 1/4" screws and squared on the back side of perpendicular alignment. The stationary head holds a 1/4" case hardened center point. Movable head has a 1/8" steel scribe hardened. Marks from 1.5" circle to any diameter needed, depending on length of pipe used as a trammel bar. Allen wrench, soapstone, scribe, and pointer also included.

U.S. PROD. NO.	EU Prod. No.	Description	Pipe Diameter	Case Qty.
14785	J1890	#19 Multi Trammel Heads	All	1

LEVELS AND FLANGE ALIGNING TOOLS



Pro-Mag Level

A lightweight, easy to use tool for determining angles. Unit is ideal for the pipe fitter, welder, jig builder, or anyone who has to determine angles or do setup work. Includes two cast-in 25-lb. pull magnets that hold securely to any steel surface. Unit has a 360° adjustable DSL with two 90° quadrants graduated in 2.5° increments. Cast-in tables are used to convert degree-of-angle to rise-in-inches-per-foot or millimeters-per-meter. A groove on the bottom edge permits use on a small pipe.

U.S. PROD. NO.	EU Prod. No.	Description	Case Qty.
14777	J1881	#8 Pro Mag Level	1

Dial Angle Flange Level

A versatile tool that can be used as a dial degree utility level or, with attachments, for two holding flange alignment.

U.S. PROD. NO.	EU Prod. No.	Description	Case Qty.
14786	J1891	#20 Dual-Angle Flange Level – Non-magnetic; can be used on PVC Pipe	1

Universal Level

The universal level is a multi-purpose tool that features a 360° adjustable protractor dial that ensures accurate leveling and permits setting a predetermined pitch of a string of pipe, setting the angle of laterals to a precise degree, trueing vertical runs and two-holding flanges. For structural steel workers, the powerful holding magnets provide an extra hand. Electricians will find the level useful in laying out and lining up heavy conduit.

U.S. PROD. NO.	EU Prod. No.	Description	Case Qty.
14796	J1904	#33 Universal Level	1

Pipe Flange Aligner

Fast, accurate pipe construction is possible with this self-determining flange aligning tool. The aligner inserts easily into pipe, centers snugly against the inside pipe diameter and automatically aligns with the pipe axis.

U.S. PROD. NO.	EU Prod. No.	Description	Case Qty.
14779	JJ1883	#10 Pipe Flange Aligner	1

LEVELS AND FLANGE ALIGNING TOOLS



Universal Level

The DSL is an adjustable bubble protractor used with a number of Curv-O-Mark tools. The protractor covers 180° through two 90° quadrants, reading in 2.5° increments. The bubble is cast in the aluminum dial.

U.S. PROD. NO.	EU Prod. No.	Description	Pipe Diameter	Case Qty.
14797	J1905	Curv-O-Mark Dial-Set-Level (DSL)	Adjustable Bubble Protractor	1



14797

Flange Aligner Base

Removes the difficulty of flange aligning and squaring. Tool holds a square in the needed position without tying up one's hands. Base is notched at either end for ease in aligning on the center line of the pipe. Two 25-lb. pull, cast-in magnets for holding either a flat horizontal or vertical position. Base accepts either leg of a standard or combination aluminum square and works on pipe diameters from 1+", requiring only the extension of the legs of the square being used to accommodate larger diameters.

U.S. PROD. NO.	EU Prod. No.	Description	Case Qty.
14795	J1903	#32 Flange Aligner Base	1



14795

Centering Pin

A hardened steel pin for use with the standard centering head. Suitable for marking, but should not be used as a center punch.

U.S. PROD. NO.	EU Prod. No.	Description	Case Qty.
14798	J1906	Centering Pin	1



14798

WRAP-A-ROUND



Inexpensive tools for marking straight lines around pipe; made from flexible gasket material, providing resistance to both heat and cold. All Wrap-A-Rounds are available in two colors; these designate material type and service temperature. GG (gray) material is used for high temperature applications (up to 550°F) and B (black) material is used for temperatures up to 350°F. Both material types are asbestos free.

U.S. PROD. NO.	EU Prod. No.	Description	Color	Size	Pipe Diameter	Case Qty.
14752	J1858	Wrap-A-Round – Medium	Black	3.88" x 4'	3" to 6"	1
14753	J1859	Wrap-A-Round – Large	Black	3.88" x 6'	3" to 10"	1
14754	J1860	Wrap-A-Round – X-Large	Black	5" x 7'	4" to 12"	1
14756	J1861	Wrap-A-Round – XX-Large	Black	5" x 9'	6" to 16"	1
14763	J1867	Wrap-A-Round – Medium	Gray	3.88" x 4'	3" to 6"	1
14764	J1868	Wrap-A-Round – Large	Gray	3.88" x 6'	3" to 10"	1
14766	J1869	Wrap-A-Round – X-Large	Gray	5" x 7'	4" to 12"	1
14767	J1870	Wrap-A-Round – XX Large	Gray	5" x 9'	6" to 16"	1





JACKSON
SAFETY Group

WILSON[®]

WELDING CURTAINS & BLANKETS

6

ADVANTAGES OF WILSON® TRANSPARENT WELDING CURTAINS



● UV protection

Protects bystanders from UV and blue light radiation



● Injury prevention

Prevents sparks and spatter from injuring bystanders while self-extinguishing properties keep the curtain from burning



● Minimizes noise

Creates a sound barrier to minimize noise discomfort and the risk of hearing impairment for nearby workers



● Easy installation

Curtains come grommeted, and when used with frames, are easily hung and can be rearranged

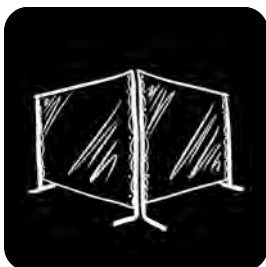

● Clear division

Creates a designated space specifically for welding operations while still maintaining visibility



● Reduced fumes and vapors

Creates a containment barrier that allows for more efficient fume extraction

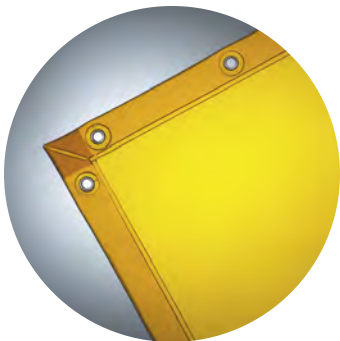
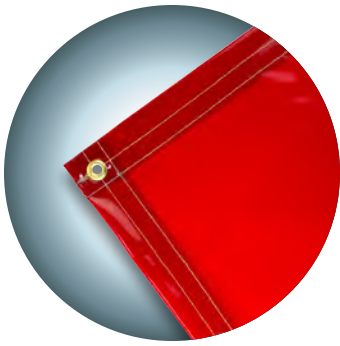

**Custom Size
Curtains Available**

TRANSPARENT WELDING CURTAINS

- Built with grommets for easy hanging
- Durable material resists tearing
- Flame, mildew, and water resistant
- All curtains meet or exceed California Fire Marshall standards or NFPA 701 requirements for flame resistance
- Available in orange, green, and gold 14-mil transparent material

Why Choose Orange?

- Puts light back into the welding area to help increase worker productivity
- Can be used around MIG, TIG, arc, and plasma operations
- Excellent for use in assembly areas

PRODUCT NO.	Width	Length	Weight	Thickness	Color	Amp Usage
36278	6' (1.8m)	10' (3m)	13 oz.	.014"	Orange	Medium-High
36292	6' (1.8m)	6' (1.8m)	13 oz.	.014"	Orange	Medium-High
36307	6' (1.8m)	8' (2.4m)	13 oz.	.014"	Orange	Medium-High
37606	6' (1.8m)	4' (1.2m)	13 oz.	.014"	Orange	Medium-High

Why Choose Green?

- Decreases total light from the welding arc
- Ideal when visibility and light reduction are necessary

PRODUCT NO.	Width	Length	Weight	Thickness	Color	Amp Usage
36283	6' (1.8m)	10' (3m)	13 oz.	.014"	Green	Medium-High
36299	6' (1.8m)	6' (1.8m)	13 oz.	.014"	Green	Medium-High
36315	6' (1.8m)	8' (2.4m)	13 oz.	.014"	Green	Medium-High
37700	6' (1.8m)	4' (1.2m)	13 oz.	.014"	Green	Medium-High

Why Choose Gold?

- Ideal when supervision is required
- Allows better two-way viewing between welder and bystander

PRODUCT NO.	Width	Length	Weight	Thickness	Color	Amp Usage
36281	6' (1.8m)	10' (3m)	13 oz.	.014"	Gold	Low-Medium
36296	6' (1.8m)	6' (2.4m)	13 oz.	.014"	Gold	Low-Medium
36312	6' (1.8m)	8' (2.4m)	13 oz.	.014"	Gold	Low-Medium
37607	6' (1.8m)	4' (1.2m)	13 oz.	.014"	Gold	Low-Medium

Why Choose Canvas?

- Made to withstand 500°F
- Excellent choice when zero visibility is required

PRODUCT NO.	Width	Length	Weight	Thickness	Color	Amp Usage
36277	6' (1.8m)	10' (3.0m)	12 oz	0.14"	Green	High
36289	6' (1.8m)	6' (1.8m)	13 oz	0.14"	Green	High
36304	6' (1.8m)	8' (2.4m)	13 oz	0.14"	Green	High
37454	6' (1.8m)	4' (1.2m)	13 oz	0.14"	Green	High

PRODUCT NO.	Description	Case Qty.
36687	Accessory hooks for hanging curtains to pipe frame configurations	10



WELDING SAFETY SCREENS

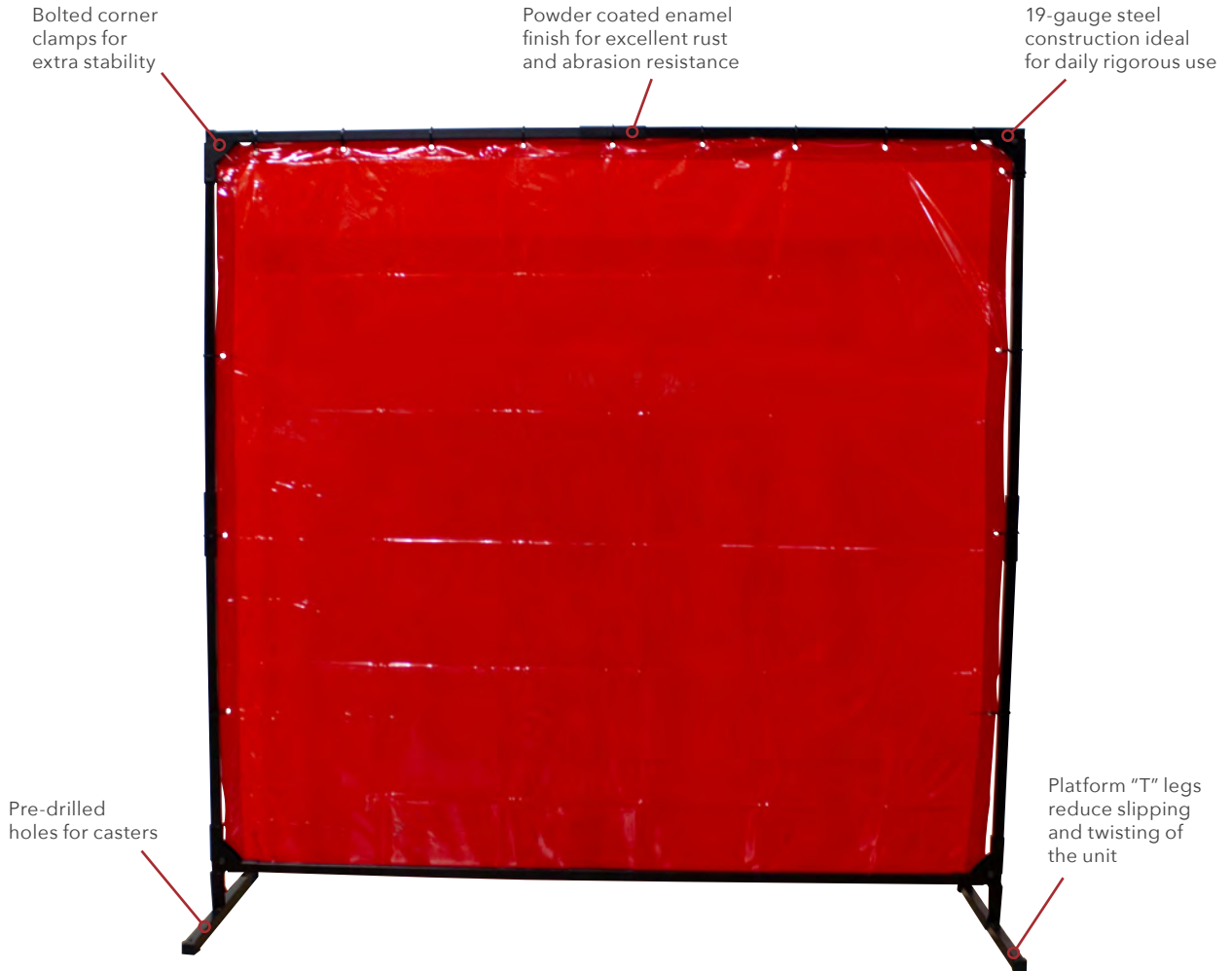

Per OSHA recommendations, allow 1' clearance at the floor for all curtain/frame combinations for ventilation

Stur-D-Screen Frames and Recommended Curtains

FRAME ONLY	Frame Size	Orange	Gold	Green
36335	6' x 4' Single Panel	37606	37607	37700
36336	6' x 6' Single Panel	36292	36296	36299
36338	6' x 8' Single Panel	36307	36312	36315
37198	Adjustable 6' x 6' to 6' x 8'	36292/36307	36296/36312	36299/36315
36333	6' x 10' Single Panel	36278	36281	36283

All Stur-D-Screens include steel frame, brackets, hardware and lacing ties

HOW DO I CHOOSE THE RIGHT WELDING BLANKET FOR THE JOB?

With so many different materials, sizes and functions, it's very difficult to decide what type of welding blanket you might need for the job. When you are unsure of the right style for you, it's good to start with some basic questions:

What constant, intermittent, and melting temperature are you working with?

- **Constant Temperature** — The maximum temperature a blanket can withstand for the entire duration of the application. Sometimes this is referred to as "service temperature" or "working temperature."
- **Intermittent Temperature** — The temperature the fabric can withstand for short durations without damage.
- **Melting Temperature** — The temperature where the fabric is physically damaged due to prolonged exposure.

What should I know about different fiberglass coatings?

There are many different coatings available each with its own specific properties. Listed below are some of the most common styles:

Acrylic

- Enhanced abrasion and tear resistance
- Soft to the touch

Silicone

- Resistant to oil and chemicals
- Non-slip surface
- Very flexible

Canvas

- Made to withstand 500°F
- Excellent choice when zero visibility is required

Carbon Fiber Felt

- Easy to cut and can conform to complex curves
- Lightweight and soft material

Vermiculite

- Advanced abrasion resistance
- Can be used without gloves

Which welding blankets are best for vertical and horizontal use?

Lighter duty welding blankets can be used vertically to offer protection against welding sparks and slag. If you are using a blanket horizontally or flat, it is recommended to use a heavier-duty blanket with a higher melt temperature as the spatter has the potential to rest directly on the material.



		Light Duty		Medium Duty		Heavy Duty	
PRODUCT SERIES	Welding Curtains	Acrylic Coated Fiberglass Blankets	Uncoated Fiberglass Blanket	Silicone Fiberglass Blankets	Vermiculite Blankets	Silica Cloth Blankets	Carbon Felt
Heat Resistant Temp	150°F	300°F	1000°F	500°F	1200°F	1800°F	1800°F
Colors	Gold, Orange/Red, Green, Blue (custom only)	Red and Yellow	White	Dark Red	Black	White	Black
Weight	13 oz.	16 oz. or 23 oz.	18 oz. or 24 oz.	32 oz.	24 oz.	18 oz.	16 oz.
Applications	Used in majority of welding environments to protect non-welders from UV rays	Slag resistance, spark resistance and incidental resistant to flames from cutting torches	Heat treating, low thermal conductivity, anti corrosion, and is a base material for coating, impregnating and laminating	Water resistant, oil-resistant and chemical resistant	Abrasion resistance, thermal barrier	Used for thermal and high heat requirements; can be used at 1800°F, melting pt 3000°F	Scratch resistant, flexible, used heavily in thermal insulation
Stress relief – up to 1700°F						✓	✓

NOTE: Temperatures and applications are intended as a guideline only and not a guarantee of performance. SureWerx recommends the use of welding blankets in multiple layers to attain proper molten metal and radiant heat protection. It is the user's responsibility to monitor the activity and use of blankets/high-heat materials at all times. The user must inspect the blankets before use. Abnormal wear and tear should be removed from service.



LIGHT DUTY PROTECTION

Welding Blankets Acrylic Coated Fiberglass

PRODUCT NO.	Product Type	Width	Length	Weight (per sq yd.)	Thickness	Color
36148	Roll	3' (.9m)	150' (45.8m)	16 oz.	0.02"	Red
36149	Roll	5' (1.5m)	150' (45.8m)	16 oz.	0.02"	Red
36150	Roll	6' (1.8m)	150' (45.8m)	23 oz.	0.034"	Yellow
36151	Roll	5' (1.5m)	150' (45.8m)	23 oz.	0.034"	Yellow
36162	Blanket	10' (3.0m)	10' (3.0m)	23 oz.	0.034"	Yellow
36163	Blanket	8' (2.4m)	10' (3.0m)	23 oz.	0.034"	Yellow
36171	Blanket	3.3' (1.0m)	150' (45.8m)	23 oz.	0.034"	Yellow
36293	Blanket	6' (1.8m)	6' (1.8m)	23 oz.	0.034"	Yellow
36308	Blanket	6' (1.8m)	8' (2.4m)	23 oz.	0.034"	Yellow
37192	Blanket	10' (3.0m)	10' (3.0m)	15 oz.	0.02"	Gray
37609	Blanket	8' (2.4m)	8' (2.4m)	23 oz.	0.034"	Yellow
Custom	Custom	Custom	Custom	23 oz.	0.034"	Yellow



Excellent abrasion and tear resistance

Grommets allow easy hanging in vertical applications

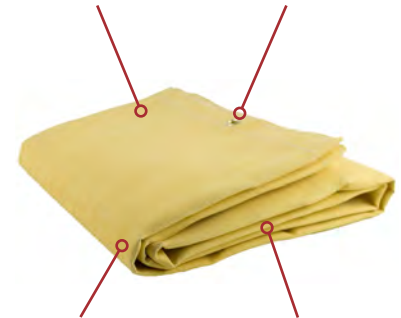

300°F working temperature

Provides protection from most welding sparks, spatter, and slag

Welding Blankets Uncoated Fiberglass

PRODUCT NO.	Product Type	Width	Length	Weight (per sq yd.)	Thickness	Color
36144	Roll	3.3' (1.0m)	150' (45.8m)	18 oz.	0.028"	White
36145	Roll	5' (1.5m)	150' (45.8m)	18 oz.	0.028"	White
36146	Roll	5' (1.5m)	150' (45.8m)	24 oz.	0.028"	White
36147	Roll	3.3' (1.0m)	150' (45.8m)	24 oz.	0.028"	White
36159	Blanket	6' (1.8m)	8' (2.4m)	24 oz.	0.028"	White
36160	Blanket	6' (1.8m)	6' (1.8m)	24 oz.	0.028"	White
36161	Blanket	8' (2.4m)	10' (3m)	18 oz.	0.028"	White
36167	Blanket	10' (3.0m)	10' (3m)	18 oz.	0.028"	White
36290	Blanket	6' (1.8m)	6' (1.8m)	18 oz.	0.028"	White
36305	Blanket	6' (1.8m)	8' (2.4m)	18 oz.	0.028"	White
36364	Blanket	8' (2.4m)	8' (2.4m)	18 oz.	0.028"	White
Custom	Custom	Custom	Custom	18 oz.	0.028"	White

Low irritating yarns prevents itch

Grommets allow easy hanging in vertical applications



1000°F working temperature

Ideal for welding, insulation, and jacketing applications

All high-temp fabrics are certified to meet ANSI/FM-4950

Custom Size Blankets Available



MEDIUM DUTY PROTECTION

Welding Blankets Silicone Coated Fiberglass



PRODUCT NO.	Product Type	Width	Length	Weight (per sq yd.)	Thickness	Color
36173	Roll	3.3' (1.0m)	150' (45.8m)	32 oz.	0.04"	Red
36174	Roll	5' (1.5m)	150' (45.8m)	32 oz.	0.04"	Red
36155	Blanket	6' (1.8m)	8' (2.4m)	32 oz.	0.04"	Red
36156	Blanket	6' (1.8m)	6' (1.8m)	32 oz.	0.04"	Red
37592	Blanket	10' (3.0m)	10' (3m)	32 oz.	0.04"	Red
Custom	Custom	Custom	Custom	32 oz.	0.04"	Red

Welding Blankets Vermiculite



PRODUCT NO.	Product Type	Width	Length	Weight (per sq yd.)	Thickness	Color
36152	Roll	6' (1.8m)	150' (45.8m)	24 oz.	0.03"	Black
36153	Roll	5' (1.5m)	150' (45.8m)	24 oz.	0.03"	Black
36154	Roll	3.3' (1.0m)	150' (45.8m)	24 oz.	0.03"	Black
36157	Blanket	8' (2.4m)	8' (2.4m)	24 oz.	0.03"	Black
36164	Blanket	10' (3.0m)	10' (3m)	24 oz.	0.03"	Black
36166	Blanket	8' (2.4m)	10' (3m)	24 oz.	0.03"	Black
36302	Blanket	6' (1.8m)	6' (1.8m)	24 oz.	0.03"	Black
36318	Blanket	6' (1.8m)	8' (2.4m)	24 oz.	0.03"	Black
Custom	Custom	Custom	Custom	24 oz.	0.03"	Black

HEAVY-DUTY PROTECTION



Welding Blankets Silica Cloth

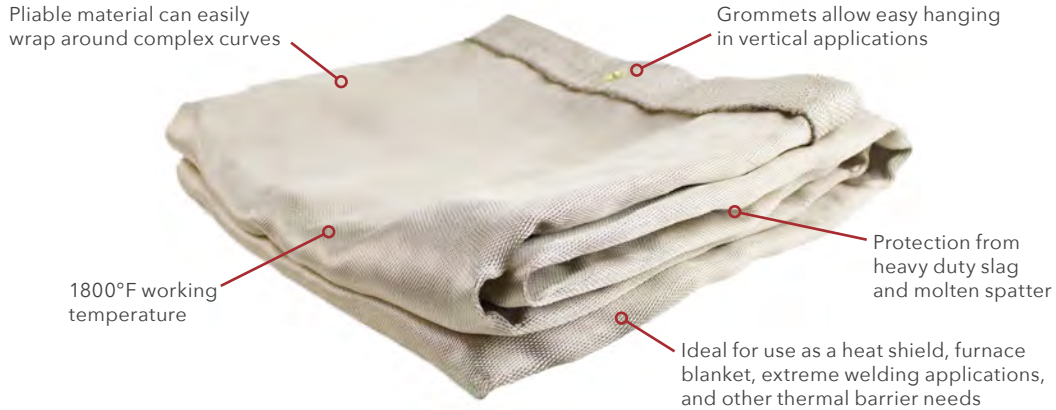

PRODUCT NO.	Product Type	Width	Length	Weight (per sq yd.)	Thickness	Color
36165	Roll	3' (.9m)	150' (45.8m)	18 oz.	0.04"	Tan
36291	Blanket	6' (1.8m)	6' (1.8m)	18 oz.	0.04"	Tan
36306	Blanket	6' (1.8m)	8' (2.4m)	18 oz.	0.04"	Tan
Custom	Custom	Custom	Custom	18 oz.	0.04"	Tan

Welding Blankets Carbon Fiber Felt



PRODUCT NO.	Product Type	Width	Length	Weight (per sq yd.)	Thickness	Color
36158	Roll	5' (1.5m)	75' (22.9m)	16 oz.	0.125"	Black
36208	Roll	6' (1.8m)	150' (45.8m)	16 oz.	0.125"	Black
36313	Blanket	6' (1.8m)	8' (2.4m)	16 oz.	0.125"	Black
36320	Blanket	6' (1.8m)	6' (1.8m)	16 oz.	0.125"	Black
Custom	Custom	Custom	Custom	16 oz.	0.125"	Black



WELDING ACCESSORIES

Double Layer Hand Pad

- Increases the life of your glove
- Allows longer welding time even in high heat applications
- Does not limit mobility
- Sewn and riveted for added durability
- Double layer protection

PRODUCT NO. Description

36680	Double Layer Hand Pad
--------------	-----------------------



CUSTOMIZATION PROGRAM



Wilson is pleased to offer a custom solutions program to fit your specific size and protection needs. We can work with an existing design or be involved in the entire process from start to finish. Each custom order is manufactured to your exact specifications and carefully inspected to ensure the highest quality.

- Orders processed within 24 hours
- Orders shipped within 5 business days
- Competitively priced no matter how complex the job
- Custom grommet placement available or choose without grommets
- Special fabrication program available on transparent welding curtains and blankets

To learn more about what welding curtain or blanket is best for you, contact us today at 800.323.7402. Special made-to-order curtains and blankets are our specialty!





PERSONAL PROTECTIVE EQUIPMENT

JACKSON
SAFETY

sellstrom

KneePro
ULTRA FLEX

 **duenorth**

K1
SERIES

TABLE OF CONTENTS

FACE PROTECTION	79-111
EYE PROTECTION — SAFETY GLASSES	112-127
EYE PROTECTION — GOGGLES	128-143
EMERGENCY EYEWASH PRODUCTS	144-146
HEARING PROTECTION	147-155
HEAD PROTECTION	156-173
RESPIRATORY PROTECTION	174-175
KNEE AND ELBOW PROTECTION	176-181
SLIP PROTECTION	182-196



JACKSON[®]
SAFETY

sellstrom[®]

FACE PROTECTION

SHIELDING YOU FROM THE ELEMENTS

Please note: Always wear safety glasses when using face shields.

JACKSON
SAFETY

EXCLUSIVE!

Optional Shade 5 and 8 flip-up visors deliver unmatched versatility and uninterrupted protection

Extra-large anti-fog window provides superior panoramic view



Extra-large crown provides added top of head protection

370
SPEED DIAL

370 Speed Dial™ headgear achieves maximum comfort and fit

Integrated side and chin guard for maximum protection against splash and flying debris

Hard Hat Interchange system available



QUAD™ 500 FACE SHIELDS — SUPREME MULTI-PURPOSE

NEW!

Quad™ 500 Multi-Purpose Face Shield System

- Jackson Safety® introduces the all new Quad 500 multi-purpose face shield, our premium face protection product
- The Quad 500 offers an unparalleled range of face and eye protection solutions for almost every application including grinding, cutting, oxy/acetylene cutting, plasma cutting, and brazing
- All Quad 500 products have been designed to offer maximum above-the-neck face protection, including an extra-large molded polycarbonate window featuring our premium Sta-Clear® anti-fog coating
- For added protection, the molded window is completely framed on the sides and chin and features an extra-large crown
- The Quad 500 offers exceptional panoramic views with virtually no distortion

Featuring the exclusive Jackson Safety® 370 Speed Dial™ ratcheting headgear system!

- The Quad 500 features the Jackson Safety® 370 Speed Dial™ ratcheting headgear system — an industry best!
- The 370 Speed Dial™ is highlighted by Jackson's famous "Easy Grab-Easy Turn" oversized adjusting dial and patented swivel adjuster band, achieving maximum comfort and fit quickly, easily, and conveniently — saves time, increases productivity, and improves worker safety!



Available with optional flip-up/flip-down extra-large IR window

- The Quad 500 face shield is also available with an exclusive, extra-large flip-up/flip-down IR window for added eye protection when used in applications producing infrared hazards
- It's easy and safe — by keeping the Quad 500 clear window in the down position at all times, the operator can flip the IR shaded window up or down, providing uninterrupted face protection during cutting and grinding operations
- Flip windows available in:
 - **Shade 5 IR** for oxy/acetylene cutting, brazing, and plasma cutting
 - **Shade 8 IR** for oxy/acetylene welding and plasma cutting
- Both the clear and flip windows feature detents that lock in both the up and down positions
- Designed to be used with most goggles, respirators, and all safety glasses
- Two available mounting options:
 - Complete with Jackson Safety's premium 370 Speed Dial™ ratcheting headgear suspension
 - For mounting on slotted hard hats, assembled with Jackson Safety's exclusive HHIS slot adaptors
- All models meet or exceed **ANSI Z87.1+ high impact** standards
- Models 14220, 14230, 14233, 14235 **CSA certified to CAN/CSA Z94.3** standards
- Models 14220, 14230, 14233 **CE certified**



14230

FACE SHIELDS – SUPREME MULTI-PURPOSE

Quad™ 500 Series – Crown, Window, and 370 Speed Dial™ Ratcheting Headgear

- Face shield comes with:
 - Stylish crown and wraparound face shield frame
 - Premium molded polycarbonate AF window
 - 370 Speed Dial™ premium ratcheting headgear suspension



PRODUCT NO.	Crown	Suspension	Window	Coatings	Chin & Side Guard	Case Qty.
14220	Black	Ratcheting	Clear	Anti-fog	Yes	4



14220

Quad™ 500 Series – Crown, Window, and HHIS Universal Hard Hat Slot Adaptor

- Face shield comes with:
 - Stylish crown and wraparound face shield frame
 - Premium molded polycarbonate AF window
 - Exclusive Jackson Safety® HHIS universal slot hard hat adaptor
 - Fits most slotted hard hats



PRODUCT NO.	Crown	Suspension	Window	Coatings	Chin & Side Guard	Case Qty.
14225	Black	Universal Adaptor	Clear	Anti-Fog	Yes	4



14225

Quad™ 500 Series – c/w Flip-Up IR Window and 370 Speed Dial™ Ratcheting Headgear

- Multi-purpose face shield comes with:
 - Stylish crown and wraparound face shield frame
 - Premium molded polycarbonate AF window
 - Extra-large flip-up/flip-down IR visor
 - 370 Speed Dial™ premium ratcheting headgear suspension



PRODUCT NO.	Crown	Suspension	Window	Coatings	Flip Visor	Chin & Side Guard	Case Qty.
14230	Black	Ratcheting	Clear	Anti-Fog	Shade 5 IR	Yes	4
14233	Black	Ratcheting	Clear	Anti-Fog	Shade 8 IR	Yes	4



14230/14233

Quad™ 500 Series – c/w Flip-Up IR Window and HHIS Universal Hard Hat Slot Adaptor

- Multi-purpose face shield comes with:
 - Stylish crown and wraparound face shield frame
 - Premium molded polycarbonate AF window
 - Extra-large flip-up/flip-down IR visor
 - Exclusive Jackson Safety® HHIS universal slot hard hat adaptor
 - Fits most slotted hard hats



PRODUCT NO.	Crown	Suspension	Window	Coatings	Flip Visor	Chin & Side Guard	Case Qty.
14235	Black	Universal Adaptor	Clear	Anti-Fog	Shade 5 IR	Yes	4
14238	Black	Universal Adaptor	Clear	Anti-Fog	Shade 8 IR	Yes	4



14235 /14238

Quad™ 500 Series Replacement Windows & Parts

PRODUCT NO.	Description	Fits Models	Case Qty.
14250	8.58" x 8.24" x .060" Clear Anti-Fog Window	All Quad 500 Models	12
14255	4.375" x 9.25" x .070" Shade 5 IR Visor	All Quad 500 Models	12
14258	4.375" x 9.25" x .070" Shade 8 IR Visor	All Quad 500 Models	12
20694	370 Face Shield Headgear	14220, 14230, 14233	12
32187	Replacement Washable Sweatband – 2/pack	14220, 14230, 14233	24 packs
38423	HHIS Face Shield Hard Hat Adaptor	14225, 14235, 14238	12

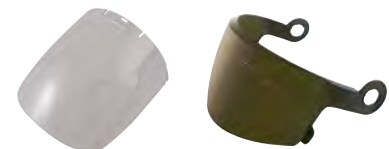

14250

14255/14258

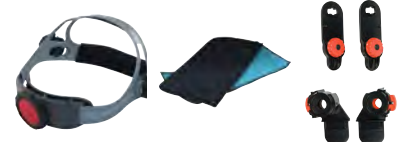

20694

32187

38423

sellstrom[®]

EXCLUSIVE!



Please note: Always wear safety glasses when using face shields.

DP4 FACE SHIELDS — PREMIUM MULTI-PURPOSE



S32010

DP4 Multi-Purpose Face Shield System

- Sellstrom's exclusive multi-purpose DP4 face shield system has been an industry leader for more than 15 years
- The DP4 offers an incredible range of face protection solutions

DP4 Face Shield Only

- As a standard face shield, the DP4's specially designed molded polycarbonate window curves naturally to fit facial contours
- Offers exceptional panoramic views with virtually no distortion
- Window meets high-impact standards and is chemical resistant
- Available in three full-sized window options: clear anti-fog (S32010), Shade 3 IR (S32030) or Shade 5 IR (S32050)
- Standard DP4 face shields feature a premium ratcheting headgear for maximum operator comfort and convenience
- Model S32261 **CSA certified**

FACE SHIELDS – PREMIUM MULTI-PURPOSE

DP4 Face Shield with Flip-Up/Flip-Down IR Windows

- The DP4 face shield is also available featuring a unique spring-mounted flip-up/flip-down IR window (4.375" x 9.25" x .070")
- It's easy and safe — by keeping the full size DP4 clear window in the down position at all times, the operator can flip the spring-mounted IR Shaded window up or down, providing uninterrupted face protection during cutting and grinding operations
- Flip visor available in:
 - **Shade 5** IR for: oxy/acetylene cutting, brazing and plasma cutting
 - **Shade 6** IR for: oxy/acetylene cutting, brazing and plasma cutting
 - **Shade 8** IR for: oxy/acetylene welding and plasma cutting
 - **Shade 6B Cobalt Blue** for: oxy/acetylene welding of aluminum and cast iron, in metal and glass furnace foundry work
 - Cobalt Blue diffuses the orange glow associated with the sodium in molten metal and glass
- DP4 multi-purpose face shields are available in two mounting options: premium ratcheting headgear suspension or exclusive universal slot adaptors (for mounting on slotted hard hats)

DP4 Face Shields Now Available With Optional Chin Guard

- All DP4 face shields can be fitted with optional chin guard (S32200) for added below-the-neck protection during cutting and grinding operations
- DP4 Face shields can be ordered with the chin guard included, or if you already own a DP4 face shield, the chin guard can be ordered separately and easily attached by the operator

DP4 Safety Standards

- All models meet or exceed **ANSI Z87.1+ high impact** standards
- Models S32010, S32151, S32181, S32251, S32281 **CSA certified to CAN/CSA Z94.3** standards
- Model S32010 **CE certified**

sellstrom®



S32151



S32251



sellstrom®



S32010



S32210



S32012



S32151



S32251

FACE SHIELDS – PREMIUM MULTI-PURPOSE

DP4 Series – Crown, Window, and Ratcheting Headgear Only

Face shield comes with:

- Stylish crown
- Full 9" x 12.125" x .060" molded polycarbonate AF window
- Premium ratcheting headgear suspension (S32011)
- Model S32210 is **CSA certified**

PRODUCT NO.	Crown	Suspension	Window	Coatings	Chin Guard	Case Qty.
S32010	Black	Ratcheting	Clear	Anti-Fog	No	4
S32030	Black	Ratcheting	Shade 3 IR	Uncoated	No	4
S32050	Black	Ratcheting	Shade 5 IR	Uncoated	No	4
S32210	Black	Ratcheting	Clear	Anti-Fog	Yes	4

DP4 Series – Crown, Window, and Universal Hard Hat Slot Adaptor Only

Face shield comes with:

- Stylish crown
- Full 9" x 12.125" x .060" molded polycarbonate AF window
- Features Sellstrom's exclusive universal slot adaptors (S61970)
- Fits most slotted hard hats



S61970

PRODUCT NO.	Crown	Suspension	Window	Coatings	Chin Guard	Case Qty.
S32012	Black	Universal Adaptor	Clear	Anti-Fog	No	4
S32032	Black	Universal Adaptor	Shade 3 IR	Uncoated	No	4
S32052	Black	Universal Adaptor	Shade 5 IR	Uncoated	No	4
S32212	Black	Universal Adaptor	Clear	Anti-Fog	Yes	4

DP4 Series – c/w Flip-Up IR Window, and Ratcheting Headgear

Multi-purpose face shields come with:

- Stylish crown
- Full 9" x 12.125" x .060" molded polycarbonate AF window
- 4.375" x 9.25" x .070" flip-up/flip-down IR visor
- Premium ratcheting headgear suspension (S32011)

PRODUCT NO.	Crown	Suspension	Window	Coatings	Flip Visor	Chin Guard	Case Qty.
S32151	Black	Ratcheting	Clear	Anti-Fog	Shade 5 IR	No	4
S32161	Black	Ratcheting	Clear	Anti-Fog	Shade 6 IR	No	4
S32161B	Black	Ratcheting	Clear	Anti-Fog	Shade 6 Cobalt	No	4
S32181	Black	Ratcheting	Clear	Anti-Fog	Shade 8 IR	No	4
S32251	Black	Ratcheting	Clear	Anti-Fog	Shade 5 IR	Yes	4
S32261	Black	Ratcheting	Clear	Anti-Fog	Shade 6 IR	Yes	4
S32281	Black	Ratcheting	Clear	Anti-Fog	Shade 8 IR	Yes	4

FACE SHIELDS – PREMIUM MULTI-PURPOSE

DP4 Series – c/w Flip-Up IR Window, and Universal Hard Hat Slot Adaptor

Multi-purpose face shields come with:

- Stylish crown
- Full 9" x 12.125" x .060" molded polycarbonate AF window
- 4.375" x 9.25" x .070" flip-up/flip-down IR visor
- Features Sellstrom's exclusive universal slot adaptors (S61970)
- Fits most slotted hard hats



S61970

PRODUCT NO.	Crown	Suspension	Window	Coatings	Flip Visor	Chin Guard	Case Qty.
S32152	Black	Universal Adaptor	Clear	Anti-Fog	Shade 5 IR	No	4
S32162	Black	Universal Adaptor	Clear	Anti-Fog	Shade 6 IR	No	4
S32162B	Black	Universal Adaptor	Clear	Anti-Fog	Shade 6 Cobalt	No	4
S32182	Black	Universal Adaptor	Clear	Anti-Fog	Shade 8 IR	No	4
S32252	Black	Universal Adaptor	Clear	Anti-Fog	Shade 5 IR	Yes	4
S32262	Black	Universal Adaptor	Clear	Anti-Fog	Shade 6 IR	Yes	4
S32282	Black	Universal Adaptor	Clear	Anti-Fog	Shade 8 IR	Yes	4

DP4 Series Replacement Windows, and Parts

PRODUCT NO.	Description	Fits Models	Case Qty.
S32000	Black Crown (only) for Standard Face Shields	All Standard Face Shields	12
S32001	Black Crown (only) for Flip Front Visor Models	All Flip-Up Face Shields	10
S32003	Black Crown with Universal Slot Adaptor for all USA Flip-Up Face Shields Flip-Up Visor Models	All USA Flip-Up Face Shields	30
S32011	Replacement Ratcheting Headgear	S32010, S32030, S32050, S32151, S32161, S32161B, S32181, S32210, S32251, S32261, S32281	10
S32100	9" x 12.125" x .060" Clear Anti-Fog Window	All DP4 Models	120
S32130	9" x 12.125" x .060" Shade 3 IR Window	S32030	120
S32150	9" x 12.125" x .060" Shade 5 IR Window	S32050	120
S32155	4.375" x 9.25" x .070" Shade 5 IR Visor	S32151, S32152, S32153, S32251, S32252	120
S32166	4.375" x 9.25" x .070" Shade 6 IR Visor	S32161, S32162, S32163, S32261, S32262	120
S32166B	4.375" x 9.25" x .070" Shade 6 Cobalt Blue Visor	S32161B, S32162B, S32163B	120
S32188	4.375" x 9.25" x .070" Shade 8 IR Visor	S32181, S32182, S32183, S32281, S32282	120
S32200	Optional Chin Guard only	All DP4 Models	20



S32050



S32052



Sellstrom Universal Slot Adapter fits most slotted hard hats.



S32152



S32252



S32000



S32003



S32011



S32155



S32200

JACKSON
SAFETY

EXCLUSIVE!



Extended top-of-head coverage protects against hazards from above

Lightweight and balanced construction for all-day comfort

Extra-large polycarbonate window for superior optics and industry-leading panoramic views

Up and down detents lock securely in place until manually adjusted

Available with premium Sta-Clear® anti-fog coating

Built-in side and chin guard protects against splash and flying debris

370
SPEED DIAL

370 Speed Dial™ headgear achieves maximum comfort and fit

MAXVIEW™ FACE SHIELDS — PREMIUM

NEW!

Maxview™ Face Shield System

- Jackson Safety® introduces the all new Maxview face shield, a premium face protection product
- The Maxview is designed to offer maximum face protection coverage, incorporating an extra-large clear polycarbonate window that is available in two options: without anti-fog treatment or with our premium Sta-Clear® anti-fog coating
- The high-impact PC window is then framed on the side and chin areas and features an extra-large crown
- This combination translates into maximum coverage, head to lower neck, and side to side. In fact, Maxview offers a full 1" of extra window protection on each side (2" total) versus the leading face shield model, ensuring best-in-class protection and exceptional panoramic views. Check and compare!
- Given its amazing coverage and viewing area, the Maxview is incredibly light
- Maxview incorporates engineered detents that lock in both the up and down positions
- Designed to be used with most goggles, respirators, and all safety glasses
- Two available mounting options:
 - Complete with Jackson Safety's premium 370 Speed Dial™ ratcheting headgear suspension
 - For mounting on slotted hard hats, assembled with Jackson Safety's exclusive HHIS slot adaptors

Featuring the exclusive Jackson Safety® 370 Speed Dial™ ratcheting headgear system!

- The Maxview face shield features the Jackson Safety® 370 Speed Dial™ ratcheting headgear system — an industry best!
- The 370 Speed Dial™ is highlighted by Jackson's famous "Easy Grab-Easy Turn" oversized adjusting dial and patented swivel adjuster band, achieving maximum comfort and fit quickly, easily, and conveniently — saves time, increases productivity, and improves worker safety!

370
SPEED DIAL

- All models meet or exceed ANSI Z87.1+ high impact standards
- Models 14200, 14201 CSA certified to CAN/CSA Z94.3 standards
- Models 14200, 14201 CE certified

Hard Hat
Interchange
system available



FACE SHIELDS – PREMIUM

Maxview™ Series – Crown, Window, and 370 Speed Dial™ Ratcheting Headgear

- Face shield comes with:
 - Extra-large stylish crown and wraparound face shield frame
 - High-impact polycarbonate window (with or without anti-fog)
 - 370 Speed Dial™ premium ratcheting headgear suspension



PRODUCT NO.	Crown	Suspension	Window	Coatings	Chin & Side Guard	Case Qty.
14200	Black	Ratcheting	Clear	None	Yes	4
14201	Black	Ratcheting	Clear	Anti-Fog	Yes	4



14200/14201

Maxview™ Series – Crown, Window, and HHIS Universal Hard Hat Slot Adaptor

- Face shield comes with:
 - Extra-large stylish crown and wraparound face shield frame
 - High-impact polycarbonate window (with or without anti-fog)
 - Exclusive Jackson Safety® HHIS universal slot hard hat adaptor
 - Fits most slotted hard hats



PRODUCT NO.	Crown	Suspension	Window	Coatings	Chin & Side Guard	Case Qty.
14202	Black	Universal Adaptor	Clear	None	Yes	4
14203	Black	Universal Adaptor	Clear	Anti-Fog	Yes	4



14202/14203

Maxview™ Series Replacement Windows & Parts

PRODUCT NO.	Description	Fits Models	Case Qty.
14214	Clear replacement window	All Maxview Models	36
14215	Clear replacement window – Anti-fog	All Maxview Models	36
20695	370 Speed Dial replacement headgear	14200, 14201	12
32187	Replacement Washable Sweatband – 2/pack	14200, 14201	24 packs
38424	HHIS Face Shield Hard Hat Adaptor	14202, 14203	6



14214, 14215



38424



20695



32187

A JACKSON EXCLUSIVE!





Please note: Always wear safety glasses when using face shields.

AN
AMERICAN
LEGEND!



S38110

380 FACE SHIELDS — PREMIUM DUAL CROWN

MADE IN
USA

380 Series Face Shields

- Sellstrom's 380 Series "Dual Crown" face shields have been the industry standard for decades
- **Made in the USA**, these premium face shields are manufactured using superior, extra wide polycarbonate windows
- Anti-fog models are treated using an exclusive Sta-Clear® chemical solution that is superior to other anti-fog treatments
- These face shields are virtually 100% fog free
- The 380 Series "crown and chin" combination offers an exclusive extra-wide side window, as well as oversized crown and chin guards
- You can't buy better protection from splashes, flying particles, and debris
- Complete units feature premium 6.5" x 19.5" x .040" clear, Sta-Clear® anti-fog, Shade 5 IR, and dark green tinted windows
- Windows attach using exclusive Sellstrom patterned pin mount design
- Available with exclusive Sellstrom designed Ratchet Headgear suspension (S27051) or Universal Slotted Hard Hat Adapter (S61970)
- All models meet or exceed **ANSI Z87.1+ high impact** standards
- Models S38110, S38140, S38150 **CSA certified to CAN/CSA Z94.3** standards
- Models S38110, S38140, S38150, S38410, S38440 **CE certified**

Impact resistant polycarbonate windows available in clear, anti-fog, and Shade 5 IR

Max Light model features clear crown and chin protector option for increased clarity and visibility

MADE IN USA

Premium ratcheting headgear

Oversized crown and chin guards and extra-wide side window provides superior face, neck and side protection

A Sellstrom exclusive

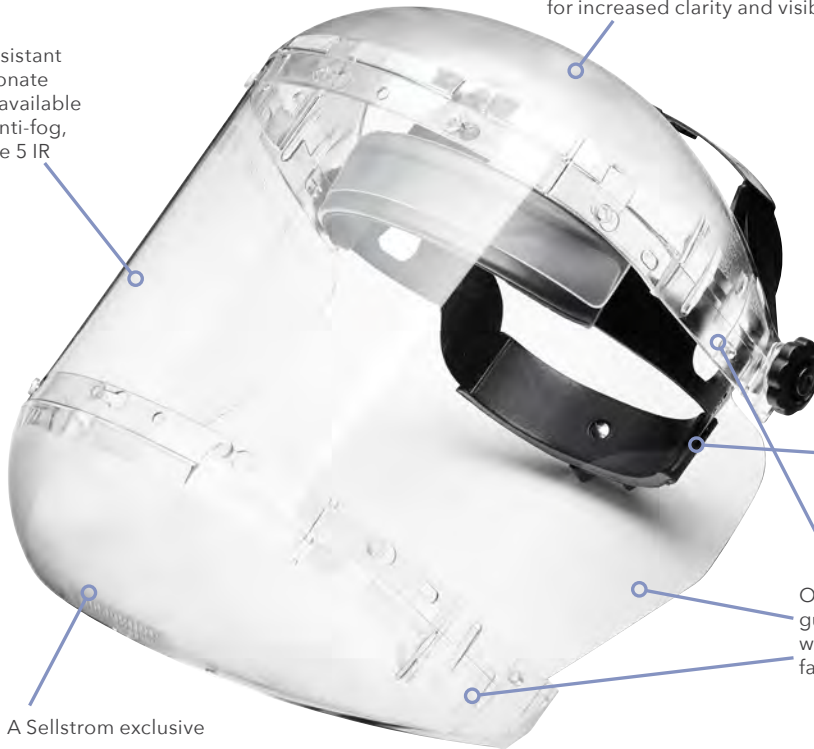

S38410

380 Series – Dual Crown, Window, and Ratcheting Headgear

Face shield comes with:

- Extra-large high impact blue crown and chin protector
- Premium polycarbonate extra-wide scratch-resistant windows
- Premium ratcheting headgear suspension (S27051)

PRODUCT NO.	Crown	Chin	Suspension	Tint	Coatings	Case Qty.
S38110	Blue	Blue	Ratcheting	Clear	Uncoated	4
S38140*	Blue	Blue	Ratcheting	Clear	Sta-Clear® Anti-Fog	4
S38150	Blue	Blue	Ratcheting	Shade 5 IR	Uncoated	4



S38110

380 Series "MAX LIGHT" – Dual Crown, Window, and Ratcheting Headgear

Face shield comes with:

- Extra-large high impact clear crown and chin protector
- Premium polycarbonate extra-wide scratch resistant windows
- Premium ratcheting headgear suspension (S27051)

PRODUCT NO.	Crown	Chin	Suspension	Tint	Coatings	Case Qty.
S38410	Clear	Clear	Ratcheting	Clear	Uncoated	4
S38440*	Clear	Clear	Ratcheting	Clear	Sta-Clear® Anti-Fog	4



S38440

*Please note: Anti-fog windows use an acetate window instead of a polycarbonate window.

sellstrom®



S38210



S38540



S36000



S36050



S27051

FACE SHIELDS – PREMIUM DUAL CROWN

**MADE IN
USA**

380 Series – Dual Crown, Window, and Universal Hard Hat Slot Adaptor

Face shield comes with:

- Extra-large high impact blue crown and chin protector
- Premium polycarbonate extra-wide scratch resistant windows
- Exclusive universal hard hat slot adaptor (S61970)
- Fits most slotted hard hats



S61970

PRODUCT NO.	Crown	Chin	Suspension	Tint	Coatings	Case Qty.
S38210	Blue	Blue	Universal Adaptor	Clear	Uncoated	4
S38230	Blue	Blue	Universal Adaptor	Dark Green†	Uncoated	4
S38240*	Blue	Blue	Universal Adaptor	Clear	Sta-Clear® Anti-Fog	4
S38250	Blue	Blue	Universal Adaptor	Shade 5 IR	Uncoated	4

†Not for use as IR protection

380 Series “MAX LIGHT” – Dual Crown, Window, and Universal Hard Hat Slot Adaptor

Face shields come with:

- Extra-large high impact clear crown and chin protector
- Premium acetate extra-wide scratch resistant windows
- Exclusive universal hard hat slot adaptor (S61970)
- Fits most slotted hard hats



S61970

PRODUCT NO.	Crown	Chin	Suspension	Tint	Coatings	Case Qty.
S38510	Clear	Clear	Universal Adaptor	Clear	Uncoated	4
S38540*	Clear	Clear	Universal Adaptor	Clear	Sta-Clear® Anti-Fog	4

380 Series Replacement Windows

- Sellstrom carries a wide range of replacement acetate windows
- Available in clear, Sta-Clear™ Anti-Fog, Shade 5 IR, and dark green
- All windows listed below fit the Sellstrom 380 Series dual crown platform
- Windows attachment pattern exclusive to Sellstrom's 380 Series crown

PRODUCT NO.	Window Dimensions	Tint	Coatings	Case Qty.
S36000	6.5" x 19.5" x .040"	Clear	Uncoated	125
S36020	6.5" x 19.5" x .040"	Dark Green†	Uncoated	125
S36040*	6.5" x 19.5" x .040"	Clear	Sta-Clear™ Anti-Fog	125
S36050	6.5" x 19.5" x .040"	Shade 5 IR	Uncoated	100

†Not for use as IR protection

Please note: For replacement ratcheting headgear, use #S27051.

*Anti-fog windows use an acetate window instead of a polycarbonate window.

MADE IN
USA

Single crown style is lightweight and allows for increased air circulation

Impact resistant polycarbonate windows available in clear, anti-fog, and Shade 5 IR

Meets ANSI Z87.1+ high-impact standards and CUL certified to meet CAN/CSA Z94.3 standards

Patterned pin mount design allows for quick and simple window replacement – requires no tools

Available with adjustable ratchet headgear suspension for a custom fit at the turn of the knob

390 FACE SHIELDS – PREMIUM SINGLE CROWN

390 Series Face Shields

- Sellstrom’s 390 Series face shields have been the industry standard for decades
- **Made in the USA**, these premium face shields are manufactured using superior polycarbonate windows
- Anti-fog models are treated using an exclusive Sta-Clear® chemical solution that is superior to other anti-fog treatments
- These face shields are virtually 100% fog free
- The shield curves naturally to fit facial contours — excellent protection from splash, chemical splash, particles and flying debris
- Extra-large high impact crown provides excellent above-the-head coverage
- Complete units available with standard 8" x 12" x .040" clear, Sta-Clear® Anti-Fog, and Shade 5 IR windows
- Extra-large 8" x 16" x .040" windows are also available (optional)
- Windows attach using exclusive Sellstrom patterned pin mount design
- Headgear models available with pinlock or Sellstrom’s exclusive ratcheting headgear suspensions (S27051)
- All models meet or exceed **ANSI Z87.1+ high impact** standards
- Models S39110, S39140, and S39150 **CSA certified to CAN/CSA Z94.3** standards



S39110

sellstrom®



S39010
(Pinlock)



S39110



S39150



S39210



S39250

FACE SHIELDS – PREMIUM SINGLE CROWN

**MADE IN
USA**

390 Series – Single Crown, Window, and Pinlock Headgear

Face shield comes with:

- Extra-large high impact blue crown
- Premium polycarbonate scratch-resistant windows (two sizes available)
- Pinlock headgear suspension

PRODUCT NO.	Crown	Suspension	Window Dimensions	Tint	Coatings	Case Qty.
S39010	Blue	Pinlock	8" x 12" x .040"	Clear	Uncoated	12
S39020	Blue	Pinlock	8" x 16" x .040"	Clear	Uncoated	12
S39040*	Blue	Pinlock	8" x 12" x .040"	Clear	Sta-Clear® Anti-Fog	12
S39050	Blue	Pinlock	8" x 12" x .060"	Shade 5 IR	Uncoated	12

390 Series – Single Crown, Window, and Ratcheting Headgear

Face shield comes with:

- Extra-large high impact blue crown
- Premium polycarbonate scratch resistant windows (two sizes available)
- Premium ratcheting headgear suspension (S27051)
- Model S39150 is **CSA certified**

PRODUCT NO.	Crown	Suspension	Window Dimensions	Tint	Coatings	Case Qty.
S39110	Blue	Ratcheting	8" x 12" x .040"	Clear	Uncoated	12
S39120	Blue	Ratcheting	8" x 16" x .040"	Clear	Uncoated	12
S39140*	Blue	Ratcheting	8" x 12" x .040"	Clear	Sta-Clear® Anti-Fog	12
S39150	Blue	Ratcheting	8" x 12" x .060"	Shade 5 IR	Uncoated	12

390 Series – Single Crown, Window, and Universal Hard Hat Slot Adaptor

Face shield comes with:

- Extra-large high impact blue crown
- Premium polycarbonate scratch resistant windows
- Exclusive universal hard hat slot adaptor (S61970)
- Fits most slotted hard hats



S61970

PRODUCT NO.	Crown	Suspension	Window Dimensions	Tint	Coatings	Case Qty.
S39210	Blue	Universal Adaptor	8" x 12" x .040"	Clear	Uncoated	24
S39240*	Blue	Universal Adapter	8" x 12" x .040"	Clear	Sta-Clear® Anti-Fog	24
S39250	Blue	Universal Adaptor	8" x 12" x .060"	Shade 5 IR	Uncoated	24

*Please note: Anti-fog windows use an acetate window instead of a polycarbonate window.

FACE SHIELDS – PREMIUM SINGLE CROWN



390 Series – Single Crown and Headgear Only (No Window)

Comes with:

- Extra-large high impact blue crown
- Headgear suspension of your choice
- Windows ordered separately (see window assortment below)

PRODUCT NO.	Crown	Suspension	Case Qty.
S39000	Blue	Pinlock Headgear	20
S39100	Blue	Ratcheting Headgear	20
S39200	Blue	Universal Hard Hat Slot Adaptor (S61970 for Slotted Hard Hats)	50



S39000 (Pinlock)



S39100



S39200

390 Series Replacement Windows

- Sellstrom carries a wide range of replacement/optional premium polycarbonate windows
- Available in clear, Sta-Clear™ Anti-Fog, Shade 5 IR, and dark green
- All windows listed below can be fitted to the Sellstrom 390 Series crown
- Window attachment pattern exclusive to Sellstrom's 390 Series crown

PRODUCT NO.	Window Dimensions	Tint	Coatings	Case Qty.
S35000	8" x 12" x .040"	Clear	Uncoated	250
S35020	8" x 12" x .040"	Dark Green*	Uncoated	250
S35040	8" x 12" x .040"	Clear	Sta-Clear® Anti-Fog	250
S35050	8" x 12" x .060"	Shade 5 IR	Uncoated	200
S35100	8" x 16" x .040"	Clear	Uncoated	200
S35120	8" x 16" x .040"	Dark Green*	Uncoated	120
S35140	8" x 16" x .040"	Clear	Sta-Clear® Anti-Fog	200
S35150	8" x 16" x .040"	Shade 5 IR	Uncoated	120



S35000



S35050

*Not for use as IR protection

FACE SHIELDS – REPLACEMENT PARTS

Replacement Headgear

- Sellstrom designed ratcheting headgear allows quick and easy, positive lock adjustability and great operator comfort

PRODUCT NO.	Description	Fits Series	Package Qty.
S27051	Replacement Ratcheting Headgear	311, 380, 390	10/Box



S27051



S31200

312 FACE SHIELDS – PREMIUM ARC-FLASH RATED

312 Series Arc Flash Rated Face Shields

ARCFLASH™

- Sellstrom Arc Flash-rated face shields provide protection from low level arc flash hazards
- Arc flash is created by an electric arc and can result in an explosive condition releasing electromagnetic energy, fragments and molten metals that can cause serious injury
- Sellstrom Arc Flash face shields feature a unique, molded high-impact and splash resistant polycarbonate window
- Provides optimum clarity with no distortion and panoramic vision
- Specially formulated window incorporates a light green tinted window that allows 55% light transmittance and true color optics
- These true color optics allow the operator to see all colors perfectly. This is critical when working around color coded wiring in electrical applications
- Two window versions: 9.9 Cal/cm² and 12 Cal/cm² ATPV rating
- Face shield curves naturally to fit facial contours, providing superior protection
- Available with or without hard hat, with a dielectric hard hat adaptor

312 Standards

- All product meets **ANSI Z87.1+ high-impact** standards, tested and certified to **ASTM F-2178** specifications and **NFPA 70E-2009** standards

FACE SHIELDS – PREMIUM ARC-FLASH RATED

312 Series – Dual Crown, Window, and Ratcheting Headgear

This model comes with:

- Premium ratcheting headgear suspension (S32011)
- Black high-impact crown and chin protector
- 9.9 Cal/cm² molded polycarbonate window

PRODUCT NO.	Crown	Chin	Suspension	Window Dimensions	Treatment	Case Qty.
S31200	Black	Black	Ratcheting	8" x 15" x .060"	Uncoated	4

312 Series – Dual Crown, Window, and Universal Hard Hat Slot Adaptor

This model comes with:

- Black high-impact crown and chin protector
- Universal slotted dielectric hard hat adaptor (S61970)
- 9.9 Cal/cm² molded polycarbonate window



S61970

PRODUCT NO.	Crown	Chin	Suspension	Window Dimensions	Treatment	Case Qty.
S31201	Black	Black	Universal Adaptor	8" x 15" x .060"	Uncoated	4

312 Series – Window, Adapter Bracket & Hard Hat Combination

This model comes with:

- Sellstrom six-point suspension white hard hat (S69500)
- Dielectric face shield bracket with slot adaptors (S61610)
- 12 Cal/cm² molded polycarbonate window

PRODUCT NO.	Helmet	Visor	Window Dimensions	Treatment	Case Qty.
S31223	White	Black	9.75" x 20" x .060"	Uncoated	4

312 Series – Window and Adapter Bracket with Hard Hat Slot Adaptors

This model comes with:

- Dielectric face shield bracket with hard hat slot adaptors (S61610)
- 12 Cal/cm² molded polycarbonate window

PRODUCT NO.	Visor	Suspension	Window Dimensions	Treatment	Case Qty.
S31224	Black	Universal Adaptor	9.75" x 20" x .060"	Uncoated	4

312 Series – Replacement Windows

PRODUCT NO.	Window Dimensions	ATPV Rating	Treatment	Fits Models	Case Qty.
S31220	8" x 15" x .060"	9.9 Cal/cm ²	Uncoated	S31200, 31201, 31202	30
S31222	9.75" x 20" x .060"	12 Cal/cm ²	Uncoated	S31223, 31224	30

sellstrom®



S31200



S31201



S31223



S31220

THE WORLD'S MOST COMPREHENSIVE UNIVERSAL MOUNT FACE SHIELD SYSTEM!

That's right! Jackson Safety® and Sellstrom®, two of the oldest safety brands in America, have joined forces to offer the most comprehensive universal mount face shield program anywhere! Whatever the job, we've got the perfect solution. Check out the next few pages and see for yourself. Our wide range of mounting options include four models of universal mount ratcheting headgear crowns, not the least of which is our new **F4XP**, featuring Jackson's world-famous **370 Speed Dial™** "comfort fit" headgear. The F4XP is simply the best, most comfortable face shield crown – period! From there, we offer over 15 models of universal mount hard hat face shield brackets, including Jackson's famous **Hard Hat Interchange System** face shield kit, and finally, our range of universal mount face shield windows includes the widest range of shapes, sizes and types under one roof. When you put it all together, there are hundreds of available options and solutions for you to choose from.

ALL PRODUCTS ON PAGES 96–109 INCORPORATE UNIVERSAL PIN PATTERN MOUNT SYSTEM

Universal Pin Mount Ratcheting Headgear Crowns							
							
	JACKSON F4XP	JACKSON 170-SB	JACKSON MODEL K	SELLSTROM S30100			
	BEST	BETTER	BETTER	GOOD			
Jackson Safety® Hard Hat Interchange System (for slotted hard hats)	 		 				
	JACKSON 39477 MASTER KIT		JACKSON 38425 FACE SHIELD KIT				
	BEST		BEST				
Universal Pin Mount Hard Hat Face Shield Brackets (Examples)							
	JACKSON 437	JACKSON 382-B	JACKSON 282-B	JACKSON 137	JACKSON 37	SELLSTROM S61900	SELLSTROM S61601
Universal Pin Mount Face Shield Windows							
	MOLDED					MOLDED	MOLDED
							
						MOLDED	
Available Materials: PETG, polycarbonate, acetate, propionate, IRUV, aluminum, copper, gold							

FACE SHIELDS – CROWNS, HEADGEAR, AND WINDOW KITS (UNIVERSAL MOUNTS)

301/303 Advantage Series



- Sellstrom offers a complete range of basic, economically priced face shields and windows under our Advantage Series program
- ABS injection molded crowns feature universal bracket pin pattern for use with universal mount windows
- Complete units available in single crown (301 Series) and dual crown (303 Series) versions with ratcheting headgear suspension
- Single crown units are available:
 - Complete with standard or aluminum bound windows and ratcheting headgear or;
 - Purchase the crown and headgear only and choose from a wide range of universal mount windows

Advantage Series Standards

- All models meet or exceed **ANSI Z87.1+ high impact** standards
- Models S30110, S30120, S30310 **CSA certified to CAN/CSA Z94.3** standards
- Models S30100, S30110, S30120 **CE certified**

301 Series – Single Crown and Ratcheting Headgear Only

- Gray ABS crown and comfortable ratcheting headgear
- Crown can be used to mount all Jackson and Sellstrom universal face shield windows as well as many other common brands found in the North American market
- Extremely versatile face shield mounting system

PRODUCT NO.	Crown	Suspension	Window Compatibility	Case Qty.
S30100	Gray	Ratcheting	Most Universal Face Shield Windows	30

301 Series – Single Crown, Window, and Ratcheting Headgear

- Gray ABS crown and comfortable ratcheting headgear suspension
- Crown can be used to mount all Jackson and Sellstrom universal face shield windows as well as many other common brands found in the North American market
- Comes complete with standard or aluminum bound 8" x 15.5" x .040" clear polycarbonate windows
- Extremely versatile face shield mounting system

PRODUCT NO.	Crown	Suspension	Window	Tint	Treatment	Case Qty.
S30110	Gray	Ratcheting	Aluminum Bound	Clear	Uncoated	25
S30120	Gray	Ratcheting	Standard	Clear	Uncoated	25

303 Series – Dual Crown, Window, and Ratcheting Headgear

- New to Sellstrom, this face shield offers both a crown and chin guard for added below-the-neck protection
- Comfortable ratcheting headgear suspension
- Window can be easily replaced (S37599)

PRODUCT NO.	Crown	Chin	Suspension	Window Tint	Treatment	Case Qty.
S30310	Gray	Gray	Ratcheting	Clear	Uncoated	16

sellstrom®



Universal pin mount window system
S30100



S30110



S30120



S30310



A JACKSON EXCLUSIVE!



14262 (kit)

F4XP

F4XP Premium Crown and 370 Speed Dial™ Ratcheting Headgear

- Jackson Safety® introduces the all new F4XP face shield crown and headgear, a premium face protection product
- The F4XP has been specially designed to offer maximum protection, ease of use, and extreme comfort and fit
- The oversized crown is manufactured using premium, high impact-rated materials for optimum safety
- Features an exclusive quick removal mounting system, ensuring fast and easy (universal) window changes
- The F4XP is designed to mount all universal pattern face shield windows including the full range of Jackson Safety® windows (F10, F20, F30, F40, and F50), making it one of the most advanced and versatile face shield programs in the world!
- Comes standard with a soft fabric replaceable front sweatband for improved comfort
- All models meet or exceed **ANSI Z87.1+ high impact** standards
- Models 14260 is **CSA certified to CAN/CSA Z94.3** standards when used in conjunction with windows 29087, 29080, 29106, and 30706
- Models 14260, 14262 **CE certified**

370
SPEED DIAL™

Featuring the Exclusive Jackson Safety® 370 Speed Dial™ Ratcheting Headgear System

- The F4XP crown features the Jackson Safety® **370 Speed Dial** ratcheting headgear system — an industry best!
- The **370 Speed Dial** is highlighted by Jackson's famous "Easy Grab-Easy Turn" oversized adjusting dial and patented swivel adjuster band, achieving maximum comfort and fit quickly, easily, and conveniently — saves time, increases productivity, and improves worker safety!

FACE SHIELDS – CROWNS, HEADGEARS, AND WINDOW KITS (UNIVERSAL MOUNTS)

BEST

JACKSON
SAFETY

F4XP Premium Crown, 370 Speed Dial Ratcheting Headgear and Window Kit

PRODUCT NO.	Crown	Suspension	Window	Mounting Pattern	Case Qty.
14260	Black	370 Speed Dial Ratcheting Headgear	None	Universal Bracket Pin Pattern	12
14262	Black	370 Speed Dial Ratcheting Headgear	Clear 8" x 15.5" x .060"	Universal Bracket Pin Pattern	12

F4XP Replacement Windows & Parts

PRODUCT NO.	Description	Fits Models	Case Qty.
20695	370 Speed Dial™ Ratcheting Headgear	14260	12
29087	8 x 15.5" x .060" Clear Molded Replacement Window	14260, 14262	12
32187	Replacement Washable Sweatband – 2/pack	14260, 14262	24 packs
38424	HHIS Face Shield Hard Hat Adaptor (option)	14260, 14262	6



14260 (Front)



14262 (kit)

F4XP Can be Used with Over 40 Jackson Windows

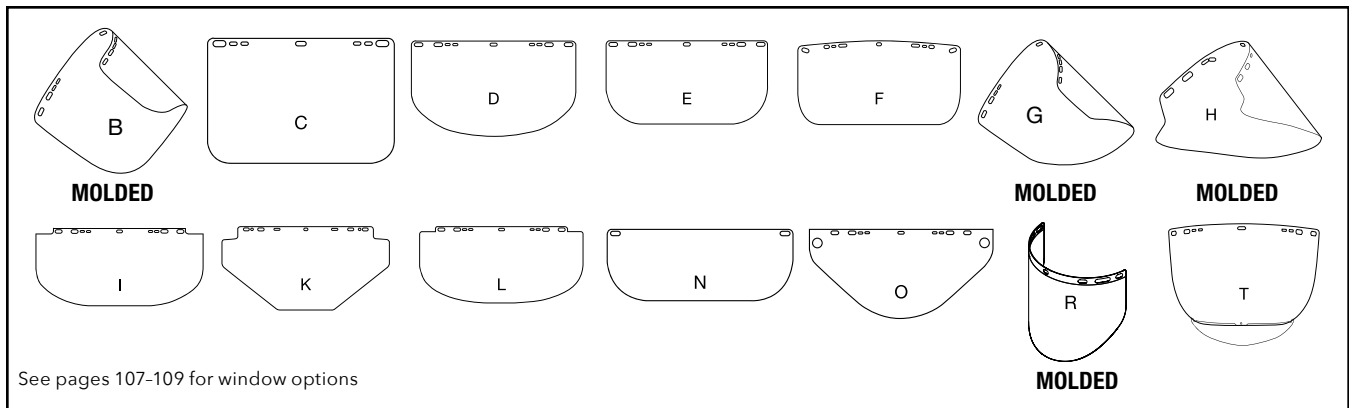

Oversized crown built with premium high impact rated material for maximum protection

For use with all universal pin pattern windows including over 30 Jackson models

Designed to offer maximum protection, ease-of-use, and extreme comfort and fit

(14262) F4XP Kit features premium 8" x 15.5" x .060" molded polycarbonate window (29087)

Exclusive quick-change install and removal system ensures fast and efficient window changes

NEW!

370
SPEED DIAL™

Speed Dial 370™ headgear offers the fastest, easiest, and most efficient ratcheting headgear system in the industry

Hard Hat Interchange system available



14262



14940/29077



14381/29051



29076

FACE SHIELDS – CROWNS, HEADGEARS, AND WINDOW KITS (UNIVERSAL MOUNTS)

170-SB – Single Crown and Ratcheting Headgear Only



- Our most popular legacy Jackson ratcheting crown and headgear!
- Features universal bracket pin pattern for use with universal mount windows
- Black injection molded crown and comfortable ratcheting headgear
- Large ratcheting adjuster knob is easy to find and use — even with gloves
- Replaceable sweatband included (#14958)
- Available in 12 pack or 40-piece bulk pack
- Meets **ANSI Z87.1+ high-impact** and **CAN/CSA Z94.3** standards

PRODUCT NO.	Old Code	Crown	Suspension	Mounting Pattern	Case Qty.
14940	3002436	Black	Ratcheting	Universal Bracket Pin Pattern	12
29077	3002447	Black	Ratcheting	Universal Bracket Pin Pattern	40 (bulk)

Model K – Single Crown and Ratcheting Headgear Only



- A long-standing Jackson ratcheting crown and headgear!
- Features universal bracket pin pattern for use with universal mount windows
- Black injection molded crown and comfortable ratcheting headgear
- Ratcheting adjuster knob is easy to find and use
- Replaceable sweatband included (#14958)
- Available in 12 pack or 60-piece bulk pack
- Meets **ANSI Z87.1+ high-impact** and **CAN/CSA Z94.3** standards

PRODUCT NO.	Old Code	Crown	Suspension	Mounting Pattern	Case Qty.
14381	3000001	Black	Ratcheting	Universal Bracket Pin Pattern	12
29051	3000006	Black	Ratcheting	Universal Bracket Pin Pattern	60 (bulk)

Model 131-B – Single Crown, Pinlock Headgear



- A basic crown and pinlock headgear designed for comfort, fit, and value
- Features universal bracket pin pattern for use with universal mount windows
- Easy-to-use pinlock adjuster mechanism — set it and forget it!
- Black injection molded crown
- Replaceable sweatband included (#14958)
- Meets **ANSI Z87.1+ high-impact** and **CAN/CSA Z94.3** standards

PRODUCT NO.	Old Code	Crown	Suspension	Mounting Pattern	Case Qty.
29076	3000012	Black	Pinlock	Universal Bracket Pin Pattern	12

JACKSON 14955 FACE SHIELD KIT



- Kit includes:
- 170-SB crown and headgear
 - Model 29092 F30 acetate window 9" x 15.5" x .040" clear shape D

JACKSON 14953 FACE SHIELD KIT



- Kit includes:
- 170-SB crown and headgear
 - Model 30706 F20 high impact polycarbonate window 8" x 15.5" x .040" clear shape E

FACE SHIELDS – HARD HAT ADAPTOR BRACKETS

JACKSON SAFETY® FACE SHIELD HARD HAT ADAPTOR BRACKETS

- Jackson Safety® carries the widest range of face shield hard hat adaptors anywhere
- Range covers adaptors for slotted and non-slotted, regular, and wide brim hard hats
- Available in regular and dielectric models
- All models incorporate the popular universal bracket pin pattern for use with universal mount windows
- Swivel locking pins securely mount windows to bracket
- Vertical lock-in eliminates face shield creep

Model A-5500X Slotted Cap Adaptor

- A basic face shield hard hat adaptor bracket
- Curved injection molded channel fits over the hard hat bill
- Vertical lock-in eliminates face shield creep
- Attaches to SC-6, Sentry III®, Charger®, and many other slotted hard hat brands

PRODUCT NO.	Old Code	Fits Hard Hat Type	Fits Windows	Case Qty.
14506	3000448	Cap Style (Regular Brim)	Universal Windows	12

HHIS Slotted Cap Adaptor with Crown

- A Jackson Safety® exclusive
- Vertical lock-in eliminates face shield creep
- Oversized crown for added safety
- See page 105 for complete details and advantages of the Hard Hat Interchange System
- Attaches to SC-6, Sentry III®, Charger®, and many other slotted hard hat brands



PRODUCT NO.	Old Code	Fits Hard Hat Type	Fits Windows	Case Qty.
38425	N/A	Cap Style (Regular Brim)	Universal Windows	6

Model 82 B Slotted Cap Adaptor with Crown

- Vertical lock-in eliminates face shield creep
- Oversized crown for added safety
- Attaches to any hard hat using Jackson's model 87 Mounting Blades (#14939, above)
- #14941 82 B cap adaptor uses plastic detach mounting brackets
- #14949 82 BM cap adaptor uses metal detach mounting bracket



MADE IN USA

PRODUCT NO.	Old Code	Fits Hard Hat Type	Bracket	Fits Windows	Case Qty.
14941	3002438	Cap Style (Regular Brim)	Plastic	Universal Windows	12
14949	3002446	Cap Style (Regular Brim)	Metal	Universal Windows	12

Model 437 Slotted Cap Adaptor – Dielectric

- A popular style dielectric face shield hard hat adaptor bracket
- Curved injection molded channel fits over the hard hat bill
- Dielectric — made entirely of non-conductive materials
- Attaches to SC-6, Sentry III®, Charger®, and many other slotted hard hat brands

MADE IN USA

PRODUCT NO.	Old Code	Fits Hard Hat Type	Fits Windows	Case Qty.
14947	3002444	Cap Style (Regular Brim)	Universal Windows	12

Model 382 B Slotted Cap Adaptor with Crown – Dielectric

- Vertical lock-in eliminates face shield creep
- Oversized crown for added safety
- Dielectric — made entirely of non-conductive materials
- Attaches to SC-6, Sentry III®, Charger®, and many other slotted hard hat brands

MADE IN USA

PRODUCT NO.	Old Code	Fits Hard Hat Type	Fits Windows	Case Qty.
14944	3002441	Cap Style (Regular Brim)	Universal Windows	12
14951	3002449	Cap Style (Regular Brim)	Universal Windows	40 (Bulk)

JACKSON
SAFETY



14506



38425



Plastic

14941



Metal

14949



14947



14944/14951



14391



14948



14390



14943/14952



14942

FACE SHIELDS – HARD HAT ADAPTOR BRACKETS

FACE SHIELD BRACKETS FOR CAP STYLE NON-SLOTTED HARD HATS (REGULAR BRIM)

- Jackson offers five styles of face shield brackets for cap style (regular brim) hard hats
- Three models feature curved metal channels that fit over the hard hat brim
- Two models feature oversized crowns for added protection
- A hard hat face shield bracket for all applications

Model P Cap Adaptor

- Vertical lock-in eliminates face shield creep
- Curved metal channels fit over the hard hat brim
- Brackets feature durable expandable spring tensioner — self adjusts
- Features three easy-to-swivel lock mounting pins for universal windows
- Attaches to SC-6, Sentry III®, Charger®, and many other hard hat brands



PRODUCT NO.	Old Code	Fits Hard Hat Type	Fits Windows	Case Qty.
14391	3000034	Cap Style (Regular Brim)	Universal Windows	24

Model 137 Cap Adaptor

- Vertical lock-in eliminates face shield creep
- Curved metal channels fit over the hard hat brim
- Brackets feature durable expandable spring tensioner — self adjusts
- Features five easy-to-swivel lock mounting pins for universal windows
- Attaches to SC-6, Sentry III®, Charger®, and many other slotted hard hat brands



PRODUCT NO.	Old Code	Fits Hard Hat Type	Fits Windows	Case Qty.
14948	3002445	Cap Style (Regular Brim)	Universal Windows	12

Model C Cap Adaptor

- Vertical lock-in eliminates face shield creep
- Curved metal channels fit over the hard hat brim
- Can also be used with the hard hat in reverse donning mode
- Brackets feature durable expandable spring tensioner — self adjusts
- Features easy-to-swivel lock mounting pins for universal windows
- Attaches to SC-6, Sentry III®, Charger®, and many other hard hat brands



Reverse Donning

PRODUCT NO.	Old Code	Fits Hard Hat Type	Fits Windows	Case Qty.
14390	3000032	Cap Style (Regular Brim)	Universal Windows	24

Model 282-B Cap Adaptor with Crown

- Vertical lock-in eliminates face shield creep
- Oversized crown for added safety
- Specially designed metal clips press over the hard hat rim for maximum stability and firm fit
- Features five easy-to-swivel lock mounting pins for universal windows
- An extremely popular cap adaptor
- Attaches to SC-6, Sentry III®, Charger®, and many other hard hat brands



PRODUCT NO.	Old Code	Fits Hard Hat Type	Fits Windows	Case Qty.
14943	3002440	Cap Style (Regular Brim)	Universal Windows	12
14952	3002450	Cap Style (Regular Brim)	Universal Windows	40 (Bulk)

Model 182 B Cap Adaptor with Crown

- Vertical lock-in eliminates face shield creep
- Oversized crown for added safety
- Features five easy-to-swivel lock mounting pins for universal windows
- Attaches to SC-6, Sentry III®, Charger®, and many other hard hat brands



PRODUCT NO.	Old Code	Fits Hard Hat Type	Fits Windows	Case Qty.
14942	3002439	Cap Style (Regular Brim)	Universal Windows	12

FACE SHIELDS – HARD HAT ADAPTOR BRACKETS

FACE SHIELD BRACKETS FOR CAP STYLE NON-SLOTTED HARD HATS – DIELECTRIC

- Two models for use with most cap style, non-slotted hard hats
- Dielectric — made entirely of non-conductive materials
- Ideal for arc flash and electrical work

Model A-5500SN Non-Slotted Cap Adaptor – Dielectric

- A basic dielectric face shield hard hat adaptor bracket
- Curved injection molded channel fits over the hard hat bill
- Features adjustable rubber cord headband that stretches around the cap crown for a secure fit
- Features three easy-to-swivel lock mounting pins for universal windows
- Attaches to SC-6, Sentry III®, Charger®, and many other hard hat brands

PRODUCT NO.	Old Code	Fits Hard Hat Type	Fits Windows	Case Qty.
14505	3000447	Cap Style (Regular Brim)	Universal Windows	12



14505

Model 337 Non-Slotted Cap Adaptor – Dielectric

- A popular style dielectric face shield hard hat adaptor bracket
- Curved injection molded channel fit over the hard hat brim
- Features adjustable rubber strap headband that stretches around the cap crown for a secure fit
- Features five easy-to-swivel lock mounting pins for universal windows
- Attaches to SC-6, Sentry III®, Charger®, and many other hard hat brands

PRODUCT NO.	Old Code	Fits Hard Hat Type	Fits Windows	Case Qty.
14946	3002443	Cap Style (Regular Brim)	Universal Windows	12



14946

MADE IN USA

FACE SHIELD BRACKETS FOR FULL BRIM NON-SLOTTED HARD HATS (WIDE BRIM)

- Jackson offers two styles of face shield brackets for full brim hard hats
- Featuring curved metal channels that fit over the hard hat brim

Model H Cap Adaptor

- Vertical lock-in eliminates face shield creep
- Curved metal channels fit over the hard hat brim
- Brackets feature durable expandable spring tensioner — self adjusts
- Features three easy-to-swivel lock mounting pins for universal windows
- Attaches to Blockhead and many other full brim hard hat brands

PRODUCT NO.	Old Code	Fits Hard Hat Type	Fits Windows	Case Qty.
14393	3000038	Full Brim	Universal Windows	24



14393

For wide brim hard hats

Model 37 Cap Adaptor

- Vertical lock-in eliminates face shield creep
- Curved metal channels fit over the hard hat brim
- Brackets feature durable expandable spring tensioner — self adjusts
- Features five easy-to-swivel lock mounting pins for universal windows
- Attaches to Blockhead and many other full brim hard hat brands

PRODUCT NO.	Old Code	Fits Hard Hat Type	Fits Windows	Case Qty.
14945	3002442	Full brim	Universal Windows	12

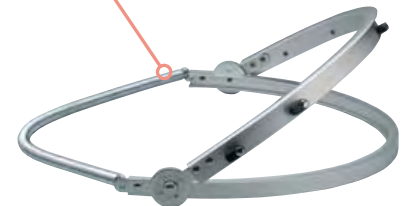

14945

MADE IN USA

MADE IN USA

sellstrom®



S61602



S61900



S61600



S61601



S61610



S61970

FACE SHIELDS – HARD HAT ADAPTOR BRACKETS

Face Shield Brackets for Non-Slotted Hard Hats

- Heavy-duty aluminum face shield bracket adaptors
- Brackets feature expandable spring tensioner — self adjusts
- Two bracket styles:
 - S61602 fits most wide brim hard hats
 - S61900 fits most cap style hard hats
- Three positive lock positions: down, 45 and 90 degree up
- Swivel-locking pins conveniently mount windows to bracket
- Universal bracket pin pattern is designed to accommodate most universal window brands

PRODUCT NO.	Fits Hard Hat Type	Fits Windows
S61602	Wide Brim	Universal Windows
S61900	Cap Style	Universal Windows

FACE SHIELDS – HARD HAT ADAPTOR BRACKETS – DIELECTRIC

- Dielectric — made entirely of non-conductive materials
- Ideal for arc flash and electrical work
- Brackets fit most cap style hard hat brims
- Three positive lock positions: down, 45 and 90 degree up
- Swivel-locking pins conveniently mount windows to bracket
- Universal bracket pin pattern is designed to accommodate most universal window brands

Face Shield Brackets for Non-Slotted Hard Hats — Dielectric

- Bracket features expandable rubber tensioner — self adjusts
- For non-slotted hard hats

PRODUCT NO.	Fits Hard Hat Type	Fits Windows
S61600	Cap Style	Universal Windows
S61601	Full Brim	Universal Windows

Face Shield Brackets for Slotted Hard Hats — Dielectric

- Bracket features universal hard hat slot adaptor
- For slotted cap style hard hats

PRODUCT NO.	Fits Hard Hat Type	Fits Windows
S61610	Cap Style	Universal Windows

UNIVERSAL SLOTTED HARD HAT ADAPTOR — DIELECTRIC

- Exclusive universal slotted hard hat adaptor makes mounting of Sellstrom face shields and/or welding helmets to slotted hard hats simple and easy
- Designed to fit Sellstrom's DP4, 380, and 390 Series face shields and 280, 290, Titan, and Smartweld welding helmets
- Dielectric — made entirely of non-conductive materials
- Provides an overall secure and tight mount

**MADE IN
USA**

PRODUCT NO.	Description	Fits Windows
S61970	Universal Slotted Hard Hat Adaptor	DP4, 280, 290, 380, 390 Series

EXCLUSIVE!

Hard Hat Interchange System

The All-In-One Safety Solution. Injuries can happen in a split second. Now it's easy to stay protected with the Jackson Safety® Hard Hat Interchange System. It lets you add, remove, or switch between your face shield or welding helmet, without removing your head protection.

In accordance with ANSI Z87.1, the system was designed to protect against multiple combinations of hazards. Remain safe, productive, and compliant with the Hard Hat Interchange System. It's worker preferred and safety manager enforced.

- Quickly switch between face shields and welding helmets without removing hard hats
- Meets ANSI standards when PPE products are used separately or combined
- Hear the audible click — Know your PPE is assembled correctly without the need for visual inspection
- One-button action provides quick release
- Vertical lock-in eliminates the annoyance of helmet creep
- HHIS headgear system comes fully assembled and ready to use
- Made from lightweight polypropylene
- Dielectric—Keeps your hard hat Class E rated!

	CODE	Description	Case Qty.
	39477	HHIS Master Kit contains all components necessary to mount welding helmets and face shields to your hard hat	6
	38423	Replacement HHIS kits for 14225/14235/14238 QUAD 500™	6
	38424	Replacement HHIS kits for 14202/14203 MAXVIEW™ and 14260/14262 F4XP	6
	38425	HHIS Face Shield Kit contains all components necessary to mount face shields to your hard hat	6
 Helmet not included	38426	HHIS Welding Helmet Kit contains all components necessary to mount welding helmets to your hard hat	6
	39476	Replacement mounting brackets for SC-6 series hard hats	6

Look for the Hard Hat Interchange System (HHIS) on these new Jackson products:



MAXVIEW™



14202, 14203

Quad 500™



14225, 14235, 14238

JACKSON
SAFETY



It's as Easy as 1, 2, 3!

1



Attach HHIS hard hat mounting bracket (with exclusive quick release button) to cap style slotted hard hat.

2



Attach HHIS hard hat mounting blades to any Jackson face shield or welding helmet product.

3



Pushing the HHIS quick release button allows fast and easy attachment/removal of face protection without ever removing your hard hat!



HHIS Mounting Brackets

HHIS Mounting Blades

- Used in conjunction with protective eyewear, Jackson Safety[®] face shields provide a high degree of on-the-job protection for heat applications as well as grinding, flying debris, splash protection, and more
- All Jackson Safety[®] face shields meet **ANSI Z87.1** Standards when used with any Jackson Safety[®] headgear (except for #28765)
- Universal bracket pin pattern is designed to accommodate most universal window brands including Kedman, Crews, Wilson, North, Jackson, and Sellstrom

F60	Wire Face Shields
F50	Polycarbonate Special Face Shields
F40	Propionate Face Shields
F30	Acetate Face Shields
F20	Polycarbonate Face Shields
F10	PETG Face Shields

MATERIAL TYPES		LENS TINTS
PETG	<ul style="list-style-type: none"> • A low-cost, recyclable option, ideal for general debris and splash protection 	<p>Clear Allows for maximum visible-light transmission.</p> <p>IRUV Worn for applications and in environments where others are performing welding tasks such as torch brazing, torch soldering, gas welding, and oxygen cutting. Available in Shades 3.0 and 5.0.</p> <p>SPECIAL TINTS Enhances vision and reduces glare by blocking light transmission. Available in light, medium, and dark green tints, as well as aluminum, copper, and gold coated to deflect heat in high-heat applications.</p> <p>WARNING: APPLICATIONS & SAFETY Face shields do not provide unlimited eye and face protection – primary eye protection (safety eyewear or goggles) must be worn.</p>
Polycarbonate	<ul style="list-style-type: none"> • Premium impact protection • Good performance against heat • Excellent cold flexibility • Excellent clarity 	
Acetate	<ul style="list-style-type: none"> • Robust combination of weight and strength • Excellent cold flexibility • Scratch and chemical resistant • Optimum clarity 	
Propionate	<ul style="list-style-type: none"> • Lightweight and chemical resistant 	
Wire Mesh	<ul style="list-style-type: none"> • Wear with face shield to dissipate heat • Ideal for flying-debris applications • Air flow for comfort 	

Recommended Applications	F10 PETG	F30 Acetate & F40 Propionate	F20 Polycarbonate & F50 Polycarbonate Special	F60 Wire Mesh
	GOOD	BETTER	BEST	
Light industrial manufacturing	●	●	●	
Cutting or grinding metal			● (IRUV only)	
Cutting wood			●	●
Splash (general)	●	●	●	
Impact		●	●	
High-heat applications			●	●
Landscaping	●	●	●	●
Food processing	●	●	●	
Scratch resistance		●		
High impact			●	



FACE SHIELDS – UNIVERSAL PIN MOUNT WINDOWS/VISORS



F10 PETG Face Shields

Meets ANSI Z87.1 Standards

PRODUCT NO.	Old Code	Shade	Dimensions (L" x W" x T")	Case Count	Shape	Bound	Compatible with Hard Hat Interchange System	MADE IN USA
28765*	3005392	Clear	6" x 15.5" x .040**	36	N	Unbound	●	●
28764**	NEW!	Clear AF	8" x 15.5" x .035"	96	N	Unbound	●	●
29107	NEW!	Clear AF	8" x 15.5" x .035"	96	E	Unbound	●	●
29104	3005399	Clear	8" x 15.5" x .040"	100	E	Unbound	●	●
29101	3005382	Medium Green	8" x 15.5" x .040"	36	E	Unbound	●	●
28962	3029190	Clear	9" x 15.5" x .040"	50	D	Bound	●	●
28963	3029191	Clear	9" x 15.5" x .040"	50	D	Unbound	●	●

For more information about the Hard Hat Interchange System, refer to page 105.

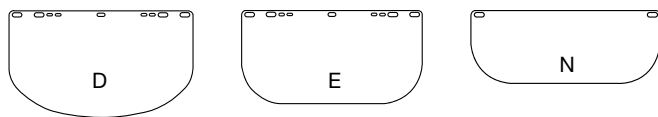

*Model 28765 does not meet ANSI Z87.1 standards due to limited coverage

**Please note: 28764 and 28765 windows are designed specifically to fit on Jackson bump caps with face shield attachment.

F20 Polycarbonate Face Shields



All models meet or exceed ANSI Z87.1+ high impact standards. Models 29087, 29106, and 30706 are CSA certified to CAN/CSA Z94.3 standards when combined with Jackson models 14260 F4XP headgear, or when combined with an SC-6 hard hat and 38425 HHIS hard hat adaptor.

PRODUCT NO.	Old Code	Shade	Dimensions (L" x W" x T")	Case Count	Shape	Bound	Compatible with Hard Hat Interchange System	MADE IN USA
30706*	3005372	Clear	8" x 15.5" x .040"	36	E	Unbound	●	●
29097*	3005373	Medium Green	8" x 15.5" x .040"	36	E	Unbound	●	●
29100*	3005379	Dark Green	8" x 15.5" x .040"	36	E	Unbound	●	●
29096*	3005371	Clear	8" x 15.5" x .040"	25	E	Bound	●	●
29099*	3005378	Clear	8" x 15.5" x .040"	36	F	Unbound	●	●
▲ 29062*	3000449	Clear	8" x 15.5" x .040"	12	T	Unbound	●	●
29087*	3002832	Clear	8" x 15.5" x .060" (Molded)	12	B	Unbound	●	●
29109*	3009492	Clear	8" x 15.5" x .060"	12	E	Unbound	●	●
14132*	3005375	Clear	8" x 15.5" x .060"	36 (bulk)	E	Unbound	●	●
29106*	NEW!	Clear	9" x 15.5" x .040"	96	D	Bound	●	●
29057*	NEW!	Clear	9" x 15.5" x .060" (Molded)	12	R	Unbound	●	●
29103*	3005385	Clear	9" x 19.25" x .060"	36	L	Unbound	●	●
29098	3005377	Clear	10" x 20" x .040"	36	K	Unbound	●	●

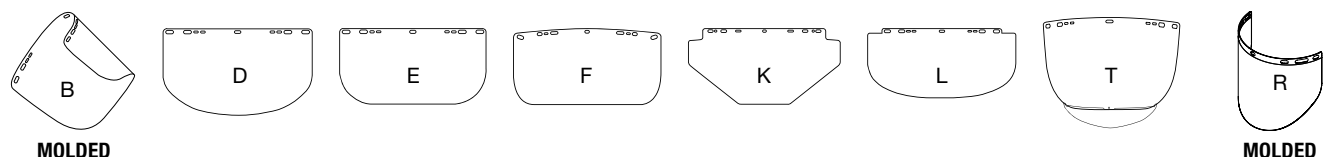

*CSA Z94.3 Compliant
▲ Chin Cup



F30 Acetate Face Shields

Meets ANSI Z87.1 Standards							
CODE	Old Code	Shade	Dimensions (L" x W" x T")	Case Count	Shape	Bound	Compatible with Hard Hat Interchange System
29078 ²	3002806	Clear	8" x 12" x .040"	24	C	Bound	● ●
29052	3000122	Clear	8" x 15.5" x .040"	24	E	Bound	● ●
29053	3000123	Medium Green	8" x 15.5" x .040"	24	D	Bound	● ●
29054	3000125	Clear	8" x 15.5" x .060"	24	E	Bound	● ●
▲ 29060	3000411	Clear	9" x 15" x .040"	24	P	Unbound	● ●
29092	NEW!	Clear	9" x 15.5" x .040"	35	D	Unbound	● ●
29079	3002808	Clear	9" x 15.5" x .040"	24	D	Bound	● ●
29091	3002848	Clear	9" x 15.5" x .040"	50 (Bulk)	D	Bound	● ●
29082	3002817	Light Green	9" x 15.5" x .040"	12	D	Bound	● ●
29090	3002845	Dark Green	9" x 15.5" x .040"	50	D	Bound	● ●
29083	3002826	Clear	9" x 19.5" x .040"	12	I	Unbound	● ●
29056	3000136	Clear	9" x 19.5" x .040"	24	O	Unbound	● ●
▲ 14445	3000146	Clear	9" x 20" x .040"	12	Q	Unbound	● ●

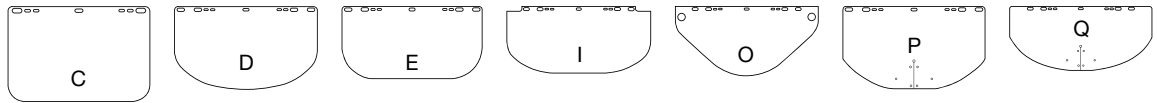

▲ Chin Cup

² Face Shield 29078 does not meet ANSI Z87.1 splash protection requirements when used with headgear 29076

F40 Propionate Face Shields – Molded



Meets ANSI Z87.1 Standards							
CODE	Old Code	Shade	Dimensions (L" x W" x T")	Case Count	Shape	Bound	Compatible with Hard Hat Interchange System
29084	3002830	Clear	9" x 15.5" x .060"	12	G	Unbound	● ●
29089	3002843	Clear	9" x 15.5" x .060"	50 (Bulk)	G	Unbound	● ●
29086	3002831	Dark Green	9" x 15.5" x .060"	12	G	Unbound	● ●
28766	3000175	Clear	10" x 20" x .060"	1	H	Unbound	● ●

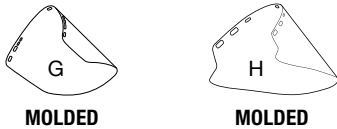

F50 Polycarbonate Special Face Shields – Molded – Premium Clarity & Impact Protection



All models meet or exceed ANSI Z87.1+ high impact standards. Model 29080 is CSA certified to CAN/CSA Z94.3 standards when combined with Jackson models 14260 F4XP headgear, or when combined with an SC-6 hard hat and 38425 HHIS hard hat adaptor.

CODE	Old Code	Shade	Dimensions (L" x W" x T")	Case Count	Shape	Bound	Compatible with Hard Hat Interchange System
26262*	3002813	IRUV 3.0	8" x 15.5" x .060"	12	B	Unbound	●
29080*	3002810	IRUV 5.0	8" x 15.5" x .060"	12	B	Unbound	●
28633*	3002838	IRUV 5.0	8" x 15.5" x .060"	50 (Bulk)	B	Unbound	●
29058	NEW!	IRUV 3.0	9" x 15.5" x .060"	12	R	Unbound	●
29059	NEW!	IRUV 5.0	9" x 15.5" x .060"	12	R	Unbound	●
28634*	3000162	Gold	10" x 20" x .060"	1	H	Unbound	●
29075	NEW!	Alum	10" x 20" x .060"	12	R	Unbound	●
29085	NEW!	Copper	10" x 20" x .060"	12	R	Unbound	●
29088	NEW!	Gold	10" x 20" x .060"	12	R	Unbound	●

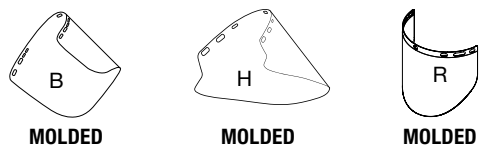

Aluminum – Basic heat deflection/protection
 Copper – Medium-to-high heat deflection/protection
 Gold – High heat deflection/protection

F60 Wire Mesh Face Shields

Meets ANSI Z87.1 Standards

CODE	Old Code	Shade	Dimensions (L" x W" x T")	Case Count	Shape	Bound	Other
29102 ³	3005383	Mesh	6.5" x 15.5" x .020"	30	N	Bound	6513 Mesh Steel
29055*	3000127	Mesh	8" x 15.5" x .020"	12	C	Bound	815 Mesh Steel
29081*	3002812	Mesh	9" x 15.5" x .016"	12	E	Bound	40 Mesh Steel

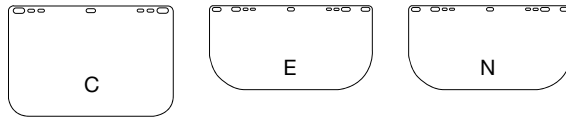

*CSA Z94.3 Compliant

³ Fits only with headgear codes 14381 and 29051.

Wire mesh face shields are not splash protectors. Not intended for high-impact protection. Apply over a face shield to dissipate heat.

Safe 2 Protection System

- System is designed for slotted caps
- Face shield bracket features an encapsulated stainless steel spring which ensures that the face shield stays in the selected position
- Face shields are shaped to follow the contours of the face
- Hard hat, bracket, face shield, and ear muffs all sold separately

CODE	Old Code	Description	Case Count
16797	3005410	Face Shield/Ear Muff Bracket (only)	1/Box
25973	3005401	Clear High Impact Polycarbonate Window – Bound	25/Box
16800	3005415	Face Shield – Nylon Mesh	1/Box
16799	3005413	Face Shield – Steel Mesh	1/Box
20776	3015091	Capmount Ear Muffs – Orange NRR 22	1/Box
20777	3015092	Capmount Ear Muffs – Red NRR 25	1/Box
20778	3015093	Capmount Ear Muffs – Black NRR 27	1/Box



New! Jackson Safety® F4XP Universal Crown with 370 Speed Dial™ Ratcheting Headgear – Simply the

NEW!

Oversized crown built with premium high impact rated material for maximum protection

For use with all universal pin pattern windows including over 40 Jackson models

Designed to offer maximum protection, ease-of-use, and extreme comfort and fit

(14262) F4XP Kit features premium 8" x 15.5" x .060" molded polycarbonate window (29087)



14262

Exclusive quick-change install and removal system ensures fast and efficient window changes

370
SPEED DIAL

Speed Dial 370™ headgear offers the fastest, easiest, and most efficient ratcheting headgear system in the industry

Hard Hat Interchange system available



sellstrom®



S37040



S37701



S37606

FACE SHIELDS – UNIVERSAL PIN MOUNT WINDOWS/VISORS

- Sellstrom offers a wide range of universal pin pattern windows to meet your every need
- All models meet **ANSI Z87.1+ high-impact** standards



PRODUCT NO.	Dimensions (L" x W" x T")	Description	Compatible with Hard Hat Interchange System
S37040	8" x 16" x .040"	Clear Molded Acetate Window – Anti-Fog	●
S37050	8" x 16" x .060"	Shade 5 IR Acetate Window	●
S37600	8" x 15.5" x .040"	Clear Aluminum Bound Window	●
S37601	8" x 15.5" x .040"	Clear Polycarbonate Window	●
S37701	9" x 15" x .060"	Clear Molded Spherical PC Window – V-Shape	●

Please note: These universal windows mount on all Sellstrom and Jackson universal pin mount window systems, such as F4XP, 170-SB, Model K, and 301 Series headgear, as well as all hard hat adapters

FACE SHIELD WINDOWS – FIBRE-METAL®

- Sellstrom carries replacement windows for three Fibre-Metal® face shield models: 4118, 4178, and 4199
- Meet **ANSI Z87.1+ high impact** standards

PRODUCT NO.	Dimensions (L" x W" x T")	Description	Fits Fibre Metal Crown
S37606	8" x 11" x .040"	Clear Polycarbonate	4118
S37607	8" x 16.5" x .040"	Clear Polycarbonate	4178
S37608	9.75" x 19" x .040"	Clear Polycarbonate	4199

Fibre-Metal® is a registered trademark of Honeywell.



FACE SHIELDS – SPLASH PROTECTION

MFS-320 Reusable Splash Face Shield

- Ideal for splash protection against liquids and body fluids for healthcare workers, first responders, and in food processing applications
- Safeguards against splash and dust in a wide range of general use applications
- Easy-to-install/replace window — quickly snap on or off the headband for maximum convenience
- Extra-large full face coverage for superior protection — check and compare!
- Reusable design — significantly reduces landfill waste and saves on disposal costs!
- Window features an anti-fog coating not found on most other face shields — keeps your vision clear and safe!
- Baseball cap-style pinlock head strap ensures quick and easy adjustments — just set it and forget it!
- Window and headband made with recyclable materials and are both replaceable
- A premium yet cost-effective face shield solution — a Jackson Safety exclusive
- Not designed for use in high impact applications!
- Meets **ANSI Z87.1 D3** standards

MADE IN USA



JACKSON
SAFETY



14350

PRODUCT NO.	Window	Dimensions (L" x W" x T")	Window Shape	Window Tint	Headband	Sweatband	Case Qty.
14350	PET Anti-Fog	9" x 14" x .020"	E	Clear	LDPE Pinlock	#1 Density PU Foam	24
Window Replacement Product No.				Sweatband Replacement Product No.			
14355 (35/case)				14356 (24/case)			

Manufactured in an FDA-registered facility and FDA listed. Packaging displays a health industry bar code.

PRODUCT NO.	UDI Number
14350	+B954143501+

SureWerx does not warrant that use of this product will prevent infection by viruses or microorganisms and assumes no liability.

A JACKSON EXCLUSIVE!







sellstrom[®]

JACKSON[®]
SAFETY

EYE PROTECTION SAFETY GLASSES

CLEARLY ESSENTIAL



LEGENDARY STYLE & PERFORMANCE!

NEW!

Frames are lightweight for all-day comfort

Specially formulated ultra-strong material provides unmatched durability and toughness

Soft touch temples are slip resistant and provide comfort for hours on end

Wraparound-style lenses extend protection to the periphery

Variety of styles available for maximum safety and productivity

Soft nose piece offers superior comfort

Meets Z87.1 ANSI specifications and provides 99.9% U.V. protection

All models come complete with a convenient neck cord to prevent loss

All standard packs of 12 come with an attractive ready-to-use retail dispenser box

JACKSON® SG SAFETY GLASSES — PREMIUM

JACKSON® SG Series Safety Glasses

- Introducing the all new JACKSON® SG series, a premium eye protection product offering outstanding fit, comfort, protection, style, and durability
- Specially designed to offer maximum eye coverage and protection, incorporating a variety of lens shades and coatings
- Made with premium virgin polycarbonate high impact, optically correct wrap style lenses, providing 99.9% UV protection
- Soft temples are curved inwards from front to back to ensure a super comfortable, slip-resistant fit
- As an added advantage, the temple tips are extremely flexible, further ensuring a snug fit while relieving any undue pressure to the user — these glasses are extremely comfortable and stay on during use!
- Frames have been developed using a specially formulated ultra-flexible, ultra-strong base material that provides incredible durability, significantly reducing breakage — check and compare!
- The lightweight frame includes a soft non-allergic nose pad for maximum comfort and fit
- Each safety glass comes complete with a convenient neck strap — no more misplaced or lost glasses!
- All models meet or exceed **ANSI Z87.1+ high impact** standards
- Models 50000, 50001, 50002, 50004, 50006, 50010, 50040, 50041, 50042 are **CSA certified to CAN/CSA Z94.3 standards**
- Models 50000, 50002, 50004, 50005, 50006, 50008, 50009, 50010; 50040, 50041, 50042 **CE certified**
- Available in three styles — framed, framed polarized, and frameless



Extreme Flexibility and Strength for Maximum Durability and Life!

SAFETY GLASSES — PREMIUM SERIES

NEW!

JACKSON
SAFETY

JACKSON® SG Series Safety Glasses — Framed

PRODUCT NO.	Frame Color	Lens Color	Lens Coating	Pack Qty.	Case Qty.
50000	Black	Clear	Hardcoat Anti-Scratch	12/Box	144
50001	Black	Clear	Anti-Fog	12/Box	144
50002	Black	Amber	Hardcoat Anti-Scratch	12/Box	144
50003	Black	Amber	Anti-Fog	12/Box	144
50004	Black	Indoor/Outdoor	Hardcoat Anti-Scratch	12/Box	144
50005	Black	Blue Shield	Hardcoat Anti-Scratch	12/Box	144
50006	Black	Smoke Mirror	Hardcoat Anti-Scratch	12/Box	144
50007	Black	Smoke Mirror	Anti-Fog	12/Box	144
50009	Black	Blue Mirror	Hardcoat Anti-Scratch	12/Box	144
50011	Blue	Light Blue	Hardcoat Anti-Scratch	12/Box	144
50012	Camo	Clear	Anti-Fog	12/Box	144
50013	Camo	Amber	Anti-Fog	12/Box	144
50014	Camo	Bronze	Hardcoat Anti-Scratch	12/Box	144
50015	Camo	Smoke	Hardcoat Anti-Scratch	12/Box	144
50016	Red	Smoke	Hardcoat Anti-Scratch	12/Box	144



50000



50002



50006



50012

JACKSON SAFETY

EYE PROTECTION



JACKSON[®]

SAFETY



50010

JACKSON[®] SG INFRARED

- Safeguards workers from “welder’s flash”
- For use with torch soldering, brazing and cutting

PRODUCT NO.	Frame Color	Lens Color	Lens Coating	Pack Qty.	Case Qty.
50008	Black	IR 3.0	Hardcoat Anti-Scratch	12/Box	144
50010	Black	IR 5.0	Hardcoat Anti-Scratch	12/Box	144



50040

JACKSON[®] SG READERS

- Ideal for those who need reading glasses and impact protection at the same time

PRODUCT NO.	Frame Color	Lens Color	Lens Coating	Reader Strength	Pack Qty.	Case Qty.
50040	Black	Clear	Hardcoat Anti-Scratch	1.5	12/Box	144
50041	Black	Clear	Hardcoat Anti-Scratch	2.0	12/Box	144
50042	Black	Clear	Hardcoat Anti-Scratch	2.5	12/Box	144



50017

JACKSON[®] SG+ Series Polarized Safety Glasses – Framed

- These glasses incorporate all of the same outstanding features of the JACKSON[®] SG Series but offer the added advantage of polarized lenses for ultimate viewing in bright conditions

PRODUCT NO.	Frame Color	Lens Color	Lens Coating	Pack Qty.	Case Qty.
50017	Brown	Brown	Hardcoat Anti-Scratch	12/Box	144
50018	Gunmetal	Smoke	Hardcoat Anti-Scratch	12/Box	144





JACKSON® SGf Series Safety Glasses – Frameless

- Includes the same outstanding features as the Jackson SG but made with a frameless design for lighter weight and edge-to-edge vision

PRODUCT NO.	Frame Color	Lens Color	Lens Coating	Pack Qty.	Case Qty.
50025	Gunmetal	Clear	Hardcoat Anti-Scratch	12/Box	144
50026	Gunmetal	Clear	Anti-Fog	12/Box	144
50027	Gunmetal	Indoor/Outdoor	Hardcoat Anti-Scratch	12/Box	144
50028	Gunmetal	Smoke	Hardcoat Anti-Scratch	12/Box	144
50029	Gunmetal	Blue Mirror	Hardcoat Anti-Scratch	12/Box	144
50030	Gunmetal	IR 5.0	Hardcoat Anti-Scratch	12/Box	144
50031	Camo	Bronze	Hardcoat Anti-Scratch	12/Box	144



50028



50031



SAFETY GLASSES — PREMIUM SEALED



S71910

- Sealed safety glasses offer the best of both worlds — the comfort and fit of a safety glass with goggle-like protection
- Features a fire-resistant closed cell foam insert that seals the glass to your face
- Provide maximum protection in dusty, windy conditions and wherever airborne particles are present
- Foam insert features top and bottom vent ports allowing superior air circulation
- Curved, custom molded high-impact polycarbonate lenses provide exceptional panoramic views
- Made with premium virgin polycarbonate high-impact lenses
- Lenses are specially coated with Sellstrom's premium Sta-Clear® anti-fog/anti-scratch washable lens treatment for maximum performance, durability, and life
- Virtually 100% fog free for optimum operator safety
- Provide 99.9% UV protection
- All models meet or exceed **ANSI Z87.1+ high impact** standards, **CSA certified to CAN/CSA Z94.3** standards and model XPS502 is tested to the **U.S. Military Standard MIL-PRF-31013** safety requirement of 640 feet per second

FOG FREE!

SAFETY GLASSES – PREMIUM SEALED

XPS502 Sealed Safety Glasses

- Features flexible, soft temples that are permanently attached to the frame using a heavy-duty ratcheting (up or down) temple adjustment hinge
- Allows the user to adjust temples for maximum comfort and protection
- Includes a cloth strap that conveniently attaches to the temples
- Detachable strap can be easily removed/re-attached as desired
- Ballistic rated — meets **US Military Standard MIL-PRF-31013** requirement
- 12/box, 144/case

BEST

PRODUCT NO.	Color	Tint	Lens Coating	Temple	Strap
S71910	Black/Orange	Clear	Sta-Clear® Anti-Fog/Hard Coated	Soft	FR Cloth
S71911	Black/Orange	Smoke	Sta-Clear® Anti-Fog/Hard Coated	Soft	FR Cloth
S71912	Black/Orange	I/O	Hard Coated	Soft	FR Cloth

XPS530 Sealed Safety Glasses

- The XPS530 comes standard with both detachable soft co-molded temples and a fire resistant cloth strap which are easily interchangeable
- Outstanding style, fit, comfort, and safety
- 12/box, 144/case

PRODUCT NO.	Color	Tint	Lens Coating	Temple	Strap
S70000	Yellow/Black	Clear	Sta-Clear® Anti-Fog/Hard Coated	Co-mold	FR Cloth
S70001	Yellow/Black	Smoke	Sta-Clear® Anti-Fog/Hard Coated	Co-mold	FR Cloth
S70002	Yellow/Black	I/O	Hard Coated	Co-mold	FR Cloth

XPS530 safety glasses include both detachable temple arms and straps.

Model S70000 shown with fire-resistant rated strap (included).

sellstrom®

Permanent temple arms,
removable strap



S71911

Heavy duty ratcheting
temple adjustment
hinge (up or down)



S70000



S70001

sellstrom®

BEST**

S72300

SAFETY GLASSES — PREMIUM SERIES

FOG FREE!

- Sellstrom offers a wide range of super premium, high quality safety glasses
- Rich in style, comfort, fit and safety
- Each model has been designed to exceed the needs of the most demanding user
- Made with premium virgin polycarbonate high impact lenses
- Lenses are specially coated with Sellstrom's premium Sta-Clear® anti-fog/anti-scratch washable lens treatment for maximum performance, durability and life
- Virtually 100% fog free for optimum operator safety
- Provide 99.9% UV protection
- All models meet or exceed **ANSI Z87.1+ high impact** standards, CSA certified to **CAN/CSA Z94.3** standards and tested to the **U.S. Military Standard MIL-PRF-31013** safety requirement of 640 feet per second

XP410 Safety Glasses

- The XP410 offers feather light frames, great style, maximum comfort & fit
- So light, you won't even remember you have them on!
- High-impact optically correct wrap style unitary PC lens offers superior coverage
- Stylish, ultra-thin black/green co-molded temples
- Temples are curved inwards to ensure comfortable, slip-resistant fit
- Temple tips are curved outwards for gentle placement and removal
- Soft, co-molded above-the-eye band provides superior eye coverage
- Soft, co-molded nose piece with flexible fingers ensures maximum comfort



S72000



S72001

PRODUCT NO.	Temple Color	Lens Tint	Lens Coating	Pack Qty.	Case Qty.
S72000	Black/Green	Clear	Sta-Clear® Anti-Fog/Hard Coated	12/Box	144
S72001	Black/Green	Smoke	Sta-Clear® Anti-Fog/Hard Coated	12/Box	144
S72002	Black/Green	I/O	Hard Coated	12/Box	144

SAFETY GLASSES – PREMIUM SERIES

XP420 Safety Glasses

- The XP420 offers a sporty, stylish heavy duty frame and temple design
- High-impact optically correct wrap style unitary PC lens offers superior coverage
- Soft, flexible temples with ribbed tips are curved inwards to ensure comfortable, slip-resistant fit
- Soft nose piece offers all day comfort

BEST

PRODUCT NO.	Temple Color	Lens Tint	Lens Coating	Pack Qty	Case Qty.
S72100	Black	Clear	Sta-Clear® Anti-Fog/Hard Coated	12/Box	144
S72101	Black	Smoke	Sta-Clear® Anti-Fog/Hard Coated	12/Box	144
S72102	Black	I/O	Hard Coated	12/Box	144

XP450 Safety Glasses

- The XP450 is our sportiest looking safety glass
- Edgy, sleek and modern co-molded temples offer outstanding style and comfort
- High-impact optically correct wrap style two-piece PC lenses offer superior coverage
- Lenses are mounted to the frame with a ventilation space, minimizing fogging
- Temples are curved inwards to ensure comfortable, slip-resistant fit
- Temple tips are curved outwards for gentle placement and removal
- Soft nose piece offers all day comfort

PRODUCT NO.	Temple Color	Lens Tint	Lens Coating	Pack Qty	Case Qty.
S72300	Black/Red	Clear	Sta-Clear® Anti-Fog/Hard Coated	12/Box	144
S72301	Black/Red	Smoke	Sta-Clear® Anti-Fog/Hard Coated	12/Box	144
S72302	Black/Red	I/O	Hard Coated	12/Box	144

XP460 Safety Glasses

- The XP460 offers a sporty, stylish heavy duty frame and temple design
- Our only full frame premium safety glass
- High-impact optically correct two-piece PC lenses offer superior coverage
- Stylish black/green co-molded temples and soft nose piece offers all day comfort
- Temples are curved inwards to ensure comfortable, slip-resistant fit
- Temple tips are curved outwards for gentle placement and removal

PRODUCT NO.	Temple Color	Lens Tint	Lens Coating	Pack Qty	Case Qty.
S72400	Black/Green	Clear	Sta-Clear® Anti-Fog/Hard Coated	12/Box	144
S72401	Black/Green	Smoke	Sta-Clear® Anti-Fog/Hard Coated	12/Box	144
S72402	Black/Green	I/O	Uncoated	12/Box	144

sellstrom®



S72100



S72101



S72300



S72301



S72400



S72401

sellstrom®



S71100



S71101

Up/down three-position ratcheting temples



S71200



S71201



S71203

SAFETY GLASSES – ADVANTAGE PLUS SERIES

- Advantage Plus safety glasses offer additional features over our Advantage Series products, providing the user with increased comfort and fit
- All glasses are made using virgin polycarbonate lenses
- Provide 99.9% UV protection
- Lenses feature an anti-scratch hard coating
- Ideal for those applications where safety, comfort, fit, and affordability are of primary importance
- All models meet or exceed **ANSI Z87.1+ high impact** standards, **CSA certified to CAN/CSA Z94.3** standards and tested to the **U.S. Military Standard MIL-PRF-31013** safety requirement of 640 feet per second (except XM300 Series)



XM300 Safety Glasses

- The XM300 safety glass is lightweight, stylish, comfortable and affordable
- High impact optically correct wrap style unitary PC lens offers superior coverage
- Stylish black/green co-molded temples and soft nose piece offers all day comfort
- Temples are curved inwards to ensure comfortable, slip-resistant fit
- Temple tips are curved outwards for gentle placement and removal

PRODUCT NO.	Temple Color	Lens Tint	Lens Coating	Pack Qty.	Case Qty.
S71100	Black/Green	Clear	Hard Coated	12/Box	144
S71101	Black/Green	Smoke	Hard Coated	12/Box	144
S71102	Black/Green	I/O	Hard Coated	12/Box	144

XM310 Safety Glasses

- The XM310 safety glass is lightweight, stylish, comfortable and very affordable
- High impact optically correct wrap style unitary PC lens offers superior coverage
- Molded above-the-eye band provides superior coverage
- Stylish black/orange co-molded temples and soft nose piece offers all day comfort
- Up/down three-position ratcheting temples allows user to adjust for maximum fit
- Temples are curved inwards to ensure comfortable, slip-resistant fit
- Temple tips are curved outwards for gentle placement and removal

PRODUCT NO.	Temple Color	Lens Tint	Lens Coating	Pack Qty.	Case Qty.
S71200	Black/Orange	Clear	Hard Coated	12/Box	144
S71201	Black/Orange	Smoke	Hard Coated	12/Box	144
S71202	Black/Orange	I/O	Hard Coated	12/Box	144
S71203	Black/Orange	Amber	Hard Coated	12/Box	144

SAFETY GLASSES – ADVANTAGE PLUS SERIES

XM320 Safety Glasses

- The XM320 offers a sporty, stylish heavy duty frame and temple design
- High impact optically correct unitary PC lens offers integrated side panel — incredible front and side eye coverage
- Stylish flat black and orange co-molded temples are soft and flexible
- Temples are curved inwards to ensure comfortable, slip-resistant fit
- Soft nose piece offers all day comfort



PRODUCT NO.	Temple Color	Lens Tint	Lens Coating	Pack Qty	Case Qty.
S71400	Black/Orange	Clear	Hard Coated	12/Box	144
S71401	Black/Orange	Smoke	Hard Coated	12/Box	144
S71402	Black/Orange	I/O	Hard Coated	12/Box	144

XM330 Safety Glasses

- The XM330 safety glass is lightweight, stylish, comfortable and very affordable
- Our most popular mid-range safety glass!
- High impact optically correct wrap style unitary PC lens offers superior coverage
- Soft, flexible temple tips and soft nose piece offers all day comfort
- Temples are curved inwards to ensure comfortable, slip-resistant fit
- Temple tips are curved outwards for gentle placement and removal

PRODUCT NO.	Temple Color	Lens Tint	Lens Coating	Pack Qty	Case Qty.
S73601	Clear/Black	Clear	Hard Coated	12/Box	144
S73611	Amber/Black	Amber	Hard Coated	12/Box	144
S73621	Smoke/Black	Smoke	Hard Coated	12/Box	144
S73631	Clear/Black	I/O	Hard Coated	12/Box	144

XM340 Safety Glasses (Old PT9)

- The XM340 safety glass is lightweight, stylish & comfortable
- High impact optically correct wrap style dual PC lenses offer superior coverage
- Lenses are mounted to the frame with a ventilation space, minimizing fogging
- Soft rubberized temple tips and soft nose piece offers all day comfort
- Temples are curved inwards to ensure comfortable, slip-resistant fit
- Temple tips are curved outwards for gentle placement and removal

PRODUCT NO.	Temple Color	Lens Tint	Lens Coating	Pack Qty.	Case Qty.
S74201	Smoke/Smoke	Clear	Hard Coated	12/Box	144
S74241	Smoke/Smoke	I/O	Hard Coated	12/Box	144
S74271	Smoke/Smoke	Smoke	Hard Coated	12/Box	144

sellstrom®



S71400



S71401



S73601



S73611



S73621



S74201



S74271

sellstrom®



S70701



S70711



S70721



S73401



S73421



S73471



S79100

SAFETY GLASSES – ADVANTAGE SERIES

- Sellstrom offers a wide range of affordable safety glasses under the Advantage Series program
- All glasses are made using virgin, unitary polycarbonate lenses
- Provide 99.9% UV protection
- Ideal for construction, shop, and general eye protection applications

*
GOOD

X300 Safety Glasses

- The X300 style is one of the most popular selling safety glasses in North America
- Lightweight, comfortable and very affordable
- Lens features an anti-scratch hard coating
- All X300 safety glasses meet **ANSI Z87.1+ high impact** standards and are **CSA certified to CAN/CSA Z94.3** standards

PRODUCT NO.	Temple Color	Lens Tint	Lens Coating	Pack Qty	Case Qty
S70701	Clear	Clear	Hard Coated	12/Box	144
S70702	Clear	Clear	Anti-Fog	12/Box	144
S70711	Amber	Amber	Hard Coated	12/Box	144
S70721	Smoke	Smoke	Hard Coated	12/Box	144
S70731	Clear	I/O	Hard Coated	12/Box	144

X330 Safety Glasses (Old Firebird)

- The X330 style is one of the most popular selling safety glasses in North America
- Lightweight, comfortable and very affordable
- Lens features an anti-scratch hard coating
- Soft rubberized temple tips ensure superior comfort and fit
- All X330 safety glasses meet **ANSI Z87.1+ high impact** standards and are **CSA certified to CAN/CSA Z94.3** standards

PRODUCT NO.	Temple Color	Lens Tint	Lens Coating	Pack Qty	Case Qty
S73401	Clear	Clear	Hard Coated	12/Box	144
S73402	Clear	Clear	Anti-Fog	12/Box	144
S73421	Amber	Amber	Hard Coated	12/Box	144
S73471	Smoke	Smoke	Hard Coated	12/Box	144
S73481	Smoke	Blue Mirror	Hard Coated	12/Box	144

X350 Safety Glasses (OTG)

- Lightweight, comfortable and affordable
- Sleek, modern look offers front, side and above/below-the-eye protection
- Designed to fit over most medium sized prescription eyewear (OTG)
- Comfortable nose bridge
- Ideal as a visitors spec as well as for everyday eye protection
- Meets **ANSI Z87.1+ high impact** standards and are **CSA certified to CAN/CSA Z94.3** standards
- Tested to **U.S. Military Standard MIL-PRF-31013** safety requirement of 640 feet per second

PRODUCT NO.	Temple Color	Lens Tint	Lens Coating	Pack Qty	Case Qty
S79100	Clear	Clear	Hard Coated	12/Box	144

SAFETY GLASSES – ADVANTAGE SERIES

Sebring™ Safety Glasses

- Classic one-piece molded lens offers excellent front/side protection
- Lightweight, comfortable and very affordable
- Arms are extendable for maximum fit and comfort
- S73801 and S73802 offer same features but with a smaller frame for narrow faces
- Meets **ANSI Z87.1+ high impact** standards and the following are **CSA certified to CAN/CSA Z94.3** standards: S73801, S76301, and S76371

PRODUCT NO.	Temple Color	Lens Tint	Lens Coating	Pack Qty	Case Qty
S73801	Black (small frame)	Clear	Hard Coated	12/Box	144
S73802	Blue (small frame)	Clear	Hard Coated	12/Box	144
S76301	Black	Clear	Hard Coated	12/Box	144
S76341	Black	Mirror	Hard Coated	12/Box	144
S76361B	Black	Shade 6	Hard Coated	12/Box	144
S76371	Black	Smoke	Hard Coated	12/Box	144
S76701	Red, White, Blue	Clear	Hard Coated	12/Box	144
S76771	Red, White, Blue	Smoke	Hard Coated	12/Box	144

Maxview™ Safety Glasses

- Lightweight, comfortable and affordable
- Designed to fit over prescription eyewear (OTG)
- Ideal as a visitors' spec as well as for everyday eye protection
- Extra-wide ventilated temples for increased side protection
- Meets **ANSI Z87.1+ high impact** standards and the following are **CSA certified to CAN/CSA Z94.3** standards: S79301 and S79302

PRODUCT NO.	Temple Color	Lens Tint	Lens Coating	Pack Qty	Case Qty
S79301	Clear	Clear	Hard Coated	12/Box	144
S79302	Clear	Clear	Uncoated	12/Box	144
S79371	Smoke	Smoke	Hard Coated	12/Box	144
S79372	Smoke	Smoke	Uncoated	12/Box	144

Guest-Gard™ Safety Glasses

- Lightweight, comfortable and affordable
- Designed to fit over prescription eyewear (OTG)
- Ideal as a visitors' spec as well as for everyday eye protection
- Classic one-piece molded lens offers excellent front/side protection
- 79103 comes in convenient dispenser box — 24/box
- 79108 is bulk packed in quantities of 100
- Meets **ANSI Z87.1+ high impact** standards and are **CSA certified to CAN/CSA Z94.3** standards



S79103

PRODUCT NO.	Temple Color	Lens Tint	Lens Coating	Pack Qty	Case Qty
S79103	Clear	Clear	Uncoated	24/Dispenser Box	144
S79108	Clear	Clear	Uncoated	100/Bulk Packed	144

sellstrom®



S73801



S76301



S76701



S79301



S79103/S79108



S70703

Bifocal magnifiers



S74202

Bifocal magnifiers



S79901



S79904

SAFETY GLASSES – BIFOCALS

- Sellstrom offers two popular styles of bifocal magnifying safety glasses
- Developed for workers requiring magnifiers when performing close-vision tasks
- Available in three magnifying powers: 1.5, 2.0 & 2.5
- All glasses are made using virgin, unitary polycarbonate lenses
- Provide 99.9% UV protection
- Meets **ANSI Z87.1+ high-impact** standards

X300RX Safety Glasses

- The X300RX offers all of the same features as our popular X300 but with bifocal magnification technology
- Lightweight, comfortable, and very affordable
- Lens features an anti-scratch hard coating

PRODUCT NO.	Temple Color	Lens Tint	Lens Coating	Magnification	Pack. Qty	Case Qty.
S70703	Clear	Clear	Hard Coated	1.5x	12/Box	144
S70704	Clear	Clear	Hard Coated	2.0x	12/Box	144
S70705	Clear	Clear	Hard Coated	2.5x	12/Box	144

XM340RX Safety Glasses

- The XM340RX offers all of the same features as our popular XM340 but with bifocal magnification technology
- High-impact optically correct wrap style dual PC lenses offer superior coverage
- Lenses are mounted to the frame with a ventilation space, minimizing fogging
- Soft rubberized temple tips and soft nose piece offers all-day comfort
- Temples are curved inwards to ensure comfortable, slip-resistant fit
- Temple tips are curved outwards for gentle placement and removal

PRODUCT NO.	Temple Color	Lens Tint	Lens Coating	Magnification	Pack. Qty	Case Qty.
S74202	Smoke/Black	Clear	Hard Coated	1.5x	12/Box	144
S74203	Smoke/Black	Clear	Hard Coated	2.0x	12/Box	144
S74204	Smoke/Black	Clear	Hard Coated	2.5x	12/Box	144

SAFETY GLASSES – ACCESSORIES

PRODUCT NO.	Description
S79901	Black Padded Hard Case with Belt Clip Attachment
S79904	Black Sellstrom Safeguards Microfiber Bag

SAFETY GLASSES – SHADE 3 AND 5 IR

- Sellstrom offers three styles of safety glasses specifically for use in welding and fabrications shops
- B5 model is also available with clear lens
- Available in Shade 3 and Shade 5 IR for soldering, brazing and cutting operations
- All glasses are made with anti-scratch polycarbonate lenses
- Provide 99.9% UV protection

B5™ Safety Glasses

- Features fold-out contouring side shields for maximum eye protection
- Arms are extendable for maximum fit and comfort
- Dual polycarbonate lenses are available in clear and Shade 5 IR
- Meets or exceeds **ANSI Z87.1+ high impact** standards
- Model S74751 is **CE certified**

PRODUCT NO.	Temple Color	Side Shield	Lens Tint	Lens Coating	Pack Qty	Case Qty.
S74701	Black	Clear	Clear	Hard Coated	12/Box	144
S74751	Black	Black	Shade 5 IR	Hard Coated	12/Box	144

X35™ Safety Glasses

- Temple arms molded with side shields for maximum eye protection
- Features unique spring-loaded flip window
- It's easy and safe — by keeping the glasses on at all times, the operator can flip the shaded lenses up or down, providing uninterrupted eye protection during cutting and grinding operations
- Clear lens provides eye protection when the flip plate is in the up position
- Flip windows available in two Shades: 3 IR and 5 IR
- Meets or exceeds **ANSI Z87.1+ high impact** standards
- **CE certified**

PRODUCT NO.	Color	Fixed Lens	Flip Lens Tint	Lens Coating	Pack Qty	Case Qty.
S72903	Black	Clear	Shade 3 IR	Hard Coated	12/Box	144

sellstrom®



S74701



S74751

Fold-out contouring side shield



Unique Shade 3 or 5 IR flip-up lens

Clear "fixed" lens

S72905



sellstrom®

JACKSON®
SAFETY

EYE PROTECTION GOGGLES

FOCUSED ON SAFETY

sellstrom®

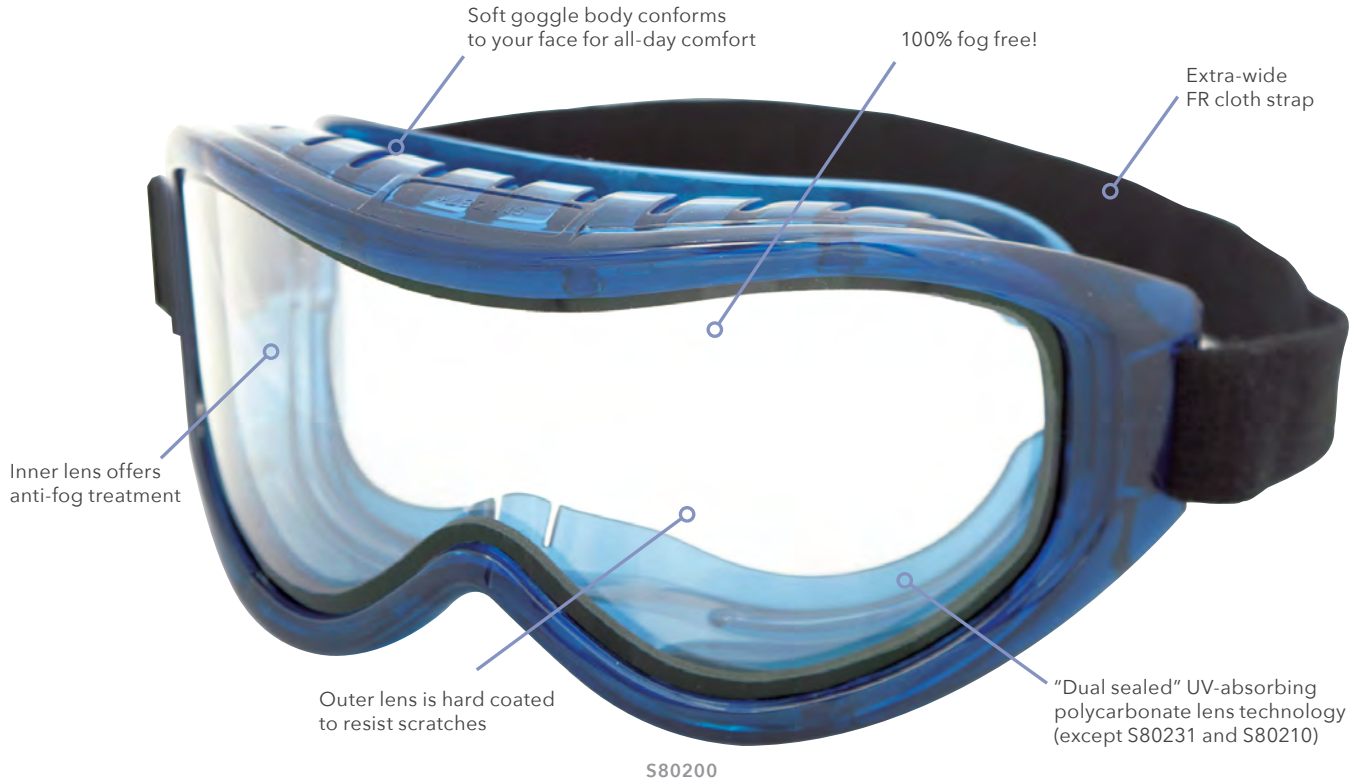

GOGGLES — PREMIUM

OVER
1 MILLION
GOGGLES
SOLD!



S80200

Odyssey II Safety Goggle Series

- The Odyssey II premium goggle series has been a market leader for 20 years
- Unique "dual sealed" UV absorbing polycarbonate lens technology (except single lens clean room and Shade 5 cutting models)
- Dual lens models offer anti-fog treatment on inside lens, anti-scratch on outside lens
- Industrial, chemical splash, and Shade 5 models feature top and bottom indirect vents, providing superior ventilation and the safest operator conditions
- 100% fog free, even in the worst conditions
- Stylish soft goggle body conforms to your face, providing a comfortable yet snug seal and maximum protection against liquids and dust
- Exceptional panoramic views
- Specially designed to fit over prescription eyewear
- Simply the best goggle in the market
- All models meet or exceed **ANSI Z87.1+ high impact** standards
- Models S80200, S80201, S80202, S80203, S80210, S80211, S80231 **CSA certified to CAN/CSA Z94.3** standards

GOGGLES – PREMIUM

Odyssey II Series Industrial Dual Lens Model

- Our most popular Odyssey II model
- Ideal for a wide variety of applications including construction sites, shop use, and general industrial work-place protection
- Complete with extra-wide flame retardant cloth strap (S80246)

BEST

PRODUCT NO.	Body Color	Vent Type	Lens	Coatings	Tint	Case Qty.
S80200	Blue	Indirect	Dual	Hard Coated/Anti-Fog	Clear	100

Odyssey II Series Chemical Splash Dual Lens Goggle

- Specifically designed for those applications where the risk of a chemical splash exists
- Available in three lens tints: clear, smoke and amber
- Complete with extra-wide gray, latex free neoprene strap

PRODUCT NO.	Body Color	Vent Type	Lens	Coatings	Tint	Case Qty.
S80201	Blue	Indirect	Dual	Hard Coated/Anti-Fog	Clear	100
S80202	Blue	Indirect	Dual	Hard Coated/Anti-Fog	Amber	100
S80203	Blue	Indirect	Dual	Hard Coated/Anti-Fog	Smoke	100

Odyssey II Series Tactical Dual Lens Goggle

- Specifically designed with high temperature vented body for police, prisons and military tactical applications
- Features a closed cell foam face seal design
- Complete with extra wide flame retardant strap

PRODUCT NO.	Body Color	Vent Type	Lens	Coatings	Tint	Case Qty.
S80290	Black (high temp)	Sealed	Dual	Hard Coated/Anti-Fog	Clear	100

Odyssey II Series Clean Room Goggle

- Specifically designed for clean room applications
- Unlike traditional single use clean room goggles, these premium goggles are re-usable and designed for multi-use clean room applications
- Can be autoclaved
- Top-vented body with clear uncoated lens
- **CE certified**
- Complete with extra-wide gray, latex free neoprene strap (S80251)

PRODUCT NO.	Body Color	Vent Type	Lens	Coatings	Tint	Case Qty.
S80231	Blue	Top-Vented	Single	Uncoated	Clear	100

sellstrom®



S80200



S80201



S80202



S80203



S80290



S80231

INCREDIBLE COMFORT & FIT!

sellstrom®



S80210



S80245



S79905

GOGGLES – PREMIUM

Odyssey II Series Shade 5 Cutting Goggle

- Features a durable Shade 5 IR (single) lens
- Specifically designed for grinding, chipping and brazing operations in fabrication and welding shop applications
- Complete with extra wide flame retardant strap (80246)

BEST

PRODUCT NO.	Body Color	Vent Type	Lens	Coatings	Tint	Case Qty.
S80210	Black (High Temp)	Indirect	Single	Uncoated	Shade 5 IR**	100
S80211	Black (High Temp)	Indirect	Single	Uncoated	Shade 5 IR*	100

*Packed in POS clamshell

**Packed in convenient polybag

Black Nylon Goggle Case c/w Belt Loop

PRODUCT NO.	Description	Fits Goggle Models
S80245	Black Padded Nylon Goggle Case	All Odyssey Goggles

Microfiber Bags for Odyssey II Goggles

PRODUCT NO.	Description	Fits Goggle Models
S79905	Black Microfiber Bag	All Odyssey II Goggles
S79906	Black Microfiber Bag	Wildland Fire Goggles

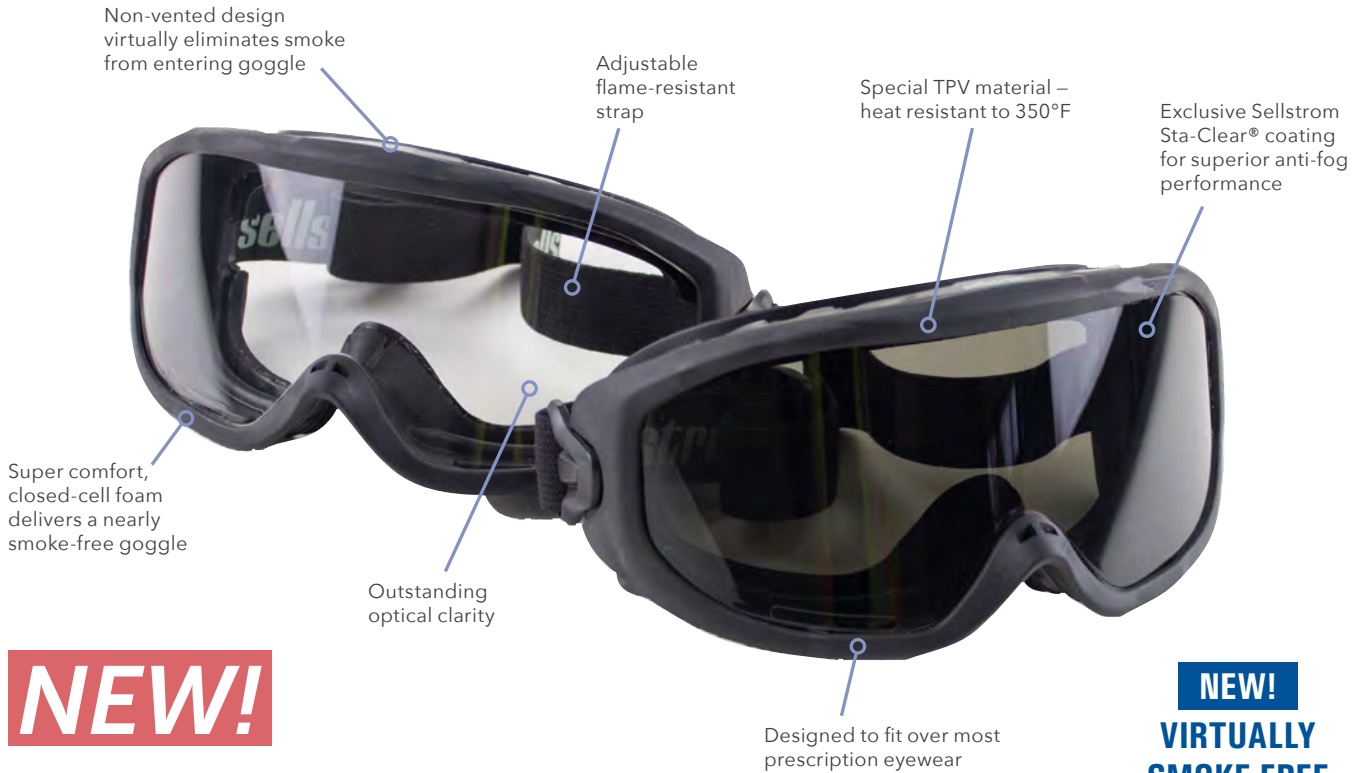

NEW!

GOGGLES – PREMIUM WILDLAND FIREFIGHTING

NEW!
VIRTUALLY SMOKE-FREE PERFORMANCE!

***** BEST**

Odyssey II Wildland Firefighting Goggles

- Specially designed for use in wildland firefighting applications
- TPV material construction is heat resistant to 350°F
- Non-vented style virtually eliminates smoke from entering goggle
- Closed-cell foam design offers a soft but firm seal and contributes to a smoke-free goggle
- Unique Sta-Clear® coating provides superior anti-fog performance
- Adjustable flame-resistant band for a custom fit
- Outstanding optical clarity and fits over prescription eyewear
- Meets **ANSI Z87.1+ high impact** standards



PRODUCT NO.	Body Color	Vent Type	Lens	Coatings	Tint	Case Qty.
580225	Black	Sealed	Single	Sta-Clear® Anti-Fog	Clear	144
580226	Black	Sealed	Single	Sta-Clear® Anti-Fog	Smoke	144





GOGGLES – PREMIUM SPECIALTY

NEW!



- Jackson introduces a new premium goggle with detachable flip-up/flip-down face shield
- Stylish super-soft goggle body conforms to your face, ensuring a comfortable snug seal and maximum protection against liquids and dust
- Indirect vents along with an anti-fog lens coating ensures a safe, fog-free working environment while offering superior protection against dust and chemical splashes
- Optically correct polycarbonate lens provide exceptional panoramic views
- Specially designed to fit over prescription eyewear
- Face shield is easily detachable

GOGGLES – PREMIUM SPECIALTY

GPL500 Series Premium Safety Goggle with Detachable Flip-Up/Flip-Down Face Shield

- The GPL500 features an added flip-up/flip-down polycarbonate face shield designed to protect your face from splash, dust, and flying debris
- Extra-wide flame retardant strap is swivel mounted to goggle
- Provides 99.9% UV protection
- Available in three tints: Clear, IRUV 3, and IRUV 5
- Clear version is ideal for industrial, mining, cutting, grinding, construction, woodworking, machine shop, and pressure washing applications
- Shade 3 IR goggle is coated to provide IR protection for oxy/acetylene cutting and light brazing applications
- Shade 5 IR goggle is coated to provide IR protection for oxy/acetylene cutting, brazing, and plasma cutting applications
- Meets **ANSI Z87.1+ high impact** standards
- Models 21000, 21002 **CSA certified to CAN/CSA Z94.3** standards
- 21000, 21001, 21002 **CE certified**

BEST

NEW!

PRODUCT NO.	Model No.	Body Color	Face Shield Color	Lens	Coatings	Tint	Case Qty.
21000	GPL500	Blue	Blue	Single	Anti-Fog	Clear	6
21001	GPL530	Black	Green	Single	Anti-Fog	Shade 3 IR	6
21002	GPL550	Black	Green	Single	Anti-Fog	Shade 5 IR	6

JACKSON
SAFETY



21000



21001
21002

GOGGLES – ADVANTAGE PLUS SERIES

GM500 Safety Goggle

- The GM500 goggle combines comfort, fit, safety, and great looks in one product
- Stylish orange/black co-molded soft TPR body provides comfort and fit
- Molded curved polycarbonate lens provides outstanding panoramic views with virtually no distortion
- Top and bottom indirect vents along with an anti-fog lens coating provides superior ventilation and a safe, fog-free working environment
- Indirect vents provide superior protection against dust and chemical splashes
- Swivel mounted, extra-wide flame retardant strap
- Specially designed to fit over prescription eyewear
- Provides 99.9% UV protection
- Meets **ANSI Z87.1+ high impact** standards and **CSA certified to CAN/CSA Z94.3** standards

**
BETTER

PRODUCT NO.	Body Color	Vent Type	Lens	Coatings	Tint	Case Qty.
S82500	Orange/Black	Indirect	Single	Anti-Fog	Clear	200

GM200 Safety Goggle

- The GM200 goggle combines comfort, fit, safety, and great looks in one product
- Super-soft smoke colored body is designed with extra-wide face seal lip for exceptional comfort and fit
- Molded optically correct polycarbonate lens provides panoramic views with little distortion
- Top and bottom indirect vents along with an anti-fog lens coating provides superior ventilation and a safe, fog-free working environment
- Indirect vents provide superior protection against dust and chemical splashes
- Extra-wide flame retardant strap
- Provides 99.9% UV protection
- All these features at an economical price — ideal for use in schools
- Meets **ANSI Z87.1+ high impact** standard

**
BETTER

PRODUCT NO.	Body Color	Vent Type	Lens	Coatings	Tint	Case Qty.
S82000	Smoke	Indirect	Single	Anti-Fog	Clear	200

sellstrom



S82500



S82000

sellstrom®

GOGGLES – ADVANTAGE SERIES (USA MADE)



880, 881, and 882 Series Safety Goggles

- Proudly made in the USA
- Green tinted flexible PVC body ensures proper fit
- Polycarbonate UV-absorbing clear lenses
- Three vent options available to fit your every need
- Adjustable 18" green flame-retardant headband (S22448)
- Available with anti-fog lens coating
- All models meet or exceed **ANSI Z87.1+ high impact** standards
- Models S88200, S88210 **CSA certified to CAN/CSA Z94.3** standards



S88000

880 Direct Vent Safety Goggles

- Direct vent series
- Provides maximum air flow and protection against flying debris

PRODUCT NO.	Body Color	Vent Type	Lens	Coatings	Packaged	Case Qty.
S88000	Green	Direct	Clear	Uncoated	1/Bag	36
S88003	Green	Direct	Clear	Uncoated	150 Bulk Nested	150
S88010	Green	Direct	Clear	Anti-Fog	1/Bag	36



S88110

881 Non-Vented Safety Goggles

- Non-vented series
- Offers best protection from liquids and dust particles

PRODUCT NO.	Body Color	Vent Type	Lens	Coatings	Packaged	Case Qty.
S88110	Green	Non-Vent	Clear	Anti-Fog	1/Bag	36



S88200

882 Indirect Vent Chemical Splash Safety Goggles

- Indirect vent chemical splash series
- Protects against liquid, dust, smoke, and chemical splash environments

PRODUCT NO.	Body Color	Vent Type	Lens	Coatings	Packaged	Case Qty.
S88200	Green	Indirect	Clear	Uncoated	1/Bag	36
S88210	Green	Indirect	Clear	Anti-Fog	1/Bag	36

GOGGLES – ADVANTAGE SERIES

810 and 812 Series Safety Goggles

- Our most economically priced goggle series
- Clear flexible PVC body ensures proper fit
- Polycarbonate UV-absorbing clear lenses
- Three vent options available to fit your every need
- Adjustable 18" black flame-retardant headband (S22448)
- Available with anti-fog lens coating
- 813 series come with padded face seal
- 830 and 832 series are mini versions for children, students, and small faces
- Meets **ANSI Z87.1+ high-impact** standards



810 Direct Vent Safety Goggles

- Direct vent series
- Provides maximum air flow and protection against flying debris
- Models S81000 and S81010 **CSA certified**

PRODUCT NO.	Body Color	Vent Type	Lens	Coatings	Packaged	Case Qty.
S81000	Clear	Direct	Clear	Uncoated	1/Bag	200
S81010	Clear	Direct	Clear	Anti-Fog	1/Bag	200

812 Indirect Vent Chemical Splash Safety Goggles

- Indirect vent chemical splash series
- Protects against liquid, dust, smoke, and chemical splash environments
- Model S81210 **CSA certified**

PRODUCT NO.	Body Color	Vent Type	Lens	Coatings	Packaged	Case Qty.
S81200	Clear	Indirect	Clear	Uncoated	1/Bag	160
S81210	Clear	Indirect	Clear	Anti-Fog	1/Bag	160
S81210E	Clear	Indirect	Clear	Anti-Fog	1/Bag	144 NEW!

812 Non-Vented Safety Goggles

- Non-vented goggle
- Offers best protection from liquids and dust particles
- Model S81220 is **CSA certified**

PRODUCT NO.	Body Color	Vent Type	Lens	Coatings	Packaged	Case Qty.
S81220	Clear	Non-Vent	Clear	Anti-Fog	1/Bag	200
S81220X	Green	Non-Vent	Clear	Anti-Fog	1/Bag	200 NEW!

sellstrom®



S81000



S81200



S81210E



S81220



S81220X

sellstrom®



S81310



S81320



S81330



S83000



S83200

GOGGLES – ADVANTAGE SERIES

813 Direct Vent Safety Goggles (Padded)

*
GOOD

- Direct vent series
- Provides maximum air flow and protection against flying debris
- Features padded face seal for maximum safety

PRODUCT NO.	Body Color	Vent Type	Lens	Coatings	Packaged	Case Qty.
S81310	Clear	Direct	Clear	Anti-Fog	1/Bag	200

813 Indirect Vent Chemical Splash Safety Goggle (Padded)

- Indirect vent chemical splash model
- Protects against liquid, dust, smoke, and chemical splash environments
- Features padded face seal for maximum safety

PRODUCT NO.	Body Color	Vent Type	Lens	Coatings	Packaged	Case Qty.
S81320	Clear	Indirect	Clear	Anti-Fog	1/Bag	200

813 Non-Vented Safety Goggles (Padded)

- Non-vented goggle
- Offers best protection from liquids and dust particles
- Features padded face seal for maximum safety

PRODUCT NO.	Body Color	Vent Type	Lens	Coatings	Packaged	Case Qty.
S81330	Clear	Non-Vent	Clear	Anti-Fog	1/Bag	200

830 Direct Vent "Mini" Safety Goggles

- Direct vent series
- Provides maximum air flow and protection against flying debris
- Mini version for children, students, and small faces

PRODUCT NO.	Body Color	Vent Type	Lens	Coatings	Packaged	Case Qty.
S83000	Green	Direct	Clear	Uncoated	1/Bag	200
S83010	Green	Direct	Clear	Anti-Fog	1/Bag	200

832 Indirect Vent "Mini" Chemical Splash Safety Goggles

- Indirect vent chemical splash series
- Protects against liquid, dust, smoke, and chemical splash environments
- Mini version for children, students, and small faces

PRODUCT NO.	Body Color	Vent Type	Lens	Coatings	Packaged	Case Qty.
S83200	Green	Indirect	Clear	Uncoated	1/Bag	100
S83210	Green	Indirect	Clear	Anti-Fog	1/Bag	200

GOGGLES – WELDING

Sellstrom carries one of the widest ranges of welding goggles in the industry

- All goggles feature soft, flexible green PVC bodies for excellent comfort and fit
- Top and bottom indirect vents provide superior ventilation and a safe, fog-free working environment (except S85150 eye cup goggle)
- Indirect vents provide superior protection against dust and chemical splashes
- Meets **ANSI Z87.1+ high impact** standards
- Models S80210, S85150, S85250, S85550 **CSA certified to CAN/CSA Z94.3** standards

BEST

Odyssey II Series Shade 5 Cutting Goggle

PRODUCT NO.	Body Color	Vent Type	Lens	Coatings	Tint	Case Qty.
S80210	Black (high temp)	Indirect	Single	Uncoated	Shade 5 IR**	100

sellstrom®



S80210

Plate Goggle

- Features standard size 2" x 4-1/4" Shade 5 IR fixed plate window
- Window includes filter, cover, and impact

**
BETTER

PRODUCT NO.	Body Color	Vent Type	Lens	Coatings	Case Qty.
S85450	Green	Indirect	Shade 5 IR	Uncoated	120



S85450

Lift Front Plate Goggle

- Features standard size 2" x 4-1/4" lift front plate window
- It's easy and safe — by keeping the welding goggle on at all times, the operator can flip the shaded window up or down, providing uninterrupted eye protection during cutting and grinding operations
- Clear lens provides eye protection when the flip plate is in the up position
- Flip windows available in two shades: 5 IR and Shade 6 Cobalt Blue
- Window includes filter, cover, and impact plates

**
BETTER

PRODUCT NO.	Body Color	Vent Type	Lens	Coatings	Case Qty.
S85550	Green	Indirect	Shade 5 IR	Uncoated	100
S85560B	Green	Indirect	Shade 6 Cobalt Blue	Uncoated	100



S85550

Lens Cover Goggle

- Features 50mm eye-cup style fixed plate windows with soft PVC body

**
BETTER

PRODUCT NO.	Body Color	Vent Type	Lens	Coatings	Case Qty.
S85250	Green	Indirect	Shade 5 IR	Uncoated	100



S85250

Lift Front Lens Cover Goggle

- Features 50mm eye-cup style lift front eye-cup windows with soft PVC body
- It's easy and safe — by keeping the welding goggle on at all times, the operator can easily flip the shaded windows up or down as required providing uninterrupted eye protection during cutting and grinding operations
- Clear lenses provide eye protection when the flip plate is in the up position

*
GOOD

PRODUCT NO.	Body Color	Vent Type	Lens	Coatings	Case Qty.
S85350	Green	Indirect	Shade 5 IR	Uncoated	100



S85350

Eye Cup Goggle

- Our most basic welding type goggle
- Features 50mm eye-cup lenses and two individual cup bodies
- Ideal for confined space

*
GOOD

PRODUCT NO.	Body Color	Vent Type	Lens	Coatings	Case Qty.
S85110	Green	Non-Vent	Clear	Uncoated	100
S85150	Green	Non-Vent	Shade 5 IR	Uncoated	100



S85150

sellstrom®

GERMICIDAL CABINETS

EXCLUSIVE!**MADE IN
USA**

Easily Adjusts for Face Shield OR Eyewear Use

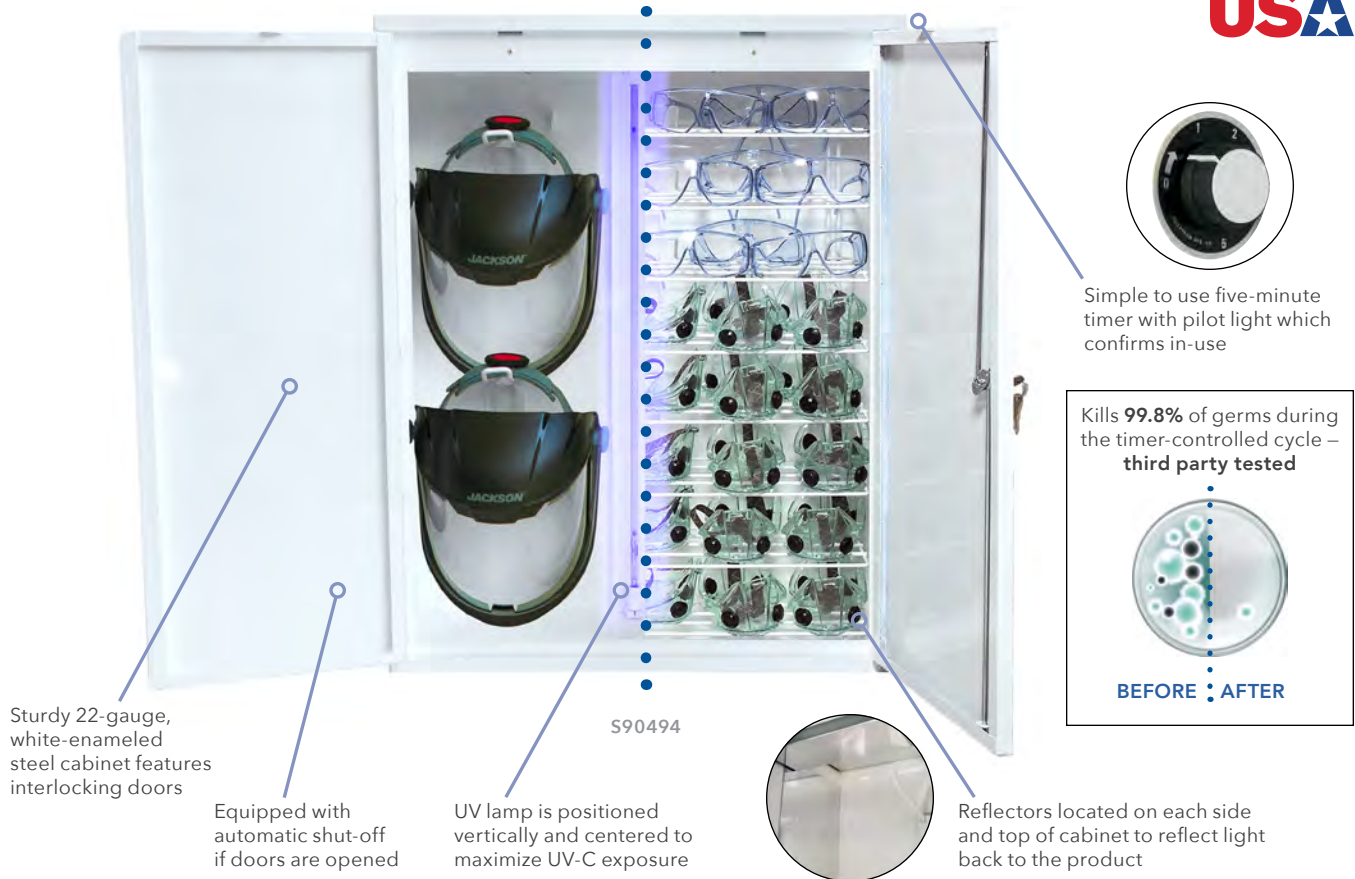

Sturdy 22-gauge, white-enameled steel cabinet features interlocking doors

Equipped with automatic shut-off if doors are opened

UV lamp is positioned vertically and centered to maximize UV-C exposure

S90494

Reflectors located on each side and top of cabinet to reflect light back to the product

Simple to use five-minute timer with pilot light which confirms in-use

Kills **99.8%** of germs during the timer-controlled cycle – **third party tested**



BEFORE AFTER

GERMICIDAL CABINETS

Why choose Sellstrom?

Sellstrom's Monitor® 2000 is proudly made in the USA and is the industry leader in UV-C germicidal cabinets. The Monitor® 2000 is underwriters laboratory listed and third-party tested* to eradicate up to 99.8% of germs, bacteria, and fungus on goggles, face shields, protective eyewear, and even sweatbands within five minutes.

Why UV-C sanitizing?

Traditional disinfection methods have been used for centuries – but are they good enough? The truth is that even the most rigorous cleaning with hot water, bleach, and disinfectants can miss harmful germs, bacteria, and mold. Ultraviolet germicidal irradiation (UVGI) is an affordable, environmentally friendly, and nontoxic method of sterilization. UVGI works by breaking down certain chemical bonds and scrambling the structure of DNA, RNA, and proteins, effectively destroying all microorganisms.

*Geneva Laboratory JN20DI525



S90494

Monitor® Germicidal Cabinets

- **Made in the USA** — Sellstrom's Monitor Series Germicidal Cabinet has been the industry leader for decades
- Germicidal cabinets sanitize goggles/safety glasses for next use
- Kills 99.4% of germs during the timer controlled cycle in five minutes — **third party tested**
- Sanitizes eyewear surfaces from germs, bacteria, mold, and fungus contaminants
- Sturdy 22-gauge white enameled steel cabinet features interlocking doors
- Features tamper-resistant latches with two keys provided
- Multiple units are keyed alike
- Zero UV radiation escapes during use
- Equipped with automatic shut-off if doors are opened
- Pilot light confirms UV lamp is in use on the Monitor 2000
- Wall or shelf mountable and includes 7' (2.13m) grounded cord
- For indoor use only; temperature range 32° to 104° Fahrenheit

GERMICIDAL CABINETS

Monitor® 2000 Germicidal Cabinet

- The Monitor 2000 has been the top selling germicidal cabinet for decades
- Specially designed for educational and medical industry applications
- Larger 32"H x 24.5"W x 9.5"D format includes eight shelves total
- Each shelf holds approximately five goggles or six safety glasses
- Sanitizes goggles/safety glasses for next use in just five minutes, an industry best
- Underwriters Laboratory listed and **CUL certified**



PRODUCT NO.	Description	Use	Case Qty.
S90494	Monitor 2000 Germicidal Cabinet	Education/Medical Industries	1



S90494
(Goggles and safety glasses not included)

Monitor® Germicidal Cabinet Replacement Parts

PRODUCT NO.	Description	Fits
S90479	Keys for Monitor Cabinets (Set of Two)	Monitor 2000
S90482	Lamp	Monitor 2000
S90484	Interlock Switch	Monitor 2000
S90486	Timer Knob and Faceplate	Monitor 2000
S90488	Locking Rod Assembly (Lock and Two Keys)	Monitor 2000
S90496	Universal Rack (One Rack)	Monitor 2000

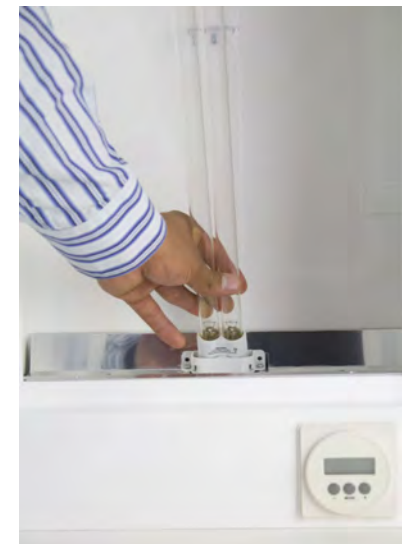

Optional Magnetic Hooks for Hanging Face Shields in Monitor Cabinet — NEW!

- Allows use of Monitor 2000 germicidal cabinet to sanitize face shields instead of glasses and goggles
- Set of four magnetic hooks allows sanitization of up to four face shields during the five-minute cycle time
- It's easy — simply remove the glasses and goggle rack from the Monitor 2000
- Space the four magnetic hooks in a pattern that allows up to four face shields to fit inside the cabinet
- Four magnetic brackets are designed to mount on the metal back wall of the cabinet
- Hang the face shields, close the door, set the timer, and after five minutes, away you go!
- Option expands the range of products that can be sanitized to include safety glasses, goggles, and now face shields
- The following Jackson and Sellstrom face shields have been tested and certified with the Monitor 2000 cabinet, effectively killing 99.4+% of germs:
 - Jackson Quad 500, Maxview, F4XP, MFS-320, 14955, 14957
 - Sellstrom 301, 303, 380, 390, and DP4 Series

PRODUCT NO.	Description	Pack Qty.
S90495	Magnetic Face Shield Mounting Hooks	4



Monitor 2000 shown with S90495 hooks





S23490
Box & Packets



S23480
Box & Tissues



S23469



S23470

STA-CLEAR™ LENS CLEANING PRODUCTS

- Cleans glass and polycarbonate safety glasses and goggle lenses
- Anti-static, anti-fog cleaning solution impregnated in tissues
- Scratch free — contains no silica
- Cleans without streaking or leaving static residue
- Not for fog-free (anti-fog coated) lenses

Sta-Clear™ Pre-Moistened Lens Cleaning Tissue Packets

- Convenient pre-moistened single use packets
- Towelette measures 5" x 8" (12.7 x 20.32cm)
- Convenient dispenser box contains 110 packets
- Can be wall mounted or placed on flat surface

PRODUCT NO.	Description	Packets/Box	Case Qty.
S23490	Pre-Moistened Non-Alcohol Based Towelettes	110	10/Box

Sta-Clear™ Lens Cleaning Tissues

- Tissues come dry and must be water activated
- Tissues measure 4.5" x 10.5" (11.43 x 27.31cm)
- Box measures 5.25" x 4.5" x 4" (13.02 x 12.07 x 11.75cm)
- Convenient dispenser box contains 1,000 tissues

PRODUCT NO.	Description	Tissues/Box	Case Qty.
S23480	Water Activated Lens Cleaning Tissue Box	1000	36/Box

Sta-Clear™ Lens Cleaning Stations

- Stations come with water activated tissues and 16 oz. pump spray bottle
- Tissues come dry and must be water activated
- Tissue measures 4.5" x 10.5" (11.43 x 27.31cm)
- Two variations available:
 - Cardboard station: Measures 8.625" x 6.5" x 5.375"
 - Metal station: Measures 8.75" x 6.5" x 5.25"
 - Metal station can be locked (uses key #23475)
- Opening allows for litter free disposal of used tissues
- Can be wall mounted or placed on flat surface

PRODUCT NO.	Description	Pack Qty.
S23469	Cardboard Station (1000 Tissues and Spray Bottle)	6/Box
S23470	Metal Station (1000 Tissues and Spray Bottle)	1/Box

EQUIPMENT CLEANING PRODUCTS

Sel-Kleen™ Pre-Moistened Equipment Cleaning Packets

- Anti-static, anti-fog cleaning solution impregnated in tissues
- Scratch free — contains no silica
- Alcohol-free pads use active ingredient benzalkonium chloride and will not harm even the most sensitive rubber or PVC material
- Convenient single use packets
- Towelette measures 5" x 8" (12.7 x 20.32cm)
- Convenient dispenser box contains 110 packets
- Can be wall mounted or placed on flat surface

PRODUCT NO.	Description	Packets/Box	Case Qty.
S22185	Pre-Moistened Non-Alcohol Based Towelettes	110	10/Box

sellstrom®



S22185
Box & Pack

SELLSTROM

EYEWEAR & EQUIPMENT
CLEANING PRODUCTS



sellstrom®

EXCLUSIVE!

Water flow is activated by pulling down yellow tray



Complies with ANSI Z358.1

Delivers 14 gallons of water over 15-minute period

Dual spray heads

S90320
16-Gallon Portable Eyewash Station

EMERGENCY EYEWASH

MADE IN USA

- The proper selection of emergency eyewash stations is critical when operating a safe working environment
- OSHA regulations listed in 29 CFR outline where and when eyewash equipment must be installed
- ANSI Z358.1 (Emergency Eyewash and Shower Equipment) is the standard that outlines the proper design, performance, and installation of emergency equipment to comply with the OSHA standard
- Sellstrom offers a wide range of emergency eyewash solutions, all of which are designed to meet the ANSI standards

EYEWASH STATIONS – PORTABLE EMERGENCY

Gravit-Eye 6-Gallon Portable (Personal) Gravity Feed Eyewash Station

- Six-gallon, gravity-flow personal portable eyewash station
- Ideal as a portable, first response eyewash solution
- Water stream is activated by removing the water retaining strap
- Water is fed through dual spray heads for maximum effectiveness
- 3' drain hose directs waste water into floor drain or storage tank
- Furnished with epoxy coated steel wall mounting bracket
- Can also be placed on flat surfaces such as counter tops
- Comes with 8 oz. bottle of bacteriostatic additive (S90322), which protects against growth of bacteria, fungus, algae and acanthamoeba
- Weight: 9.5 lbs. empty
- Complies with **ANSI Z358.1** for portable personal eyewash stations



S90306

PRODUCT NO.	Description	Case Qty.
S90306	6-Gallon Gravit-Eye Portable Personal Eyewash Station	1

EYEWASH STATIONS – PORTABLE EMERGENCY

Gravit-Eye 16-Gallon Portable Gravity Feed Eyewash Station

- 16-gallon, self-contained gravity-flow portable eyewash station
- Water is fed through dual spray heads for maximum effectiveness
- Delivers over 14 gallons (53 litres) of water over a 15-minute period
- Hi-vis green body is easily located in case of emergency
- Heavy wall construction with reinforced ribs ensures strength and durability
- Water flow is activated by pulling up (on) or down (off) on bright yellow tray
- Integrated full flow nozzle delivers gentle spray of water
- Waste water is directed through drain opening in tank basin
- 3' drain hose directs waste water into floor drain or storage tank
- Furnished with steel wall mounting bracket
- Can also be placed on flat surfaces such as counter tops
- Comes with 8 oz. bottle of bacteriostatic additive (S90322) which protects against growth of bacteria, fungus, algae and acanthamoeba
- Weight: 13 lbs. empty, 146 lbs. full
- Unit comes completely assembled
- Complies with **ANSI Z358.1** for portable eyewash stations

**MADE IN
USA**



S90320



S90335
Dust Cover Option

PRODUCT NO.	Description	Case Qty.
S90320	16-Gallon Gravit-Eye Portable Eyewash Station	1

PRODUCT NO.	Description	Fits
S90335	Dust Cover	S90320 16-Gallon Eyewash Station
S90321	3' Replacement Drain Hose	S90320 16-Gallon Eyewash Station
S90324	Replacement Mounting Bracket	S90320 16-Gallon Eyewash Station
S90325	Replacement Dispenser Cap	S90320 16-Gallon Eyewash Station
S90326	Replacement Manifold Assembly	S90320 16-Gallon Eyewash Station
S90336	Replacement Threaded Cap	S90320 16-Gallon Eyewash Station

15-Gallon Portable Pressurized Eyewash/Drench Hose Unit

- 15-gallon pressurized tank portable eyewash station
- Stainless steel tank comes with carrying handles, air intake fitting, pressure gauge and pressure relief valve
- Provides approximately 10 gallons (34 liters) of usable capacity
- Two gentle spray heads with flip top dust cover, internal flow control and filter
- Pressure regulator restricts flow to 0.65 GPM (approx. 15 minutes of flow)
- 1/2" IPS chrome plated brass stay-open ball valve with flag handle
- Drench hose contains a single gentle spray head with flip top dust cover, chrome plated brass squeeze valve, 6' reinforced PVC hose and stainless steel lever handle
- Weight: 35.6 lbs. empty, 119 lbs. full
- Unit comes completely assembled
- Complies with **ANSI Z358.1** for portable eyewash stations



S90315

PRODUCT NO.	Description	Case Qty.
S90315	15-Gallon Portable Pressurized Eyewash/Drench Hose Unit	1

Eyewash Bacteriostatic Additive – 8 oz.

- 8 oz. bottle of bacteriostatic additive
- For use in all makes of portable eyewash stations
- Protects against growth of bacteria, fungus, algae and acanthamoeba



S90322

PRODUCT NO.	Description	Case/Qty.
S90322	8 oz. Bottle of Bacteriostatic Formula	4/Case

sellstrom®



S90331



S90333



S90330/S90329

EYEWASH STATIONS – PORTABLE BOTTLES

Rapid-Clear Portable Eyewash Bottle Stations

- Personal eyewash bottle stations are extremely portable and handy
- Quickly flushes contaminants from eyes using a sterile, buffered and preserved saline solution
- The ideal first response solution when continuous water supply is not available
- Single or dual bottle stations available
- Date coded for easy inspection
- Tamper-evident seal with an easy-to-open twist off cap
- Highly visible green plastic backboard can be wall mounted or placed on flat surface
- FDA approved

PRODUCT NO.	Bottle Size	Type	Description	Case Qty.
S90331	16 oz.	Single	Rapid-Clear Eyewash Bottle Station	4/Case
S90332	32 oz.	Single	Rapid-Clear Eyewash Bottle Station	4/Case
S90333	32 oz.	Double	Rapid-Clear Eyewash Bottle Station	4/Case

Rapid Clear Replacement Eyewash Bottle Parts

- Replacement bottles with sterile saline solution
- Date coded for easy inspection
- Tamper-evident seal with an easy-to-open twist off cap
- FDA approved

PRODUCT NO.	Bottle Size	Description	Case Qty.
S90329	16 oz.	Rapid-Clear Replacement Eyewash Bottle	12/Case
S90330	32 oz.	Rapid-Clear Replacement Eyewash Bottle	12/Case

sellstrom

HEARING PROTECTION

SOME SOUND ADVICE



20774



67212



67220



523410



523403

HEARING PROTECTION

What You Should Know About Hearing Protection!

- Exposure to continuous high noise levels causes irreversible hearing loss
- Developing an effective workplace hearing safety program is critical
- OSHA sets the permissible eight-hour work day noise exposure level at 90 dBA and only two hours of exposure to 100 dBA
- Many companies place noise level limits even lower than the OSHA standard
- Here are guidelines that some companies apply for increased safety
 - 8 hours exposure = 85 dBA
 - 4 hours exposure = 88 dBA
 - 2 hours exposure = 91 dBA
 - 1 hour exposure = 94 dBA

About NRR Ratings and Their Practical Application in the Field

- The NRR ratings found on many hearing protection products in the market, including Jackson and Sellstrom, have been tested and certified in controlled laboratories
- However, working environments are seldom controlled environments
- In the field, hearing protection is not always fitted properly, leading to noise creep and the potential for hearing damage
- As a precaution, NIOSH recommends the following deratings during field use:
 - Ear Muffs — NIOSH recommends derating NRR ratings by 25%
 - Earplugs — NIOSH recommends derating NRR ratings by 50–75%
- In some applications, to achieve maximum protection, the use of earplugs and muffs together may be the safest solution. It is estimated that by combining the two, an extra 5 dBs can be added to the overall tested NRR rating

What Level of Protection Do You Need?

All hearing protectors sold by Jackson Safety and Sellstrom are tested to the American National Standards Institute (ANSI) S3.19-1974 Standard to receive a Noise Reduction Rating (NRR), which is labeled on all such products as required by the U.S. Environmental Protection Agency (EPA).

This number gives the consumer a method to judge performance among different models of hearing protectors – a higher NRR indicating more effective protection against sound. Some models of hearing protectors have multiple NRR numbers. This reflects the fact that these hearing protectors may be worn with their headbands in different positions.

Hearing Loss is Forever — Take Prevention Seriously!

Hearing protection should be taken very seriously and protectors, either muffs or plugs, should be comfortable to wear and offer sufficient attenuation to prevent hearing loss based on individual protection needed.

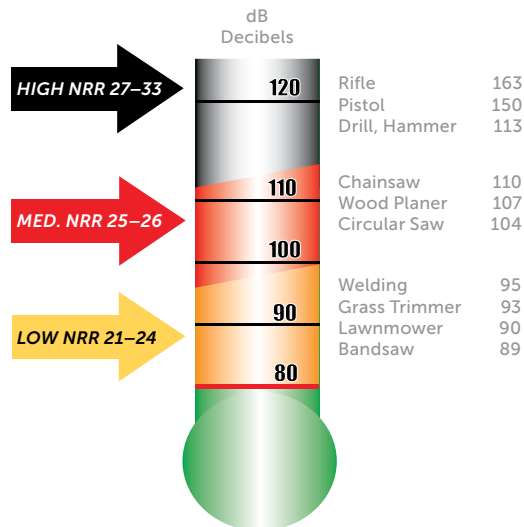

EARPLUGS – PREMIUM DISPOSABLE

Disposable Earplugs – Bullet Shape

- Contoured bullet shape premium quality polyurethane earplugs
- Gently but quickly expands to fit ear canal — one size fits all!
- Soft, non-irritating PU foam for maximum comfort
- Available corded and uncorded
- Plugs are individually packed in pairs and sold:
 - Uncorded = 200 pairs in convenient dispenser box
 - Uncorded = 500 pairs in bulk bag (replacement plugs for dispenser)
 - Uncorded = 500 pairs in convenient see-through wall dispenser
 - Uncorded = 10 pairs in retail slide blister package
 - Corded = 100 pairs in convenient dispenser box
- **CSA Class AL**

PRODUCT NO.	Type	Shape	Color	NRR	Package	Case Qty.
S23410	Uncorded	Bullet	Hi-Vis Green	32	200 Pair Dispenser Box	10/Box
S23411	Uncorded	Bullet	Hi-Vis Green	32	500 Pair Bulk Pack	10/Packs
S23412	Corded	Bullet	Hi-Vis Green	32	100 Pair Dispenser Box	20/Box
S23413	Uncorded	Bullet	Hi-Vis Green	32	500 Pair In Wall Dispenser	8
S23414	Uncorded	Bullet	Hi-Vis Green	32	10 Pair in Retail Package	200/Pack

H10 DISPOSABLE EARPLUGS

H10 Disposable Earplugs – Bullet Shape

- Soft roll-down foam
- Smooth “bullet” shape for easy insertion
- High visibility for easy compliance monitoring
- Gravity feed display box

PRODUCT NO.	Description	NRR	Class	Case Count
67210	Uncorded	31	A(L)	200 Pairs/Box; 8 Boxes/Case
67212	Corded	31	A(L)	100 Pairs/Box; 8 Boxes/Case

H10 Disposable Earplugs Dispenser and Bulk Pack (500 Pairs)

Earplugs

- Featuring H10 uncorded disposable foam earplugs
- 500 pairs (or 1000 earplugs) packed in a polybag

Dispenser

- Wall mountable and desktop ready
- Easy, flip open for quick refill
- Clear globe helps to indicate when to refill
- Mounting template and hardware included

PRODUCT NO.	Description	NRR	Class	Case Count
25708	Uncorded	31	A(L)	500 Pairs/Bag; 4 Bags/Case
25709	Dispenser	N/A	N/A	1 Dispenser/Case

H10 Metal Detectable Disposable Earplugs

- Designed to deliver on performance and comfort and help you improve compliance
- Distinctive blue color for easy compliance monitoring
- Individual packaging for hygienic storage
- Universal size
- Metal embedded in the earplug for easy detection

PRODUCT NO.	Description	NRR	Class	Case Count
13821	Corded	31	A(L)	100 Pairs/Box; 8 Boxes/Case

sellstrom®



S23410



S23412



S23413



S23414

JACKSON®
SAFETY



67212



25709



13821

sellstrom®



S23420



S23421



Comes with convenient plastic case

S23422

JACKSON®

SAFETY



67220



13822

EARPLUGS — PREMIUM REUSABLE

Reusable Earplugs — Tapered

- Newly developed four-flange, tapered earplug ensures optimum ear canal coverage
- Firm push/pull post makes insertion and removal quick and easy
- One size fits all
- Reusable — can be washed and reused dozens of times
- Made with non-allergenic polymer materials
- Plugs are individually packed in pairs and sold:
 - Uncorded = 100 pair/box
 - Corded = 100 pair/box
 - Corded = 1 pair in see-through plastic storage case with belt clip
- Independently tested/certified to **NRR 27 (ANSI S3.19)**
- **CSA Class AL**



S23421

PRODUCT NO.	Type	Shape	Color	Package	Case Qty.
S23420	Uncorded	Tapered	Blue/Hi-Vis Green	100 Pair/Box	20/Box
S23421	Corded	Tapered	Blue/Hi-Vis Green	100 Pair/Box	20/Box
S23422	Corded	Tapered	Blue/Hi-Vis Green	1 Pair/Plastic Case	500

H2O REUSABLE TRIPLE FLANGE EARPLUGS

H2O Reusable Earplugs — Tapered

- One size fits all
- Ridged for a better grip with insertion and removal
- Soft TPE flanges for comfortable fit and seal

PRODUCT NO.	Description	NRR	Class	Case Count
67220	Uncorded	26	A(L)	100 Pairs/Box; 4 Boxes/Case
67221	Corded	26	A(L)	100 Pairs/Box; 4 Boxes/Case

H2O Metal Detectable Reusable Earplugs

- Designed to deliver on performance and comfort and help you improve compliance
- Distinctive blue color for easy compliance monitoring
- Individual packaging for hygienic storage
- Universal size
- Metal embedded in the earplug for easy detection

PRODUCT NO.	Description	NRR	Class	Case Count
13822	Corded	26	A(L)	100 Pairs/Box; 4 Boxes/Case

EARPLUGS – PREMIUM BANDED

Banded Earplugs

- Banded earplugs are designed to wear around the neck when not in use
- Ensures workers always have quality hearing protection when required
- Ideal for regular and intermittent applications — easily installed or removed
- Compliance enforcement is made easy due to the hi-vis green band
- Specially designed band shape is curved at the plug end — keeps the ear pods up and away from dirty and contaminated surfaces when not in use
- Comfortable blue earplugs/pods are easily replaced when dirty (S23431)
- Used extensively on construction work sites, at airports and race tracks, in factory and shop applications, and wherever reusable ear protection is required
- Independently tested/certified to **NRR 25 (ANSI S3.19)**
- **CSA Class AL**

PRODUCT NO.	Type	Shape	Color	Package	Case Qty.
S23430	Banded	Tapered	Hi-Vis Green	1/Bag	320
S23431		Replacement Blue Plugs/Pods (Pair)		10 Pair/Bag	2,400



sellstrom®



S23430



S23431

67221 shown

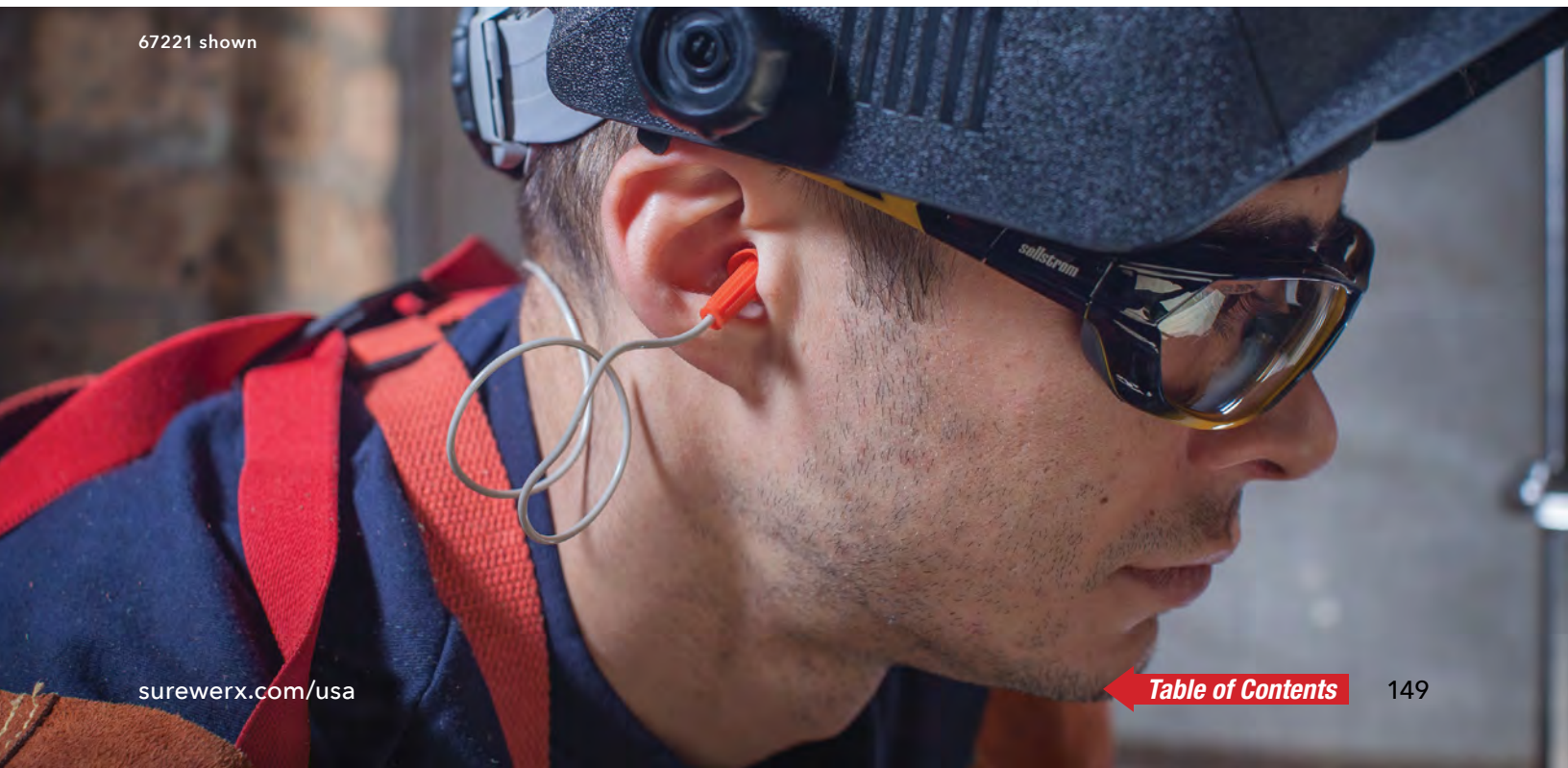



EAR MUFFS – SUPER PREMIUM DIELECTRIC



20774



20775

H70 Vibe® Premium Dielectric Ear Muff

***** BEST**

- Jackson's exclusive H70 Vibe® ear muffs offer premium comfort, fit, and protection
- Stylish, modern lightweight design
- Dielectric durable thermoplastic material protects you from electric shocks and shorts
- Headband, swivel fork arms, and cup pads have been carefully designed to deliver strength, durability, consistent noise reduction, and most importantly, to offer a comfortable snug fit with minimal pressure for all-day comfort
- Cup pads are super soft and comfortable — ideal for extended use
- Easily adjustable for quick and convenient positioning
- Features soft foam headband padding for maximum operator comfort and style
- Independently tested/certified to **ANSI S3.19**
- Available in both banded and hard hat cap mount format for use with slotted hard hats such as Jackson's SC-6
- Available in three popular NRR ratings
- Comes in four-color box with integrated fold-out hang tag
- **CE certified**

Vibe Headband Style

PRODUCT NO.	Old Code	Cup Color	Headband	NRR Rating	Pkg. Qty.	Case Qty.
20773	3015087	Orange	Comfort Foam	23	1/Pack	20/Packs
20774	3015089	Red	Comfort Foam	26	1/Pack	20/Packs
20775	3015090	Black	Comfort Foam	29	1/Pack	20/Packs

Vibe Cap Mount Style

PRODUCT NO.	Old Code	Cup Color	Mount	NRR Rating	Pkg. Qty.	Case Qty.
20776	3015091	Orange	Cap Mount	22	1/Pack	20/Packs
20777	3015092	Red	Cap Mount	25	1/Pack	20/Packs
20778	3015093	Black	Cap Mount	27	1/Pack	20/Packs

EAR MUFFS — PREMIUM DIELECTRIC

HPD425 Premium Dielectric Ear Muff

- HPD425 ear muffs offer premium features and protection
- Stylish, modern lightweight design
- Dielectric — protects you from electric shocks and shorts
- Hi-vis green/black cups are highly visible even in low light conditions
- Cup pads are soft and comfortable — ideal for extended use
- Heavy-duty non-conductive swivel fork arms ensure strength & durability
- Easily adjustable for quick and convenient positioning
- Features soft foam head band for maximum operator comfort and style
- Independently tested/certified to **NRR 25 (ANSI S3.19)**
- **CSA Class A**



PRODUCT NO.	Cup Color	Headband	NRR Rating	Pkg. Qty	Case Qty.
S23407	Hi-Vis Green/Black	Soft EVA Foam	25 dB	10/Box	40

EAR MUFFS — PREMIUM SERIES

- Sellstrom introduces a full range of ear muffs offering premium features
- Stylish, modern lightweight design
- Cup pads are soft and comfortable — ideal for extended use
- Strong stainless steel wire swivel fork arms ensure strength & durability
- Easily adjustable for quick and convenient positioning
- Feature soft EVA head bands for maximum operator comfort and style

HP431 Premium Ear Muff

- The HP431 ear muff offers our highest NRR rating (31 dB)
- Ideal for work in very high noise environments
- Independently tested/certified to **NRR 31 (ANSI S3.19)**
- **CSA Class A**



PRODUCT NO.	Cup Color	Headband	NRR Rating	Pkg. Qty	Case Qty.
S23406	Black/Red	Soft EVA Foam	31 dB	10/Box	60

HP427 Premium Ear Muff

- Our most popular premium series ear muff
- Low profile "slim" design is ultra-lightweight and comfortable
- Folds into a very compact, easy-to-store size
- Independently tested/certified to **NRR 27 (ANSI S3.19)**
- **CSA Class AL**



PRODUCT NO.	Cup Color	Headband	NRR Rating	Pkg. Qty	Case Qty.
S23404	Black/Orange	Soft EVA Foam	27 dB	10/Box	60

HP424 Premium Ear Muff

- Low profile "slim" design is ultra-lightweight and comfortable
- Folds into a very compact, easy-to-store size
- Independently tested/certified to **NRR 24 (ANSI S3.19)**
- **CSA Class A**



PRODUCT NO.	Cup Color	Headband	NRR Rating	Pkg. Qty	Case Qty.
S23403	Black	Soft EVA Foam	24 dB	10/Box	40

sellstrom®



S23407

Soft EVA foam headband



S23406

Soft EVA foam headband



S23404

Soft EVA foam headband



S23403

sellstrom®



S23400



S23401

JACKSON®

SAFETY



20771

EAR MUFFS — ADVANTAGE SERIES

- Sellstrom carries two Advantage Series ear muffs
- Comfortable, lightweight, and economically priced
- Dielectric — protects you from electric shocks and shorts
- Cup pads are soft and comfortable — ideal for extended use
- Tough, long-lasting tension bands
- Easily adjustable for quick and convenient positioning

Tonedown 200 Ear Muffs

- Our highest NRR rated economy ear muff (26 dB)
- Bright safety color yellow cups
- Independently tested/certified to **NRR 26 (ANSI S3.19)**

*
GOOD

PRODUCT NO.	Cup Color	Headband	NRR Rating	Case Qty.
S23400	Yellow	Curved Plastic	26 dB	40/Box

H225 Ear Muffs

- Our most popular and economically priced ear muff
- Attractive blue cups
- Comes in convenient clamshell package for display purposes
- Independently tested/certified to **NRR 25 (ANSI S3.19)**
- **CSA Class A**

*
GOOD

PRODUCT NO.	Cup Color	Headband	NRR Rating	Pkg. Qty.	Case Qty.
S23401	Blue	Curved Plastic	25 dB	10/Box	60

H70 PASSIVE EAR MUFFS

H70 Onyx® Ear Muffs

- Lightweight, durable, and economical protection for low- to medium-level noise environments
- Ultra-soft ear cushions for comfort and extended wear
- Ball-and-socket pivoting cup attachment provides optimum pressure distribution
- Header bag packaging
- Earmuff is dielectric with no exposed metal parts

*
GOOD

PRODUCT NO.	Old Code	Description	NRR Rating	Case Count
20771	3015085	Headband Style	23 dB	1/Pack
20772	3015086	Headband Style	26 dB	1/Pack

EAR MUFFS — SUPER PREMIUM CAP MOUNTED

EXCLUSIVE!

H70 Vibe® Ear Muffs — Super Premium Capmount

BEST**

- Innovative design that adjusts to fit most head shapes and sizes
- Dielectric, durable thermoplastic material retains shape and pressure for consistent noise reduction
- Various noise level reductions available in capmount styles
- Exclusive Jackson Safety® designs
- Extreme comfort and fit
- Comes in four-color display box

PRODUCT NO.	Old Code	Description	NRR Rating	Case Count	Master Carton Qty.
20776	3015091	Capmount, Orange	22	1/Pack	20/Pack
20777	3015092	Capmount, Red	25	1/Pack	20/Pack
20778	3015093	Capmount, Black	27	1/Pack	20/Pack



20776
(Hard hat and face shield not included)

EAR MUFFS — PREMIUM CAP MOUNTED

HPS428 Premium Cap Mounted Ear Muffs

BETTER**

- Designed to mount on to most brands of slotted hard hats
- Cup pads are soft and comfortable — ideal for extended use
- Strong stainless steel wire swivel fork arms ensure strength and durability
- Easily adjustable for quick and convenient positioning
- One of the highest NRR ratings for a cap-mounted muff (28 dB)
- Independently tested/certified to **NRR 28 (ANSI S3.19)**
- **CSA Class A**

PRODUCT NO.	Cup Color	Head Band	NRR Rating	Pkg. Qty	Case Qty.
S23409	Black/Red	Soft EVA Foam	28 dB	10/Box	60

JACKSON
SAFETY



20776



20777



20778

sellstrom



S23409
(Hard hat not included)

HEAD PROTECTION

**WORKING SAFE
MAKES SENSE**

Jackson Safety® Hard Hat Portfolio

 NEW!	 NEW!	 MADE IN USA	 MADE IN USA
CH-300	CH-400V	C10	C10 c/w Adaptor
 NEW!	 MADE IN USA	 MADE IN USA	 MADE IN USA
Advantage Cap Style	Charger® Cap Style	Sentry III® Cap Style	SC-6 Cap Style
 NEW!	 MADE IN USA	 NEW!	 MADE IN USA
Advantage Full Brim	Blockhead II	Blockhead FG	Western Outlaw®

Hard hat customization now available on fully automated equipment.

Types & Class Standards

Protective hard hats are classified according to the specific impact and electrical performance requirements they are designed to meet. All protective hard hats in accordance with this standard shall meet Type I impact requirements. In addition, all hard hats are further classified as meeting Class C, Class G, or Class E electrical requirements.

Impact Types

Type I: Hard hats intended to reduce the force of impact resulting from a blow only to the top of the head.

Type II: Hard hats intended to reduce the force of impact resulting from a blow which may receive limited protection odd center, lateral, or to the top of the head.

Electrical Classes

Class C (Conductive): Class C hard hats are not intended to provide protection against contact with electrical conductors.

Class G (General): Class G hard hats are intended to reduce the danger of contact exposure to low-voltage conductors. Test samples are proof-tested at 2,200 volts (phase to ground). However, this voltage is not as an indication of the voltage at which the hard hat protects the wearer.

Class E (Electrical): Class E hard hats are intended to reduce the danger of exposure to higher-voltage conductors. Test samples are proof-tested at 20,000 volts (phase to ground). However, this voltage is not intended as an indication of the voltage at which the hard hat protects the wearer.

Optional Standards



Reverse Donning: Reverse-wearing option hard hats must pass force transmission requirements whether they are worn facing forward or backwards in accordance with the manufacturer's wearing instructions.



HEAD PROTECTION – CLIMBING STYLE INDUSTRIAL HARD



NEW!
COMING SOON!

CH HARD HATS – INDUSTRIAL "CLIMBING" STYLE



CH-400V "Climbing Inspired" Industrial Hard Hat – Vented



- Introducing Jackson's new ultra-modern "climbing inspired" industrial hard hat
- Lightweight, molded from high-quality ABS materials
- Unique sliding vent hole system allows operator to open vents when working in direct sun/hot dry climates — or closed when used in cold or rainy conditions
- Super comfortable 6 pt. ratcheting suspension fits head sizes 6-1/2 to 8
- Rapid-Dial ratcheting headgear — just grab and adjust, even with gloves on
- Comfortable and convenient chin strap with molded chin cup for added security
- Comfortable, replaceable sweatband
- More comfortable than "traditional" hard hats
- Four external clips are strategically positioned to securely fasten elastic straps found on LED lighting systems
- Slotted adapters allow use with multiple Jackson and Sellstrom hard hat accessories including face shield adapters, ear muffs and Safe 2 System
- Multiple accessories available, including ear muffs and face shield adaptor systems
- Dual rear slots allow use of optional red reflector for improved safety
- Hi-vis reflective tape kit available for added safety
- Ideal for at-height and scaffolding work, confined space applications, construction sites requiring chin straps, and general all-around head protection
- Meets ANSI Z89.1, Type 1, Class C

PRODUCT NO.	Color	Suspension	Case Count
20920	White	6 pt. Rapid Dial	20
20921	Yellow	6 pt. Rapid Dial	20
20923	Orange	6 pt. Rapid Dial	20
20926	Hi-Vis Green	6 pt. Rapid Dial	20
20927	Black	6 pt. Rapid Dial	20

HEAD PROTECTION – CLIMBING STYLE INDUSTRIAL HARD

CH-300 “Climbing-Inspired” Industrial Hard Hat – Non-Vented

- Introducing Jackson’s new ultra-modern “Climbing-Inspired” industrial hard hat
- Lightweight, molded from high density polyethylene (HDPE)
- Super comfortable 6 pt. ratcheting suspension fits head sizes 6-1/2 to 8
- Rapid-Dial ratcheting headgear — just grab and adjust, even with gloves on
- Comfortable and convenient chin strap with molded chin cup for added security
- Comfortable, replaceable sweatband
- More comfortable than “traditional” hard hats
- Four external clips are strategically positioned to securely fasten elastic straps found on LED lighting systems
- Slotted adapters allow use with multiple Jackson and Sellstrom hard hat accessories including face shield adapters, ear muffs, and Safe 2 System
- Hi-vis reflective tape kit available for added safety
- Ideal for at-height and scaffolding work, confined space applications, construction sites requiring chin straps, and general all-around head protection
- Meets ANSI Z89.1, Type 1, Class C, G, E, and EN397 European Standards

NEW!

COMING SOON!



JACKSON
SAFETY

JACKSON SAFETY

HEAD PROTECTION



16797

Face shield and ear muffs sold separately



16150



16250



20937

(Hard hat sold separately)



Capmount H70 Ear Muff 20776, 20777, 20778
(Hard hat and ear muffs sold separately)



20933

PRODUCT NO.	Color	Suspension	Case Count
20900	White	6 pt. Rapid Dial	20
20901	Yellow	6 pt. Rapid Dial	20
20903	Orange	6 pt. Rapid Dial	20
20906	Hi-Vis Green	6 pt. Rapid Dial	20
20907	Black	6 pt. Rapid Dial	20

REPLACEMENT PARTS & ACCESSORIES	Description	Case Count
20930	Replacement Ratcheting Headgear (CH-300 and CH-400V)	20
20933	CH-300/CH-400V Cap Adapter with Universal Pin Pattern Window Mounting System	20
20931	Replaceable Sweatbands	20/Pack
20932	Replacement Chin Strap for CH-300 and CH-400V	1/Pack
16797	Safe 2 Face Shield/Ear Muff Bracket (only)	1/Pack
16150	JLHL-150 150 Lumen COB 3-Function IP54 Swivel Headlamp	12
16250	JUHL-250 250 Lumen SMD/COB 4-Function USB IP54 Headlamp	24
20936	Red Reflector (Mounts to CH-400V Dual Rear Slots)	1/Pack
20937	Hi-Vis Reflective Tape Kit for any Hard Hat Model	1/Pack



HEAD PROTECTION — FULL BRIM HARD HATS

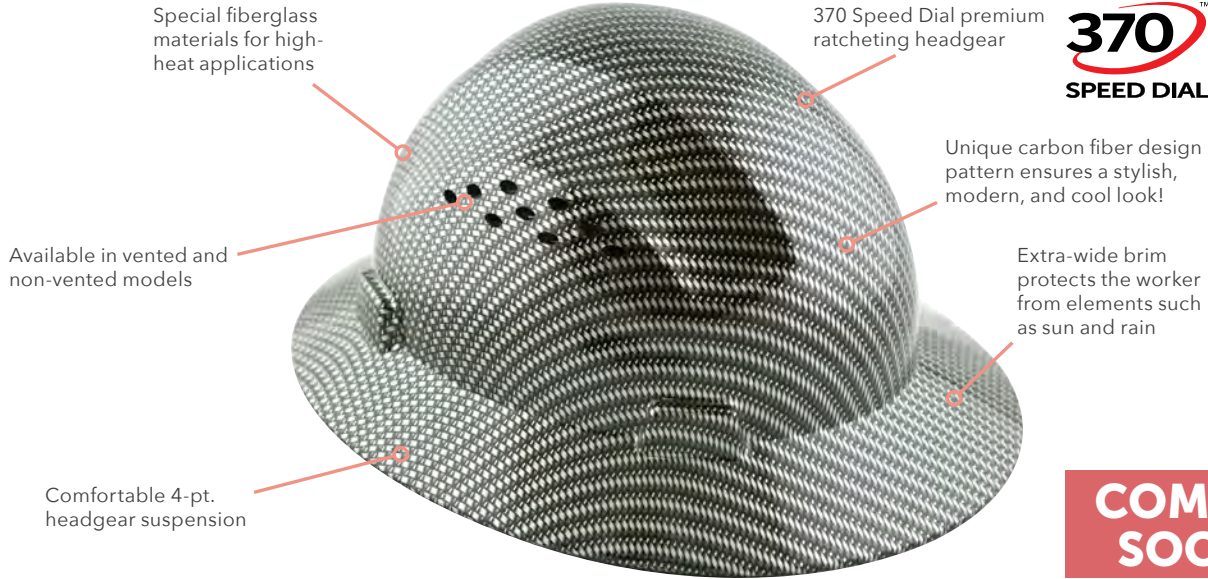

COMING SOON!
NEW!

BLOCKHEAD® FG — PREMIUM FIBERGLASS FULL-BRIM HARD HATS



Blockhead FG Fiberglass Full Brim Hard Hat — Non-Vented

- Contoured dome shape with modern stylish ridgeline for unique identification
- Wrap-around brim further protects the worker from elements such as sun and rain
- Molded from special fiberglass materials — great for general and high heat applications
- **Features Jackson's 370 Speed Dial ratcheting headgear** — an industry best!
- 4 pt. ratchet suspension fits head sizes 6-1/2 to 8
- Comfortable, replaceable sweatband
- Wrapped using a special water transfer decal to portray a stylish "composite" look
- A premium wide brim hard hat
- Meets **ANSI Z89.1, Class C, G, and E**



PRODUCT NO.	Color	Suspension	Case Count
20600	Composite Wrap	4 pt. 370 Speed Dial	20



Chin strap sold separately

Blockhead FG Fiberglass Full Brim Hard Hat — Vented

- Same great features as non-vented version, but features vent holes to reduce heat build-up when working in direct sun and hot climates
- Vent holes reduce heat build-up when working in direct sun, hot climates and high-heat applications such as foundry and steel mill work environments
- Meets **ANSI Z89.1, Class C**

PRODUCT NO.	Color	Suspension	Case Count
20620	Composite Wrap	4 pt. 370 Speed Dial	20



REPLACEMENT PARTS	Description	Case Count
20630	Replacement Ratcheting Headgear (Blockhead FG Series)	12
20931	Replaceable Sweatbands	20/Pack
20832	Optional Chin Strap	1/Pack

HEAD PROTECTION — FULL BRIM HARD HATS

BEST

JACKSON
SAFETY

370
SPEED DIAL

370 Speed Dial premium ratcheting headgear

Super comfortable heavy-duty 8-pt. headgear suspension

Made in USA

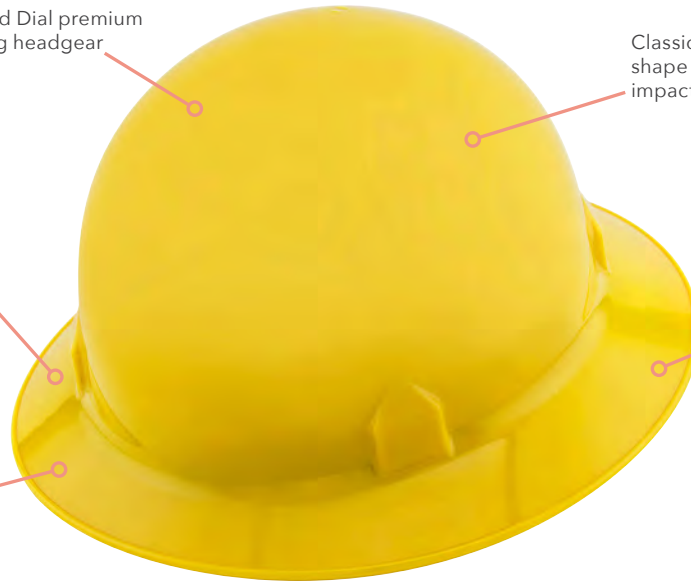

Classic smooth dome shape for improved impact deflection

Extra-wide brim protects the worker from elements such as sun and rain

BLOCKHEAD® — PREMIUM FULL-BRIM HARD HATS

COMING SOON!

Blockhead® Series Full Brim Hard Hat — Non-Vented

- Classic smooth dome shape for improved impact deflection
- Wrap-around brim further protects the worker from elements such as sun and rain
- Lightweight, molded in the USA from high density polyethylene (HDPE)
- Features Jackson's 370 Speed Dial ratcheting headgear — an industry best!
- Superior 6 pt. ratchet suspension — offers premium comfort and safety
- Fits head sizes 6-1/2 to 8
- Comfortable, replaceable sweatband
- Meets ANSI Z89.1, Class C, G, and E

MADE IN
USA

370
SPEED DIAL



370
SPEED DIAL

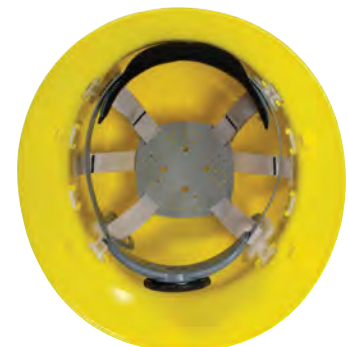

6 pt. suspension

PRODUCT NO.	Color	Suspension	Case Count
20697	White	6 pt. 370 Speed Dial	10
20698	Yellow	6 pt. 370 Speed Dial	10
20699	Blue	6 pt. 370 Speed Dial	10
20701	Orange	6 pt. 370 Speed Dial	10
20702	Red	6 pt. 370 Speed Dial	10
20718	Green	6 pt. 370 Speed Dial	10
20738	Hi-Vis Orange	6 pt. 370 Speed Dial	10
REPLACEMENT PARTS	Old Code	Description	Case Count
20703	3014879	6 pt. Suspension	6
14429	3000105	Sweatband	12/Bag
14937	3002430	2 pt. Chin Strap	12/Bag



20802



20820



Chin strap sold separately

HEAD PROTECTION — FULL BRIM HARD HATS

COMING SOON!

* GOOD

NEW!

Advantage Series Full Brim Hard Hat — Non-Vented

- Contoured dome shape with modern stylish ridgeline for unique identification
- Wrap-around brim further protects the worker from elements such as sun and rain
- Lightweight, molded from high density polyethylene (HDPE)
- 4 pt. easy-dial ratchet suspension fits head sizes 6-1/2 to 8
- Comfortable, replaceable sweatband
- Our most economical full brim hard hat
- Meets ANSI Z89.1, Type 1, Class C, G, and E

PRODUCT NO.	Color	Suspension	Case Count
20800	White	4 pt. Rapid Dial	20
20801	Yellow	4 pt. Rapid Dial	20
20802	Blue	4 pt. Rapid Dial	20
20803	Orange	4 pt. Rapid Dial	20
20804	Red	4 pt. Rapid Dial	20
20805	Hi-Vis Orange	4 pt. Rapid Dial	20

Advantage Series Full Brim Hard Hat — Vented

- Same great features as non-vented version, but features vent holes to reduce heat build-up when working in direct sun and hot climates
- Meets ANSI Z89.1, Type 1, Class C

* GOOD

NEW!







PRODUCT NO.	Color	Suspension	Case Count
20820	White	4 pt. Rapid Dial	20
20821	Yellow	4 pt. Rapid Dial	20
20822	Blue	4 pt. Rapid Dial	20
20823	Orange	4 pt. Rapid Dial	20
20824	Red	4 pt. Rapid Dial	20
20825	Hi-Vis Orange	4 pt. Rapid Dial	20

REPLACEMENT PARTS	Description	Case Count
20230	Replacement Ratcheting Headgear (Advantage Series Front Brim and Full Brim)	20
20931	Replaceable Sweatband	20/Pack
20832	Optional Chin Strap	1/Pack

HEAD PROTECTION — CAP-STYLE SLOTTED HARD HATS







Advantage Series Cap-Style Slotted Hard Hat — Non-Vented

- Contoured dome shape with modern stylish ridgeline for unique identification
- Longer bill for improved protection from sun and falling debris
- Built-in rain trough helps shed water away from the neck
- Slotted adaptors allow use with multiple Jackson and Sellstrom hard hat accessories including face shield adaptors and Vibe ear muffs
- Lightweight, molded from high density polyethylene (HDPE)
- 4 pt. easy-dial ratchet suspension fits head sizes 6-1/2 to 8
- Comfortable, replaceable sweatband
- Our most economical cap style hard hat
- Meets **ANSI Z89.1, Type 1, Class C, G, and E**

PRODUCT NO.	Color	Suspension	Case Count
20200	 White	4 pt. Rapid Dial	20
20201	 Yellow	4 pt. Rapid Dial	20
20202	 Blue	4 pt. Rapid Dial	20
20203	 Orange	4 pt. Rapid Dial	20
20204	 Red	4 pt. Rapid Dial	20
20205	 Hi-Vis Orange	4 pt. Rapid Dial	20

Advantage Series Cap-Style Slotted Hard Hat — Vented

- Contoured dome shape with modern stylish ridgeline for unique identification
- Longer bill for improved protection from sun and falling debris
- Built-in rain trough helps shed water away from the neck
- Slotted adaptors allow use with multiple Jackson and Sellstrom hard hat accessories including face shield adaptors and Vibe ear muffs
- Lightweight, molded from high density polyethylene (HDPE)
- 4 pt. easy-dial ratchet suspension fits head sizes 6-1/2 to 8
- Comfortable, replaceable sweatband
- Our most economical cap style hard hat
- Vent holes reduce heat build-up when working in direct sun and hot climates
- Meets **ANSI Z89.1, Type 1, Class C**

PRODUCT NO.	Color	Suspension	Case Count
20220	 White	4 pt. Rapid Dial	20
20221	 Yellow	4 pt. Rapid Dial	20
20222	 Blue	4 pt. Rapid Dial	20
20223	 Orange	4 pt. Rapid Dial	20
20224	 Red	4 pt. Rapid Dial	20
20225	 Hi-Vis Orange	4 pt. Rapid Dial	20

REPLACEMENT PARTS	Description	Case Count
20230	Replacement Ratcheting Headgear (Advantage Series Front Brim and Full Brim)	20
20931	Replaceable Sweatband	20/Pack
20832	Optional Chin Strap	1/Pack

COMING SOON!

* GOOD

NEW!



JACKSON
SAFETY



20201



Chin strap sold separately

* GOOD

NEW!



20220



Chin strap sold separately

JACKSON
SAFETY

370
SPEED DIAL

Premium 370 Speed Dial™ ratcheting headgear

Slotted cap allows use with dozens of Jackson hard hat accessories including our exclusive Hard Hat Interchange System

Longer bill for improved protection from sun and falling debris

HEAD PROTECTION — CAP-STYLE SLOTTED HARD HATS

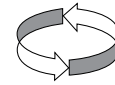

Reverse donning rated

BEST

Smooth dome shape for improved impact deflection

Comfortable 4-pt. suspension



SC-6 Hard Hat works with the Hard Hat Interchange System



SC-6 — PREMIUM CAP-STYLE HARD HAT



14833



SC-6 Cap-Style Slotted Hard Hat — Non-Vented

- Classic smooth dome shape for improved impact deflection
- Longer bill for improved protection from sun and falling debris
- Slotted adaptors allow use with multiple Jackson and Sellstrom hard hat accessories including face shield adaptors and ear muffs
- Lightweight, molded in the **USA** from high density polyethylene (HDPE)
- Meets reverse donning standards
- 4 pt. ratchet suspension fits head sizes 6-1/2 to 8
- Features Jackson's **370 Speed Dial** ratcheting headgear — an industry best!
- Comfortable, replaceable sweatband
- Our most popular hard hat!
- Meets **ANSI Z89.1, Type 1, Class C, G, and E**
- **CSA certified to CSA Z94.1, Type 1, Class E**

MADE IN USA

370
SPEED DIAL

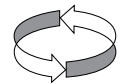

Reverse donning

PRODUCT NO.	Old Code	Color	Suspension	Case Count
14833	3001987	Yellow	4 pt. 370 Speed Dial	12
14834	3001988	White	4 pt. 370 Speed Dial	12
14836	3001989	Brown	4 pt. 370 Speed Dial	12
14839	3001990	Green	4 pt. 370 Speed Dial	12
14838	3001991	Blue	4 pt. 370 Speed Dial	12
14839	3001992	Orange	4 pt. 370 Speed Dial	12
14841	3001993	Red	4 pt. 370 Speed Dial	12
14842	3001994	Gray	4 pt. 370 Speed Dial	12
14843	3001996	Hi-Vis Orange	4 pt. 370 Speed Dial	12
REPLACEMENT PARTS	Description		Case Count	
14936	3002428	4-pt. Suspension	6	
14937	3002430	2-pt. Chin Strap	12/Bag	
14958	3002459	Sweatband	25/Bag	





14409



6 pt. Ratchet Suspension

HEAD PROTECTION — CAP-STYLE SLOTTED HARD HATS

Sentry III® Cap-Style Slotted Hard Hat — Non-Vented

- Low profile, silhouette-styled hard hat
- Longer bill for improved protection from sun and falling debris
- Flat, customizable front area
- Low riding nape strap
- Slotted adaptors allow use with multiple Jackson and Sellstrom hard hat accessories including face shield adaptors and ear muffs
- Lightweight, molded in the USA from high density polyethylene (HDPE)
- Meets reverse donning standards
- 6 pt. ratchet suspension fits head sizes 6-1/2 to 8
- Comfortable, replaceable sweatband
- Meets ANSI Z89.1, Type 1, Class C, G, and E

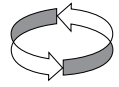

Reverse donning



PRODUCT NO.	Old Code	Color	Suspension	Case Count
14407	3000061	Yellow	6 pt. Ratcheting	12
14409	3000064	White	6 pt. Ratcheting	12
14416	3000072	Blue	6 pt. Ratcheting	12
14418	3000075	Red	6 pt. Ratcheting	12
14420	3000078	Orange	6 pt. Ratcheting	12
14423	3000085	Hi-Vis Orange	6 pt. Ratcheting	12

REPLACEMENT PARTS	Description		
14426	3002428	6-pt. Suspension	6
14429	3002459	Sweatband	12/Bag
14434	3002430	2-pt. Chin Strap	25/Bag
18446	3009653	4-pt. Chin Strap	12/Bag





HEAD PROTECTION — CAP-STYLE SLOTTED HARD HATS

Charger® Cap-Style Slotted Hard Hat — Non-Vented

- Contoured dome shape with heavy ridgeline for unique identification
- Shorter bill for improved upward vision
- Built-in rain trough helps shed water away from the neck
- Slotted adaptors allow use with multiple Jackson and Sellstrom hard hat accessories including face shield adaptors & ear muffs
- Lightweight, molded in the **USA** from high density polyethylene (HDPE)
- Meets reverse donning standard
- 4 pt. ratchet suspension fits head sizes 6-1/2 to 8
- Comfortable, replaceable sweatband
- Meets **ANSI Z89.1, Type 1, Class C, G, and E**



Reverse donning

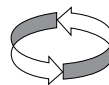

Built-in rain trough

20392

Shorter bill improves upward vision

PRODUCT NO.	Old Code	Color	Suspension	Case Count
20392	3013362	White	4 pt. Ratcheting	12
20393	3013363	Blue	4 pt. Ratcheting	12
20394	3013364	Red	4 pt. Ratcheting	12
20395	3013365	Hi-Vis Orange	4 pt. Ratcheting	12
20397	3013367	Gray	4 pt. Ratcheting	12
20398	3013368	Orange	4 pt. Ratcheting	12
20401	3013370	Yellow	4 pt. Ratcheting	12
20403	3013372	Neon Pink	4 pt. Ratcheting	12

REPLACEMENT PARTS	Description	Case Count
14429	Sweatband	12/Bag
14434	2-pt. Chin Strap	25/Bag
18446	4-pt. Chin Strap	12/Bag
20422	4-pt. Suspension	6



4 pt. Ratchet Suspension



(14809-14816)

It's as Easy as 1, 2, 3!

1
Order Jackson Safety's C10 bump cap with face shield adaptor (20186-20192)



2
Attach our new Jackson Safety 8" x 15.5" x .035" Shape E/N face shield window with **anti-fog** coating (28764)



3
You're safe to go with a complete bump cap, adaptor and **anti-fog** face shield kit!



HEAD PROTECTION – BUMP CAPS

Jackson Bump Caps, Adaptors, and Window Solutions



C10 Bump Cap Series (Bump Caps only)

- Bump caps are used to protect your head from minor bumps and scalp lacerations
- 4 pt. pin-lock suspension fits head sizes 6-1/2 to 8-1/4
- Features an absorbent brow pad for added comfort
- Can be customized with your company logo and branding needs
- **Please note:** To convert an existing bump cap for use with a face shield, use 14946 Jackson hard hat adaptor with 29107 8" x 15.5" x .035" PETG anti-fog window

PRODUCT NO.	Cap Color	Suspension	Case Qty.
14809	Yellow	Pinlock	12
14811	White	Pinlock	12
14812	Green	Pinlock	12
14813	Blue	Pinlock	12
14814	Orange	Pinlock	12
14815	Red	Pinlock	12
14816	Gray	Pinlock	12

C10 Bump Cap Series c/w Face Shield Attachment



- Same great features as above but includes an installed face shield adaptor
 - Exclusive attachment converts your bump cap into a cap/face shield combo
 - Uses Jackson windows:
 - **28764 8" x 15.5" x .035" clear PETG anti-fog window (Recommended)**
 - 28765 6" x 15.5" x .040" clear PETG window
 - Model #28765 does not meet ANSI Z87.1 standards due to coverage limitations
- Please note:** Windows sold separately

PRODUCT NO.	Cap Color	Suspension	Case Qty.
20186	White	Pinlock	12
20187	Yellow	Pinlock	12
20188	Blue	Pinlock	12
20189	Green	Pinlock	12
20191	Red	Pinlock	12
20192	Orange	Pinlock	12
20193	Gray	Pinlock	12

C10 Bump Cap Replacement Parts

PRODUCT NO.	Description	Case Qty.
20194	4 pt. Suspension	6
18428	Sweatband	12/Bag

Universal Fit Adaptor & Window

Did you know? Our Jackson Safety 14946 universal hard hat adaptor fits most bump caps on the market. Use this adaptor along with our new 29107 **anti-fog** window to quickly convert your bump cap into a bump cap/face shield system



14946

Universal fit hard hat/ bump cap adaptor – uses universal pin pattern window mounting system

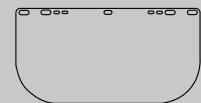

29107



8" x 15.5" x .035" PETG Shape E Anti-fog

HEAD PROTECTION — COWBOY HARD HAT

Western Outlaw® Hard Hat

- Popular cowboy-style hard hat offers unique style and image
- 4 pt. ratchet suspension fits head sizes 6-1/2 to 8
- Comfortable, replaceable sweatband
- Meets ANSI Z89.1, Type 1, Class C, G, and E

**MADE IN
USA**

PRODUCT NO.	Old Code	Color	Suspension	Case Count
17330	3007313	 Black	Ratcheting	4
19500	3010943	 White	Ratcheting	4
19502	3010944	 Tan	Ratcheting	4
REPLACEMENT PARTS		Description	Case Count	
14429	3000105	Sweatband	12/Bag	
14459	3000187	4-pt. Suspension	6	

JACKSON®
SAFETY



17330



19502



HARD HAT CUSTOMIZATION PROGRAM

Did you know? SureWerx recently acquired new, state-of-the-art automated hard hat customization equipment, allowing corporate logo placement on all Jackson brand hard hats.



Contact your local Jackson distributor for complete details.

HEAD PROTECTION — HARD HAT ACCESSORIES

Hard Hat Interchange System for Slotted Hard Hats

- One-button action for quick release, even with gloves on
- Vertical lock-in eliminates helmet/face shield creep
- Audible click — know your PPE is assembled correctly without visual inspection
- Keep your hard hat ANSI Z98.1 Class E rated with dielectric Hard Hat Interchange System
- Accommodates all Jackson Safety[®] face shields, HSL Series hoods, Halo X hoods and Nitro[®] hoods
- Allows operator to quickly change from face shield to welding helmet protection in seconds!
- A Jackson Safety[®] exclusive



CODE	Description	Case Count
39477	HHIS Master Kit contains all components necessary to mount welding helmets and face shields to your hard hat	6
38423	Replacement HHIS Knobs for 14425/14235/14238 QUAD 500™	6
38424	Replacement HHIS Knobs for 14202/14203 MAXVIEW™ and 14260/14262 F4XP	6
38425	HHIS Face Shield Kit contains all components necessary to mount face shields to your hard hat	6
38426	HHIS Welding Helmet Kit contains all components necessary to mount welding helmets to your hard hat	6
39476	Replacement Mounting Blades for SC-6 Series Hard Hats	6



JACKSON HARD HAT ACCESSORY COMPATIBILITY CHART

 Hard Hat Interchange System	CH-300	CH-400V	ADVANTAGE CAP STYLE	CHARGER	SENTRYIII	SC-6	ADVANTAGE FULL BRIM	BLOCKHEAD II	BLOCKHEAD FG	C10 BUMP CAPS
14939/14941 87 Mounting Blades			✓	✓	✓	✓				
14949 82 B Cap Adaptor			✓	✓	✓	✓				
14947 437 Cap Adaptor			✓	✓	✓	✓				
14944 382-B Cap Adaptor			✓	✓	✓	✓				
14391 Model P Cap Adaptor			✓	✓	✓	✓				
14948 Model 137 Cap Adaptor			✓	✓	✓	✓				
14390 Model C Cap Adaptor			✓	✓	✓	✓				
14943 Model 282-B Cap Adaptor										
14942 Model 182-B Cap Adaptor			✓	✓	✓	✓				
14946 Model 337 Cap Adaptor	✓	✓	✓	✓	✓	✓				✓
14505 Model A-5500SN Cap Adaptor			✓	✓	✓	✓				
14506 Model A-5500X Capshield				✓	✓	✓				
14393 Model H Cap Adaptor							✓	✓	✓	
14945 Model 37 Cap Adaptor							✓	✓	✓	
S61602 Cap Adaptor							✓	✓	✓	
S61900 Cap Adaptor	✓	✓	✓	✓	✓	✓				✓
S61600 Cap Adaptor			✓	✓	✓	✓				✓
S61601 Cap Adaptor							✓	✓	✓	
S61610 Cap Adaptor			✓	✓	✓	✓				
S61970 Universal Slot Adapter (USA)	✓	✓	✓	✓	✓	✓				
16797 Safe 2 System	✓	✓	✓	✓	✓	✓				
20774 H70 Vibe Ear Muffs Capmount Series	✓	✓	✓	✓	✓	✓				
S23409 Ear Muffs	✓	✓	✓	✓	✓	✓				
14202/14203 Maxview — HHIS	✓	✓	**	✓	✓	✓				
14225/14235/14238 Quad 500 — HHIS	✓	✓	**	✓	✓	✓				
DP4 — USA Adaptor			*	*	*	*				
380/390 Series — USA	✓	✓	✓	✓	✓	✓				
20933 Climbing Hard Hat Adaptor	✓	✓	✓	✓	✓	✓				

* Reverse Donning only **New HHIS version coming 2021

Drybrow Sweatband

- Keeps you cool and prevents perspiration from running into your eyes in hot and humid conditions
- Ideal for all applications where workers need to be kept cool and comfortable
- Individually sleeved for increased shelf life and vending machine incorporation
- **Finished dimensions:** 8.7" long x 1.6" wide x 5mm thick



16750

PRODUCT NO.	Old Code	Description	Case Qty.
16750	3005344	Drybrow Sweatband	25/Bag



14494



14496



14497



14502



14499

HARD HAT ACCESSORIES

AA-7 Windgard® Head Protection

- Snug fitting cap style fits over most partial brim hard hats
- Keeps wind out, traps warmth, and prevents moisture build-up
- Made with dielectric material to allow use near electrical hazards
- Provides warmth for temperatures from 32° to 0°F (0° to -20°C)

PRODUCT NO.	Old Code	Description	Case Qty.
14494	3000434	AA-7, Navy Blue	12/Pack
14495	3000435	AA-7, Orange	12/Pack
16756	3005341	AA-7, Red	12/Pack

AA-8 Windgard® Head Protection

- Fits over most full brim style hard hats
- Keeps wind out, traps warmth, and prevents moisture build-up
- Made with dielectric material to allow use near electrical hazards
- Provides warmth for temperatures from 32° to 0°F (0° to -20°C)

PRODUCT NO.	Old Code	Description	Case Qty.
14496	3000436	AA-8, Red	12/Pack

AA-9 Windgard® Head Protection

- Warmth for temps 0° to -20°F (-20° to -28°C)
- Full face and neck model protects mouth and cheeks
- Fits over most safety caps

PRODUCT NO.	Old Code	Description	Case Qty.
14497	3000434	AA-9, Navy Blue	12/Pack

SEASONAL WINTERLINERS

225 Plus Winterliner

- Can be worn under caps and hats
- Hook-and-loop fastener for a comfortable, close fit
- **Outer shell:** quilted nylon with extra-thick foam fill
- **Lining:** polyester fleece
- Meets 16 CFR 1610, Class 1

PRODUCT NO.	Old Code	Description	Case Qty.
14502	3000442	225 Plus Winterliner	12/Pack

325 Ultra Winterliner

- Ideal for cold weather environments
- Can be worn over hearing products
- Top section is flame-retardant
- Bottom section is flame-resistant
- Detachable bottom section is double-layered, heavy-spun polyester
- Nape piece closes with two buttons
- **Top shell:** cotton twill
- **Lining:** brushed 100% polyester fleece (top only)
- **Bottom shell:** double nylon knit
- Meets 16 CFR 1610, Class 1

PRODUCT NO.	Old Code	Description	Case Qty.
14499	3000439	325 Ultra Winterliner	3/Pack

SEASONAL WINTERLINERS

400 Ultra Winterliner

- Ideal for extreme cold weather environments
- Full head and neck coverage with extra-long nape and wraparound collar
- Shoulder length that can be tucked into jacket
- **Outer shell:** cotton twill
- **Lining:** polyester sherpa
- Meets 16 CFR 1610, Class 1

PRODUCT NO.	Old Code	Description	Case Qty.
14501	3000441	400 Winterliner	3/Pack

Wind Jammer IV

- Ideal for extreme cold weather environments
- Long nape and wraparound design provides extra warmth and a snug fit
- Silver with black fastener straps and elastic border stitching
- Meets 16 CFR 1610, Class 1

PRODUCT NO.	Old Code	Description	Case Qty.
16760	3005346	Wind Jammer IV	6/Pack

FLASH-TEX® LINERS

Flash-Tex® liners are designed to assist in complying with OSHA 1910.269.

FLASH-TEX® LINERS — 650 NPR AND 695 NPR

Flame-Resistant		Laundering Data		Char Length†	
Outer Shell	Inner Shell	Outer Shell	Inner Shell	Outer	Inner
Nomex® Inherently flame-resistant	Proban® durable flame-resistant	FR properties last lifetime	Retains FR properties up to 25 industrial washes or 50 domestic washes	2.4	3.5

Note: Data obtained from material manufacturers' testing. For additional technical information, contact Customer Service.
†The length of brittle residue when material is exposed to thermal energy

305 TSL Winterliner

- Ideal for cold-weather environments
- Full head and neck coverage with extra-wide wrapped collar
- Shoulder-length liner can be tucked into jacket

PRODUCT NO.	Old Code	Description	Case Qty.
14503	3000443	305 TSL Winterliner	3/Pack

695 NPR Winterliner

- Ideal for very cold weather environments
- Full head and neck liner with wide wraparound collar
- Universal to fit all head sizes
- Leather/Nomex® tabs attach to hard hats
- Provides protection from electrical arc energy exposure
- **Outer shell:** retains FR protection throughout life of product — 100% Nomex® IIIA
- **Inner shell:** flame resistance through 25 industrial washes or 50 domestic washes — 100% Proban® cotton

PRODUCT NO.	Old Code	Description	Case Qty.
16767	3005355	695 NPR Winterliner	3/Pack

Nomex® Head Winterliner

- 100% Nomex® double-layered, knitted hood provides extra protection around the face
- Full head and neck coverage with extra-wide collar
- Shoulder-length collar can be tucked into jacket
- Can be worn under a hard hat or welding helmet as protection against flame and electrical arcs
- Retains FR protection throughout life of the product

PRODUCT NO.	Old Code	Description	Case Qty.
14504	3000444	Nomex® Hood	12/Pack

JACKSON®

SAFETY



14501



16760



14503



16767



14504



JACKSON SAFETY® RESPIRATORS

Jackson Safety® particulate respirators deliver the protection you expect and the comfort you need for all-day wear.



R30	N99 Particulate Respirator
R20	P95 Particulate Respirator
R10	N95 Particulate Respirator
R05	Disposable Dust Mask

COLOR-CODED PARTICULATE DISPOSABLE RESPIRATORY PROTECTION

Jackson Safety® Brand Respiratory Protection Products

Product	CODE	Protection Level			Color Code			Valve
		N95	P95	N99	Blue	Yellow	Red	
R05	12978				Blue	Yellow	Red	None
R10	64230/64235	●			Blue	Yellow	Red	None
R10	64240	●			Blue	Yellow	Red	Single
R20	64420		●		Blue	Yellow	Red	Single
R30	64520			●	Blue	Yellow	Red	Single



64235

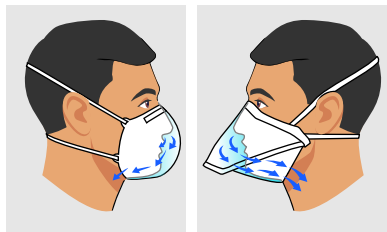

The N95 Pouch-Style Respirator is designed to increase air flow for better breathability

Introducing

The New R10 N95 Standard For All-Day Comfort, Fit, and Safety!



That's right! Jackson Safety is pleased to introduce an all-new N95 NIOSH-approved foldable disposable respirator designed for maximum all-day comfort. When your job requires the wearing of a protective mask, our Jackson 64235 introduces a new ultra-soft, ultra-comfortable respirator that significantly reduces facial irritation and discomfort. The pouch-style breathing chamber offers exceptional breathability while at the same time ensuring a minimum 95% filtration efficiency.

Look at these outstanding features:

- Ultra-soft non-irritating lining offers superior comfort over traditional N95 respirators
- Pouch-style breathing chamber provides exceptional breathability — check and compare!
- Two 1/2" extra-wide head straps and an adjustable nose clip further improves comfort and helps to ensure a tight facial seal, preventing leakage around the mask edges
- Nose clip reduces potential fogging of glasses and face shields
- Unlike traditional N95 masks, these respirators fold flat, reducing storage space requirements and shipping costs, as well as reducing the chance of product damage
- N95 NIOSH rating provides a minimum 95% filtration efficiency of 0.3 micron particles
- Features two layers of electrostatically treated melt-blown filter media,
- A single-use respirator designed for use by skilled professionals in critical environments who are mandated to wear specific PPE to protect against the transfer of aerosolized solid and non-oil based liquid/particulate matter
- Compatible with a variety of SureWerx protective eyewear and hearing protection
- Packed 50 per bag, 6 bags (300 pieces) per case
- **Disclaimer: Not intended for medical use**



PRODUCT NO.	Description	Shape	Baq Qty.	Case Qty.
64235	N95 Particulate Respirator	Pouch Style	50	6 Bags/300 Pcs

RESPIRATOR PROTECTION – DISPOSABLE RESPIRATORS

R05 Disposable Dust Mask

- Basic protection against non-toxic dust, household allergens, mold, and pollen
- Adjustable nose clip provides a secure fit
- Universal size
- Does not provide lung protection

PRODUCT NO.	Description	Case Count
12978	Disposable Dust Masks	50/Box, 20 Boxes/Case

JACKSON
SAFETY



12978

Due to overwhelming demand, please contact a SureWerx representative for delivery information.

R10 N95 Particulate Respirator

- Comfortable, soft foam nose pad
- Highly visible, color-coded straps
- Knitted elastic straps ultrasonically attached
- Not made with natural rubber latex
- Code 64240 meets heat and flame resistance per ANSI/ISEA 110-2009



PRODUCT NO.	Description	Protection	Strap Color	Case Count
64230	N95 Particulate Respirator (No Valve)	N95	Blue	20/Box, 8 Boxes/Case
64240	N95 Particulate Respirator (Single Valve)	N95	Blue	10/Box, 8 Boxes/Case



64230

R20 P95 Particulate Respirator

- Effective against all oil based and non-oil based particulate aerosols and dust that do not emit harmful vapors
- Soft foam nose pad with bendable nose clip
- Highly visible, color-coded straps
- Knitted elastic straps ultrasonically attached
- Not made with natural rubber latex



PRODUCT NO.	Description	Protection	Strap Color	Case Count
64420	P95 Particulate Respirator (Single Valve)	P95	Yellow	10/Box, 8 Boxes/Case



64420

R30 N99 Particulate Respirator

- Full perimeter foam inside mask
- Adjustable head straps
- Soft foam nose pad with bendable nose clip
- Highly visible, color-coded straps
- Knitted elastic straps ultrasonically attached
- Not made with natural rubber latex



PRODUCT NO.	Description	Protection	Strap Color	Case Count
64520	N99 Particulate Respirator (Single Valve)	N99	Red	10/Box, 8 Boxes/Case



64520



sellstrom

KneePro
ULTRA FLEX®

**KNEE & ELBOW
PROTECTION**

**ULTIMATE
COMFORT
ALL DAY
EVERY DAY**



KNEE PADS — PREMIUM GRADE

KneePro

ULTRA FLEX®



S96110

KneePro Ultra Flex III Knee Pads

- Sellstrom's **KneePro Ultra Flex III** knee pads have been the industry standard for more than 30 years
- Simply the best knee pads made!
- The articulating hinged design ensures proper placement all day long — set them once and forget you are even wearing them
- Soft elastic, extra-wide woven straps with reinforced sewn ends are placed well above and below the knee — no Velcro, which contaminates over time
- Straps stay aligned with your legs in any position — will not bind behind the knee
- Built with strong, flexible hard plastic outer shells that extend well above, below and to the inside/outside of the knee for added knee and leg protection
- Metal rivet hinge ensures long lasting protection while kneeling or walking
- On the outside, pads feature a perfectly placed curved non-marking Grip Strip
- Grip-Strip designed for use in all applications without gumming up
- Grip Strips are easily replaceable
- On the inside, pads offer a long lasting 5/8" closed cell foam pad for maximum comfort and protection (KneePro Ultra Flex III version)
- Sweat does not penetrate closed cell foam — lasts longer and won't "stink"
- **Our KneePro Hybrid Ultra Flex III** version offers even greater user comfort and protection through the use of a three layer, 3/4"-thick closed cell foam pad with built-in gel packs — the ultimate in knee protection!
- Virtually indestructible — built for years of hard work and heavy use
- Specially designed Quick-Snap clips ensure quick and easy removal
- Comes in convenient, reusable mesh bag with one extra Quick-Snap clip
- Pads weigh only 9 oz. each
- Straps, Grip Strips, and speedclips are replaceable
- Excellent for welders, ship builders, roofers, construction workers, flooring installers, and anywhere hard-working knee pads are required

KNEE PADS – PREMIUM GRADE

KneePro Ultra Flex III Knee Pads

PRODUCT NO.	Mod. No.	Shell Color	Grip Strip	Pkg. Qty.
S96110	KPUF03	Gray	Orange	6/24 Pair
S96111	KPUF03-B	Black	Black	6/24 Pair
S96112	KPUF03-G	OD Green	OD Green	6/24 Pair
S96113	KPUF03-T	Tan	Tan	6/24 Pair
S96114	KPUF03-F	Foliage	Foliage	6/24 Pair

KneePro “Hybrid” Ultra Flex III Knee Pads

- The **KneePro Hybrid Ultra Flex III** offers all of the same legendary features as the KneePro Ultra Flex III pad but has the added advantage of a built-in gel pack for added comfort and fit
- This is the ultimate knee pad for extreme applications where users are on their knees for extraordinarily long periods of time
- Unlike many gel pads on the market, our gel packs are securely placed inside a three-layer, 3/4" closed cell foam knee protector compartment and are guaranteed to stay leak free
- Available with black shells and hi-vis orange Grip Strip

PRODUCT NO.	Mod. No.	Shell Color	Grip Strip	Pkg. Qty.
S96211	KPUF03-H	Black	Hi-Vis Orange	6/24 Pair



sellstrom®

SELLSTROM

KNEE & ELBOW PROTECTION



S96111



S96112



S96113



S96114

sellstrom®



S96110-7



S96350

Serrated inner pads channel air flow, creating cooler working environment.



S96310

KNEE PADS – PREMIUM GRADE

KneePro Ultra Flex III Knee Pad Replacement Parts

KneePro

ULTRA FLEX®

PRODUCT NO.	Description	Set
S96110-7	KneePro III Replacement Grip Strips – Orange (PR)	1 Pair (2 pcs.)
S96110-6	Knee Pad Pro III Replacement Straps and Clips (Kit)	4 of Each

KNEE PADS – SPECIALTY

FOR
HIGH HEAT
APPLICATIONS

KneePro Roofers Knee Pads

- The KneePro Roofers vented foam rubber knee pads are specially designed for the tough roofers industry
- Manufactured using a special grade of ultra-dense rubber, offering extreme durability
- Non-marring rubber leaves no transfer on surfaces
- Inner pads are serrated, creating channels that allow air to flow through the pad
- These channels dissipate heat, creating a cooler working environment at the knee
- Ideal for roofers working in high-heat applications
- Straps are located to allow the calf muscle curvature to help hold the pads in place without pinching the knee joint
- The upper end of the pads is hooked upward and inward to help hold the pads in place on the knee
- Weight — 1.25 lbs. per pad, 2.5 lbs. per pair
- Ideal for roofers, welders, and anyone kneeling on heated surfaces

PRODUCT NO.	Mod. No.	Shell Color	Type	Pkg. Qty.
S96350	KPVFR	Black	Roofers	6/12

KNEE PADS – ADVANTAGE SERIES

KneePro ZeroGravity Lightweight Knee Pads

- The KneePro ZeroGravity knee pad is one of the lightest yet toughest knee pads on the market today — weigh only 2 oz. each
- So light, you won't even know you have them on!
- The outer shell is made using a durable, heat-formed, non-marking material for maximum life
- The inner closed cell foam protective pad is a full 1/2" thick for superior comfort
- Pad is molded to contour of knee, which helps it to stay in place during use
- Revolutionary new fastening system pops in and out like a button for easy and convenient on/off action
- To adjust the strap, simply pull the strap end to a comfortable size
- Extra-wide, soft woven elastic cloth strap for improved comfort and fit
- Economically priced but built for hours of long-lasting protection and comfort
- Ideal for roofing, plumbing, flooring, tiling, gardening, carpentry, electrical work, maintenance, and home repair

PRODUCT NO.	Mod. No.	Shell Color	Pkg. Qty.
S96310	KPZG03	Gray	20/100 Pair
S96311	KPZG03-G	OD Green	20/100 Pair

ELBOW PADS – PREMIUM SERIES

ArmorPro Tactical Elbow Pad

ArmorPro

- The ArmorPro Tactical Elbow Pad is the ultimate in elbow and arm protection
- The 11" long, abrasion-resistant foam and rubber body protects most of your arm
- Secures to your body with comfortable extra-wide top and bottom cinch straps
- Pull tabs help with adjustment even when wearing gloves
- Pad stays in position until **you** decide to change or remove
- Body is extremely flexible, becoming an extension of your arm
- Elbow protecting cap slides up and down for personal adjustment, comfort, and fit:
 - Shift cap to upper position for arm protection during belly crawl, or
 - Lower position for sniper stand off — your choice, your comfort
 - Tough grip cap holds your elbow in place on any surface
- Lightweight and cool — only weighs 7 ounces (each pad)
- Available in four colors: Black, OD Green, Tan and Foliage/Coyote Brown

PRODUCT NO.	Mod. No.	Shell Color	Pkg. Qty.
S96410	KPAP07-B	Black	6/12/24 Pair
S96411	KPAP07-G	OD Green	6/12/24 Pair
S96412	KPAP07-T	Tan	6/12/24 Pair
S96413	KPAP07-F	Foliage	6/12/24 Pair



sellstrom®

SELLSTROM

KNEE & ELBOW PROTECTION



S96410



S96411



S96412



WARNING: K1 and Due North® traction aids help give you traction on ice, snow, or similar porous surfaces. However, because NO product can completely prevent a slip or fall on slippery surfaces, remember to exercise care when walking or running in K1 and Due North® traction aids. Caution should also be taken when moving on any hard or polished surface, such as granite or marble, on ladders, or when driving a vehicle. Use care, as these traction aids are sharp and may injure or damage flooring, surfaces, or skin. K1 and Due North® traction aids are not to be used for mountaineering or hiking, in rocky terrain, or when the user may encounter steep up or down slopes. K1 and Due North® traction aids are not designed or intended to be used on high heel footwear. This product contains latex.



K1
S E R I E S

 **duenorth**[®]

SLIP PROTECTION

**KEEPING YOU
GROUNDED**

#1
Cause of Worker's
Compensation Claims

20.8%
of Emergency Visits

31
Days of Work Loss

SLIPS AND FALLS – THE #1 CAUSE OF WORKER'S COMPENSATION CLAIMS

THE CLEAR FACTS

More than **20,460** reported ice, sleet and snow related worker injuries in 2017 making up the majority of claims.

– U.S. Bureau of Labor Statistics

20.8% of emergency department visits and hospitalizations in the U.S. are due to slips and falls.

– EHS Today, "The High Cost of Slips, Trips and Falls"

25% of slips and falls result in more than 31 days away from work.

– National Floor Safety Institute

SUREWERX – THE #1 SUPPLIER OF PROFESSIONAL TRACTION AID SOLUTIONS IN AMERICA!

That's right. SureWerx offers the most complete range of traction aid solutions in North America, offering the original and industry-leading K1 mid-sole ice cleat brand, and the industry leader in full-sole and heel traction aids, Due North. Together, SureWerx offers the best one-two punch for all your traction aid needs. No matter the application, we have the solution!

K1[®]
S E R I E S

dn duenorth[®]



SLIP-ON TRACTION AIDS— THE FASTEST GROWING CATEGORY IN SAFETY

GROWING INDUSTRY

As more EHS professionals become aware of the available solutions, we are seeing more companies implement ice cleat policy

Companies are mandating ice cleats for all employees, including ones that don't necessarily work outside (i.e., office employees in the parking lot)

THE NUMBERS ADD UP

Average cost of an ice-related slip and fall worker's compensation claim is \$48,000, according to the Maine Department of Labor

At \$30 a pair, a company can outfit 1600 employees with a pair of ice cleats and save money if one accident is prevented

K1[®] MID-SOLE ICE CLEATS — THE MARKET DISRUPTOR S E R I E S

Since its development and introduction five short years ago, the K1 Series mid-sole ice cleat has revolutionized the slip protection market, preventing countless injuries across all industries and professions. K1, "The Grip that Changed the Game", is simply the most efficient method when transitioning from outdoors to indoors. It's easy and simple – just strap the mid-sole ice cleat to your foot wear (one size fits all). When in the down (active) position, the heavy-duty tungsten carbide spikes quickly penetrate icy surfaces, preventing slips and falls. When transitioning indoors, simply reach down and swivel the cleated area to the top of the footwear (inactive mode) to avoid damage to indoor surfaces. This innovative design is also great for use while driving! Drive with the ice cleat in the up (inactive) position, and down (active) when stepping out of the vehicle onto icy and slippery surfaces.



Slim

Low Profile

Original

High Profile



Flat-Sole Footwear

Aggressive Arch & Heel

SELECTION CHART →

CHOOSING THE CORRECT K1 SERIES™ MID-SOLE MODEL

It's very easy to determine which model best suits a company's employees with just a couple of questions:

	NO	YES
Will the ice cleat be worn in a volatile environment? E.g., Oil & Gas, Mining, Chemical, Refining	Original	Intrinsic
What kind of footwear is being worn?		
Traditional Heeled Work Boot	K1MID	K1MID-INT
Hiker Style or Tactical Boot	K1MID-LP	K1MID-INT-LP
Deep Treaded Boot	K1MID-HP	K1MID-INT-HP
Sneaker/No Heel	K1MID-SLM	



K1MID-BLK



K1MID-LP-BLK



K1MID-HP-BLK

K1 SERIES™ BLACK STRAP MODELS

NEW!

The K1 Mid-Sole Black Strap series offers a discreet option for winter traction, ideal for home care, government, military, law enforcement and first responders.



ORIGINAL

Regular length studs —
Ideal for most work boots with a defined heel

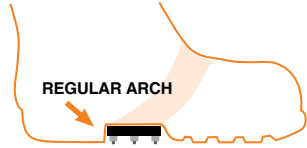

Total height 15mm



K1MID
Original



K1MID-INT
Intrinsic



K1MID-BLK
Black Strap

LOW PROFILE

Low profile studs —
For footwear with shallow arches

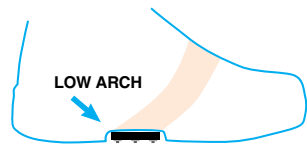

Total height 11mm



K1MID-LP
Original



K1MID-INT-LP
Intrinsic



K1MID-LP-BLK
Black Strap

HIGH PROFILE

High profile studs —
For boots with deep treads/high arches

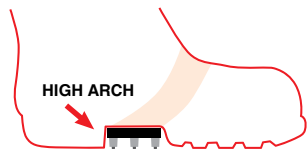

Total height 18mm



K1MID-HP
Original



K1MID-INT-HP
Intrinsic



K1MID-HP-BLK
Black Strap

SLIM

Ultra Low profile —
Patented duo-purpose indoor (non-cleated)/outdoor (cleated) mid-sole designed for flat-style footwear with little to no arches



Total height 8mm



K1MID-SLM

NEW!





K1 INTRINSIC MADE DIFFERENT. MADE SMART

When 'Non-Sparking' Brass Studs Are Not Enough

Certification is important. That's why we've done the testing to keep your team safe. **The K1 Intrinsic series is the ONLY Certified Intrinsically Safe ice cleat in North America.**

Mandated and trusted by oil and gas, utilities, waste water and agriculture for the most volatile environments – where safety matters most.

Burnable Material	USA (NEC)	Europe (IEC)
Gas or vapor	Class I, Div I	Zone 0, Zone 1, Zone 2
Dust	Class II, Div I	Zone 20, Zone 21, Zone 22
Fibers	Class III, Div I	Zone 20, Zone 21, Zone 22

In order to reach the required values of combined resistance for potentially explosive production environments, the K1 Mid-Sole Intrinsic Certified Spark-proof model must always be worn together with appropriate ESD footwear.



K1MID-INT



K1MID-INT-LP



K1MID-INT-HP



MORE THAN NON-SPARKING. K1 INTRINSIC ICE CLEATS

Special hi-vis orange and yellow strap for added protection

Available in three heights – original, low-profile and high-profile – a solution for any footwear



Expandable attachment strap ensures one-size fits all types of footwear

Features five exclusive, specially designed and formulated high performance intrinsically safe studs for certified use in potentially explosive environments

THE ONLY CERTIFIED INTRINSICALLY SAFE ICE CLEAT IN NORTH AMERICA!

K1 SLIM SERIES PATENTED DESIGN OFFERS SLIP PROTECTION INDOORS AND OUTDOORS



We listened. We innovated. Meet the new **K1 Slim**.

- Designed for flat-soled footwear like sneakers and safety shoes
- Ultra-thin design is comfortable and durable
- Made to be worn all day, indoors and out
- Ice-penetrating tungsten carbide studs
- One size fits all
- Outstanding traction

Indoor Use: Specially formulated non-spiked anti-slip material is in the down (indoor active mode) position to prevent slips and falls in slippery indoor conditions



Outdoor Use: Tungsten carbide spikes are in the down (outdoor active mode) position to prevent slips and falls in outdoor icy conditions

K1MID-SLM
Total Height: 8mm

The K1 Slim democratizes winter traction. Whether you're in and out of the warehouse, conducting home-care visits, or walking from the parking lot to the office, K1 Slim is convenient, smart, and safe.



EASILY SWITCH BETWEEN:

- Proven K1 Tungsten Carbide Studs
- Reliable anti-slip indoor traction

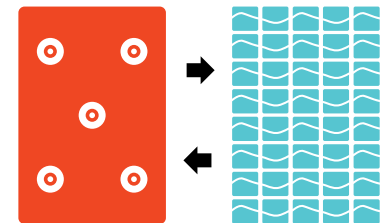

THE GRIP THAT CHANGED THE GAME™



ICE TRACTION AIDS

Superior in all ways!

- Exclusive "military grade" tungsten carbide replaceable spikes for superior strength
- Extra-strong spike material allows Due North to use a smaller diameter spike, resulting in faster, easier ice penetration while ensuring longest life!



Replaceable
ICE DIAMOND™
tungsten-carbide spikes

Due North products are manufactured using exclusive, specially formulated 100% rubber



Exclusive "Pulse Grip" tread design over a larger surface area provides even more traction on all surfaces

100% rubber is far superior to competitors using synthetic materials – check and compare!

ALL PURPOSE VERSION SHOWN

Provides maximum flexibility and durability in extreme cold conditions

LEADING THE WAY FOR REPLACEABLE SPIKE ICE TRACTION AID PERFORMANCE

Due North® Winter Traction product is ideal for those who walk, run, or work outdoors and require more stability and increased traction. Whether you're an industrial worker or someone who just needs extra stability in winter conditions, the enhanced design and improved shape will give you the extra confidence you need when walking or running on icy and snow conditions. The increased traction will help with preventing slips and falls on ice and snow, which reduces the risk of pulled muscles, fractured bones, or even back problems caused by a quick slip or fall. When not in use, the compact design makes them easy to store in small places, such as your coat pocket, handbag, briefcase, or the glove box in your vehicle.

due north®
INDUSTRIAL TRACTION



ICE TRACTION AIDS – HEAVY DUTY INDUSTRIAL

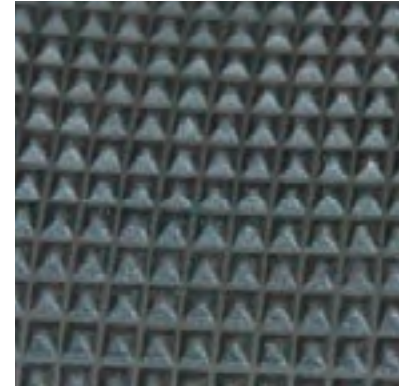

Textured "Diamond Knurling" lining grips footwear and helps keep traction aids in place

ICE TRACTION AIDS – HEAVY DUTY INTEGRATED SPIKES

FOR EXTREME APPLICATIONS

The solution for extreme winter work environments to give you the utmost confidence on ice and snow.

- Introducing the new Due North Heavy Duty
- 40% more natural rubber provides maximum cut and abrasion resistance while ensuring maximum performance for the life of the product
- Additional features include a built-in retention strap for a more secure fit and molded-in spikes; no additional accessories or replacement spikes are needed
- In comparison to our current industrial grade product, the Heavy Duty has 28 molded-in military grade tungsten carbide spikes

PRODUCT NO.	Old Code	Description	Strap Color	Spike Count	Size	Fits Men's Sizes	Fits Women's Sizes	Case Qty.
V3550570-S	heavyduty-sml	Heavy Duty	Black	28/Pair	Small	3-7	4-8	12
V3550570-M	heavyduty-med	Heavy Duty	Black	28/Pair	Medium	7.5-10	8.5-11	12
V3550570-L	heavyduty-lrg	Heavy Duty	Black	28/Pair	Large	10.5-13	11.5-13	12
V3550570-XL	heavyduty-osd	Heavy Duty	Black	28/Pair	Oversize	*see below	*see below	12

*Oversized fits sized and Pac boots size 10+ or standard footwear sizes 13.5-15.



ICE TRACTION AIDS – REPLACEABLE SPIKES



Tungsten carbide replacement spikes 100 pk.
V3550670-O/S



All-purpose carry pouch with belt loop
V3550970-O/S



All-purpose retention strap
V3550870-O/S

New "Pulse Grip" tread design over a larger surface area provides more traction on all surfaces

Repositioned Ice Diamond spikes provide more comfort under the foot and improved traction

8 (16/pair) strategically placed replaceable spikes



Improved heel fit for better performance

16 SPIKES PER PAIR!

Geometrically designed webbing and improved shape comfortably fit a greater variety of footwear

All-Purpose Industrial

- "Military" grade tungsten carbide "replaceable" spikes maximize traction and performance
- Sixteen tungsten carbide spikes per pair — our top-rated replaceable series for tough applications
- Heel pad features two extra spikes and enlarged heel coverage (versus All Purpose) for increased traction and stability
- Exclusive specially formulated 100% rubber — provides maximizes flexibility and durability in extreme cold conditions
- Specially designed "Pulse Grip" tread pattern offers added traction characteristics — maximum slip resistance
- Textured "Diamond Knurling" inner lining grips the footwear, keeping traction aids stable and in place
- Improved heel fit for improved performance
- Geometrically designed strap webbing and improved shape fit a greater variety of footwear — these traction aids stay on!
- Features molded-in retention strap attachment points
- For even greater security and fit, Due North offers an optional retention strap (sold separately)
- Industrial grade sole offers unparalleled grip, maximum durability, and superior operator safety
- The all-round solution for tough work environments — best for those who play hard and work harder outdoors.

PRODUCT NO.	Old Code	Description	Strap Color	Spike Count	Size	Fits Men's Sizes	Fits Women's Sizes	Case Qty.
V3550370-S	apindustrial-sml	All Purpose Industrial	Black	16/Pair	Small	4-7	5-8	12
V3550370-M	apindustrial-med	All Purpose Industrial	Black	16/Pair	Medium	7.5-10	8.5-11	12
V3550370-L	apindustrial-lrg	All Purpose Industrial	Black	16/Pair	Large	10.5-14	11.5-13	12
V3550370-XL	apindustrial-osa	All Purpose Industrial	Black	16/Pair	Oversize	*see below	*see below	12
V3550370-2XL	NEW!	All Purpose Industrial	Black	16/Pair	Oversize	Oversized/bulky footwear sizes 14-16+ or standard sizes 15+		12

*Oversized fits sized and Pac boots size 10+ or standard footwear sizes 13.5-15.

ICE TRACTION AIDS – REPLACEABLE SPIKES



New "Pulse Grip" tread design over a larger surface area provides more traction on all surfaces

Repositioned Ice Diamond spikes provide more comfort under the foot and improved traction

6 (12/pair) strategically placed replaceable spikes



Improved heel fit for better performance

12 SPIKES PER PAIR!

Geometrically designed webbing and improved shape comfortably fit a greater variety of footwear

All-Purpose

- "Military" grade tungsten carbide "replaceable" spikes maximize traction and performance
- Twelve tungsten carbide spikes per pair — excellent for general industrial applications
- Exclusive specially formulated 100% rubber — provides maximizes flexibility and durability in extreme cold conditions
- Specially designed "Pulse Grip" tread pattern offers added traction characteristics — maximum slip resistance
- Textured "Diamond Knurling" inner lining grips the footwear, keeping traction aids stable and in place
- Geometrically designed strap webbing and improved shape fit a greater variety of footwear — these traction aids stay on!
- Features molded-in retention strap attachment points
- Industrial grade sole offers unparalleled grip, maximum durability, and superior operator safety
- Easy to put on and take off, as well as easy to adjust
- All-around solutions for most footwear, including boots



**HEALTH
SAFETY
PRODUCTIVITY**

Be Smart. Be Safe. Be Sure.

PRODUCT NO.	Old Code	Description	Strap Color	Spike Count	Size	Fits Men's Sizes	Fits Women's Sizes	Case Qty.
V3550270-S	allpurposeng-sml	All Purpose	Black	12/Pair	Small	4-7	5-8	12
V3550270-M	allpurposeng-med	All Purpose	Black	12/Pair	Medium	7.5-10	8.5-11	12
V3550270-L	allpurposeng-lrg	All Purpose	Black	12/Pair	Large	10.5-14	11.5-13	12
V3550270-XL	allpurposeng-osd	All Purpose	Black	12/Pair	Oversize	*see below	*see below	12

*Oversized fits sized and Pac boots size 10+ or standard footwear sizes M 13.5-15, W 10+



ICE TRACTION AIDS – REPLACEABLE SPIKES



Light Industrial

Special rubber compound stays strong and retains elasticity in subzero temperatures for maximized durability

6 (12/pair) tungsten carbide Due North® Ice Diamond™ spikes are integrated into a proprietary rubber tread design for improved traction



Unique support hole on heel strap provides easy adjustment and makes it easy to put on and take off

12 SPIKES PER PAIR!

New and improved toe box design enhances fit and function along with a 360-degree spike pattern that provides more push and lateral grip

- “Military” grade tungsten carbide “replaceable” spikes maximize traction and performance
- Twelve tungsten carbide spikes per pair — excellent for general industrial applications
- Exclusive specially formulated 100% rubber — provides maximizes flexibility and durability in extreme cold conditions
- Improved toe-box design enhances fit and function
- Unique support hole on heel strap provides easy adjustment, allowing easy to put-on and take-off characteristics
- Proprietary tread design for added slip resistance
- A low-cost solution for light-duty, intermittent use work environments

PRODUCT NO.	Old Code	Description	Strap Color	Spike Count	Size	Fits Men's Sizes	Fits Women's Sizes	Case Qty.
V3550170-S/M	ltindustrial-s/m	Light Industrial	Black	12/Pair	Small/ Medium	3-7	5-9	12
V3550170-L/XL	ltindustrial-l/xl	Light Industrial	Black	12/Pair	Large/XL	8-14	10+	12

due north®
INDUSTRIAL TRACTION



ICE TRACTION AIDS – INDUSTRIAL HEEL



HTA Easy Flip Heel Traction Aid (Replaceable Spikes)

Ideal for drivers, delivery personnel, or anyone operating machinery where use of a conventional, full coverage traction aid may interfere with driving capabilities

The HTA offers a unique design feature that quickly allows the user to flip the traction pad underneath the heel (spike side in) when encountering a walking surface that may be damaged by exposed spikes



8 SPIKES PER PAIR!

- “Military” grade tungsten carbide “replaceable” spikes maximize traction and performance
- Eight tungsten carbide spikes per pair — excellent for general industrial applications
- Exclusive specially formulated 100% rubber — provides maximizes flexibility and durability in extreme cold conditions
- **Patented design** allows the user to easily and quickly flip the traction pad spike side in (facing the heel of the boot), or to simply slip the pad out from underneath the heel completely, resting on the back of the boot. Both functions eliminate spikes from damaging sensitive floor surfaces
- The flip-up position allows the operator to avoid damaging sensitive surfaces by removing the spikes from surface contact
- Ideal for drivers, delivery personnel, and machine operators where use of a full-coverage traction aid may interfere with driving capabilities
- One size fits most

PRODUCT NO.	Old Code	Description	Strap Color	Spike Count	Size	Case Qty.
V3550470-0/S	heeltractionaid	Heel Traction Aid	Black	8/Pair	One size fits most	12

Ideal for drivers, delivery personnel, and machinery operators!

! WARNING: Do not operate a motor vehicle with the HTA traction aid in active traction mode. The traction aid should always be in the “up” inactive mode position when driving.

It's as Easy as 1, 2, 3!



Full inactive mode or...



...Easily flip traction pad – spike side into heel



Flipped HTA traction pad – spike exposure eliminated

OUR RETAIL SELECTION



V3551270



V3551370



V3550270



V4550150



V4550250



V4550350

Slip Protection

- 100% natural rubber stays strong and retains elasticity in subzero temperatures for maximized durability
- Easy to take on and off
- Easily adjustable
- Replaceable military grade tungsten carbide spikes
- Twelve pair of Ice Diamond spikes per pair
- Molded designs ensure comfortable ergonomically superior fit
- Designed for running, walking or working while keeping your safe and secure

PRODUCT NO.	Old Code	Description	Strap Color	Size	Case Qty.
V3551270		Everyday G3	Black	S/M, L/XL	12
V3551370		Everyday Pro	Black	S/M, L/XL	12
V3550270		All Purpose	Black	S, M, L, XL	12

Rubz Massage

- Massage relief for tired achy feet
- Massage sore, tight, and tired muscles
- Rubz Ball is great for working sore hands and feet
- Rubz Ball and Rubz Massage Roller help to relieve plantar fasciitis
- Full body massage tool relieves tight and sore muscles in back, arms, shoulders, thighs and calves



PRODUCT NO.	Old Code	Description	Color	Case Qty.
V4550150-O/S		Foot Rubz Ball (English/Spanish package)	Green	24
V4550850-O/S		Foot Rubz Ball (English/French package)	Green	24
V4550250-O/S		Foot Massage Roller (English/Spanish package)	Purple	12
V4550650-O/S		Foot Massage Roller (English/French package)	Purple	12
V4550350-O/S		Full Body Massage Tool (English/French package)	Orange	12





SAFETY APPAREL



Pioneer History

The Pioneer story began in 1887 in boomtown Vancouver. In the 1890s, the founders grew the business quickly by supplying gear to prospectors arriving from all over North America heading to the famous Alaska/Yukon Klondike Gold Rush. These "sourdough prospectors", as they were called, fought mountainous terrain and the harshest climates in their long journeys to the northern goldfields. They relied heavily on their Pioneer gear to help them get the job done. Pioneer has now been keeping workers safe and comfortable for over 130 years.

Over these years, Pioneer has grown a reputation for designing and building high-quality and innovative protective and safety apparel. Using only the best/safest materials, componentry, and by using advanced sewing methods, Pioneer continues to deliver on safety, fit, durability, comfort and value for the professional worker.



Klondikers carrying supplies ascending the Chilkoot Pass, circa 1898

Today, Pioneer offers a complete selection of safety clothing including Hi-Vis gear, flame resistant wear, rainwear and much more... plus custom embroidery solutions. SureWerx combines Pioneer with the rest of the SureWerx family of safety brands to offer protection to workers from head to toe.

Why Choose Pioneer?

- Century long reputation for delivering the highest quality and most durable safety apparel
- Independently tested to meet and exceed all stated safety standards
- Innovative new product solutions based on the voice of the customer
- Unique bar tacking operation on all key seams, pockets, and other areas of stress
- Custom embroidery and silk screen solutions available
- Exclusive StarTech® reflective tape

Icon legend



Arc Resistant



Quick Dry



Thermal



Flame Resistant



Tear Resistant



Waterproof



Packable



Tear-Away



Women's



Temperature Range
ASTM F2732



TABLE OF CONTENTS

HI-VIS SAFETY VESTS	202-212
SAFETY SASHES & GAITERS	213
HI-VIS SAFETY SHIRTS	214-215
HI-VIS SAFETY HOODIES	216
HI-VIS TRAFFIC SAFETY WEAR	217
HI-VIS SAFETY RAINWEAR & JACKETS	218-225
FLAME RESISTANT SAFETY WEAR.....	226-227





HI-VIS SAFETY APPAREL

SAFETY, SECURITY, SELECTION



V1021840U
V1021860U
V1021850U

HI-VIS SAFETY VESTS

Women's Custom Fit Hi-Vis Safety Vest



- 136U/139U — ANSI/ISEA 107-15 Class 2 Type P and R
- 139PKU — ANSI/ISEA 107-15 Class 1 Type P Type O
- Tricot polyester
- Front zipper closure
- StarTech® reflective tape provides excellent visibility
- ID pocket with pen holders
- Storage, mobile phone, and inside pockets
- Nine total pockets
- Radiophone clip strand
- Tapered waist and flared bottom design made especially for women

PRODUCT NO.	MOD. NO.	Color	Sizes
V1021850U	136U	Hi-Vis Orange	XS-2XL
V1021860U	139U	Hi-Vis Yellow/Green	XS-2XL
V1021840U	139PKU	Pink	XS-2XL



HI-VIS SAFETY VESTS

Woven 150D Multi-Pocket Surveyor Vest

- ANSI/ISEA 107-15 Class 2 Type P and R
- 150 denier woven twill polyester
- StarTech® reflective tape provides excellent visibility
- Zipper front closure
- Radiophone pocket on chest
- Two radiophone clip straps
- Four front pockets with brass surveyor tape dispenser grommet
- Five pen pockets
- Seven other all-purpose storage pockets
- 19 pockets in total
- Cooling underarm mesh vents
- Back ruler slot
- Large back pack pouch with zipper access
- D-ring access slot

PRODUCT NO.	MOD. NO.	Color	Sizes
V1010151U	6692AU	Hi-Vis Orange	S-4XL
V1010141U	6693AU	Hi-Vis Yellow/Green	S-4XL

Mesh Surveyor Vest with Padded Collar

- ANSI/ISEA 107-15 Class 2 Type P and R
- Cool 4 oz. (120 GSM) hi-vis polyester mesh
- Durable and highly breathable mesh with mesh pockets
- StarTech® reflective tape provides excellent visibility
- Full-length zipper with extra-strong webbing reinforcement
- Padded collar for all-day comfort
- Water bottle/paint can holder at left side of waist
- Large radiophone/cell phone front pocket
- Two radiophone clip straps
- ID pocket with transparent window
- Chest pocket with pen slots
- Two inside full-width pockets with double hook-and-loop closure
- Inside tablet/storage pocket on left side with support strap
- Flap-covered chest pocket
- Lower pockets with flaps and grommets
- 11 pockets in total
- D-ring access slot below left chest pocket
- Full-width back panel with double-layer zip storage pouch

PRODUCT NO.	MOD. NO.	Color	Sizes
V1011150U	6730U	Hi-Vis Orange	S-4XL
V1011160U	6731U	Hi-Vis Yellow/Green	S-4XL



V1010141U
V1010151U



V1011160U
V1011150U



V1010260U
V1010250U

HI-VIS SAFETY VESTS

300D Oxford with Mesh Back Surveyor Vest

- ANSI/ISEA 107-15 Class 2 Type P and R
- Durable and breathable
- 4 oz polyester mesh back panel for cool ventilation
- Heavy-duty zipper front closure
- StarTech® reflective tape provides excellent visibility
- Radiophone clip straps
- ID pocket with transparent window
- Left chest pocket with pen slots
- Lower pockets with flaps and grommets
- Right and left inside tablet/storage pocket
- 12 pockets total
- D-ring access slot
- Full mesh back panel with double-layer bottom pouch

PRODUCT NO.	MOD. NO.	Color	Sizes
V1010250U	6672U	Hi-Vis Orange	S-4XL
V1010260U	6673U	Hi-Vis Yellow/Green	S-4XL



V1010460U
V1010450U

Full Mesh Surveyor Vest with Padded Collar

- ANSI/ISEA 107-15 Class 2 Type P and R
- Cool hi-vis mesh vest with solid material pockets
- 4 oz polyester mesh is durable and provides cool ventilation
- StarTech® reflective tape provides excellent visibility
- Heavy duty zipper closure
- Padded collar for all-day comfort
- Radiophone clip straps
- ID pocket with transparent window
- Left chest pocket with pen slots
- Right and left inside tablet/storage pocket
- 12 pockets total
- Full mesh back panel with double-layer bottom pouch
- D-ring access slot

PRODUCT NO.	MOD. NO.	Color	Sizes
V1010450U	6674U	Hi-Vis Orange	S-4XL
V1010460U	6675U	Hi-Vis Yellow/Green	S-4XL





V1021571U, V1021580U
V1020251U, V1020161U

HI-VIS SAFETY VESTS

Safety Vest

- 131BBAU/134BBAU — ANSI/ISEA 107-15 Class 2 Type P and R
- 135AU/134NAU — ANSI/ISEA 107-15 Class 1 Type O
- Tricot polyester interlock
- Zipper front closure
- StarTech® reflective tape provides excellent visibility
- ID pocket with pen holders
- Three storage pockets
- Eight pockets total
- Mobile phone pocket
- Two radiophone clip strands
- Adjustable 1 size up at sides

PRODUCT NO.	MOD. NO.	Color	Double Sizes
V1020251U	134BBAU	Hi-Vis Orange/Black	S/M-4/5XL
V1020161U	131BBAU	Hi-Vis Yellow/Green/Black	S/M-4/5XL
V1021571U	135AU	Black	S/M-4/5XL
V1021580U	134NAU	Navy	S/M-4/5XL



V1021061U
V1020951U

Safety Tear-Away Vest

- ANSI/ISEA 107-15 Class 2 Type P and R
- Tricot polyester interlock
- StarTech® reflective tape
- ID pocket
- Five-point tear-away
- Four sealed pockets
- Radiophone clip strap
- D-ring access slot
- Adjustable 1 size up at front

PRODUCT NO.	MOD. NO.	Color	Double Sizes
V1020951U	6930U	Hi-Vis Orange	S/M-4/5XL
V1021061U	6931U	Hi-Vis Yellow/Green	S/M-4/5XL



V1021260U
V1021150U
V1021170U

Zip-Up Snap Break Away Safety Vest

- 6935AU/6936AU — ANSI/ISEA 107-15 Class 2 Type P and R
- 6937AU — ANSI/ISEA 107-15 Class 1 Type O
- 6935AU/6936AU — CSA Z96-15 Class 2 Level 2
- 6937AU — CSA Z96-15 Class 1 Level 2
- Full mesh back panel
- Tear-away snaps on left side of zipper
- Reflective tape X-on back of vest
- StarTech® reflective tape provides excellent visibility
- Tricot polyester interlock front
- Zipper front closure
- Five-point tear-away/snap construction
- Four sealed pockets
- Two radiophone clip straps
- D-ring access slot

PRODUCT NO.	MOD. NO.	Color	Sizes
V1021170U	6937AU	Black	XS-5XL
V1021150U	6935AU	Hi-Vis Orange	XS-5XL
V1021260U	6936AU	Hi-Vis Yellow/Green	XS-5XL







V1060360U
V1060450U

HI-VIS SAFETY VESTS

Zip-Up Safety Vest

- ANSI/ISEA 107-15 Class 2 Type P and R
- Tricot polyester mesh provides cool comfort
- StarTech® reflective tape provides excellent visibility
- Cell phone pocket with flap
- Two lower pockets
- Full front zipper

PRODUCT NO.	MOD. NO.	Color	Sizes
V1060450U	6921U	Hi-Vis Orange	S-4XL
V1060360U	6922U	Hi-Vis Yellow/Green	S-4XL



V1030560U
V1030550U

Tear Away Mesh Safety Vest

- ANSI 107-15 Class 2 Type P and R
- Polyester mesh design
- StarTech® reflective tape provides excellent visibility
- Five-point tear-away
- D-ring access slot
- Adjustable one size up at front



PRODUCT NO.	MOD. NO.	Color	Double Sizes
V1030550U	597U	Hi-Vis Orange	S/M-4/5XL
V1030560U	598U	Hi-Vis Yellow/Green	S/M-4/5XL



V1024860U
V1024850U

Mesh Multi-Pocket Safety Vest

- ANSI/ISEA 107-15 Class 2 Type P and R
- Polyester mesh
- Zipper front closure
- StarTech® reflective tape provides excellent visibility
- Radiophone clip straps on each shoulder
- Four large pockets for items such as keys, phones, cards, wallets, etc.
- ID pocket with transparent window on right chest pocket
- Left chest pocket with pen slots and D-ring below
- Lower pockets with flaps
- Nine pockets total

PRODUCT NO.	MOD. NO.	Color	Sizes
V1024850U	6960U	Hi-Vis Orange	XS-5XL
V1024860U	6961U	Hi-Vis Yellow/Green	XS-5XL





V1025260U
V1025250U



V1025160U
V1025150U



V1025060U
V1025050U

HI-VIS SAFETY VESTS

Mesh Multi-Pocket Safety Vest

- ANSI/ISEA 107-15 Class 2 Type P and R
- 100% polyester mesh design for cool comfort
- StarTech® reflective tape provides excellent visibility
- Zipper front closure
- Left and right chest mic tab
- Left chest radiophone pocket
- Right chest two-tier, four-division pencil pocket
- Clear ID holder with flap
- Lower inside left tablet/storage pocket with support strap
- Eight pockets total

PRODUCT NO.	MOD. NO.	Color	Sizes
V1025250U	6853U	Hi-Vis Orange	S-5XL
V1025260U	6854U	Hi-Vis Yellow/Green	S-5XL

Multi-Pocket Safety Vest

- ANSI/ISEA 107-15 Class 2 Type P and R
- 100% polyester tricot
- StarTech® reflective tape provides excellent visibility
- Zipper front closure
- Left and right chest mic tab
- Left chest radiophone pocket
- Right chest two-tier, four-division pencil pocket
- Clear ID holder with flap
- Lower inside tablet/storage pocket with support strap
- Eight pockets total

PRODUCT NO.	MOD. NO.	Color	Sizes
V1025150U	6855U	Hi-Vis Orange	S-5XL
V1025160U	6856U	Hi-Vis Yellow/Green	S-5XL

Mesh Safety Vest

- ANSI/ISEA 107-15 Class 2 Type P and R
- 100% polyester mesh design for cool comfort
- StarTech® reflective tape provides excellent visibility
- Zipper front closure
- Self-color binding
- Value alternative to safety vests with pockets

PRODUCT NO.	MOD. NO.	Color	Sizes
V1025050U	6844U	Hi-Vis Orange	S-5XL
V1025060U	6845U	Hi-Vis Yellow/Green	S-5XL





V1023560U
V1023550U



V1023960U
V1023950U



V1030150U-O/S

HI-VIS SAFETY VESTS

Polyester Tricot Sleeved Safety Vest

- ANSI 107-15 Class 3 Type P and R
- Polyester tricot design for ultimate breathability
- Durable nylon front zipper
- StarTech® reflective tape provides excellent visibility
- Contrast binding on entire garment and on pocket openings
- Two radiophone clip straps
- Two chest pockets, two pockets waist pockets

PRODUCT NO.	MOD. NO.	Color	Sizes
V1023550U	6690U	Hi-Vis Orange	S-4XL
V1023560U	6691U	Hi-Vis Yellow/Green	S-4XL

Mesh Short Sleeve Safety Vest

- ANSI/ISEA 107-15 Class 3 Type P and R
- Breathable polyester mesh
- StarTech® reflective tape provides excellent visibility
- Zipper front closure
- Left chest cell pocket
- Radiophone clip straps on each shoulder

PRODUCT NO.	MOD. NO.	Color	Sizes
V1023950U	6790U	Hi-Vis Orange	S-4XL
V1023960U	6791U	Hi-Vis Yellow/Green	S-4XL

All-Purpose Mesh Vest

- Polyester mesh
- Yellow PVC reflective tape
- Five-point tear-away
- ID and pen pockets
- Three storage pockets
- Radiophone clip strap
- D-ring access slot

PRODUCT NO.	MOD. NO.	Color	Sizes
V1030150U-O/S	145U	Hi-Vis Orange	One size

SAFETY SASHES & GAITERS

Reflective Belt Vest

- Makes any plain garment more visible and safer
- Premium 1.5" elastic
- Adjustable elastic waist band and chest straps
- Quick-release waist buckle
- StarTech® reflective tape provides excellent visibility

PRODUCT NO.	MOD. NO.	Color	Sizes
V1041050U	5496U	Hi-Vis Orange	One size
V1041060U	5497U	Hi-Vis Yellow/Green	One size

Reflective Belt Vest Tear Away

- Makes any plain garment more visible and safer
- Premium 2" elastic
- Adjustable elastic waist band and chest straps fit all
- Quick-release waist buckle
- Four-point break-away
- StarTech® reflective tape provides excellent visibility

PRODUCT NO.	MOD. NO.	Color	Sizes
V1040850U	5591U	Hi-Vis Orange	One size
V1040860U	5592U	Hi-Vis Yellow/Green	One size



V1041060U
V1041050U



V1040860U
V1040850U





V1051160U
V1051150U



V1054060U
V1054050U



V1052160U

HI-VIS SAFETY SHIRTS

Birdseye Safety T-Shirt



- ANSI/ISEA 107-15 Class 2 Type P and R
- Soft premium birdseye moisture-wicking polyester
- StarTech® reflective tape provides excellent visibility
- Rib crew neck
- Chest pocket with hook-and-loop closure
- Radiophone clip strap

PRODUCT NO.	MOD. NO.	Color	Sizes
V1051150U	6990U	Hi-Vis Orange	S-5XL
V1051160U	6991U	Hi-Vis Yellow/Green	S-5XL

Birdseye Safety T-Shirt

- ANSI/ISEA 107-15 Class 2 Type P and R
- 100% moisture-wicking birdseye polyester
- StarTech® reflective tape provides excellent visibility
- Lightweight fabric provides all-day comfort
- Left chest pocket

PRODUCT NO.	MOD. NO.	Color	Sizes
V1054050U	6882U	Hi-Vis Orange	S-4XL
V1054060U	6883U	Hi-Vis Yellow/Green	S-4XL

Cool Pass® T-Shirt



- ANSI/ISEA 107-15 Class 3 Type P and R
- StarTech® Silver Zebra reflective heat-pressed tape
- 100% moisture-wicking birdseye material
- UPF 50+ UV protection
- Lightweight and breathable Cool Pass® fabric
- Stripe around each arm
- Crew neck

PRODUCT NO.	MOD. NO.	Color	Sizes
V1052160U	6901AU	Hi-Vis Yellow/Green	S-4XL



HI-VIS SAFETY SHIRTS

Birdseye Long-Sleeved Safety Shirt

- ANSI/ISEA 107-15 Class 3 Type P and R
- 100% moisture-wicking birdseye polyester
- StarTech® reflective tape provides excellent visibility
- Lightweight material for all-day comfort
- Left chest pocket
- Two stripes on arms

PRODUCT NO.	MOD. NO.	Color	Sizes
V1054250U	6887U	Hi-Vis Orange	S-4XL
V1054260U	6888U	Hi-Vis Yellow/Green	S-4XL

Birdseye Long-Sleeved Safety Shirt

- ANSI/ISEA 107-15 Class 3 Type P and R
- 100% moisture-wicking birdseye polyester
- StarTech® reflective tape provides excellent visibility
- Lightweight material for all-day comfort
- Left chest pocket
- One stripe on arms

PRODUCT NO.	MOD. NO.	Color	Sizes
V1051250U	6995U	Hi-Vis Orange	S-4XL
V1051260U	6996U	Hi-Vis Yellow/Green	S-4XL



V1054260U
V1054250U



V1051260U
V1051250U



V1060461U
V1060351U



V1060560U
V1060550U

HI-VIS SAFETY HOODIES

Polyester Fleece Hoodie

- ANSI/ISEA 107-15 Class 3 Type P and R
- Premium 10.5 oz (360 GSM) polyester fleece
- Double-stitched StarTech® reflective tape provides excellent visibility
- Detachable drawstring hood
- Elastic cuffs and hem
- Full front reversible zipper
- Two front slash pockets
- Two radiophone clip straps



PRODUCT NO.	MOD. NO.	Color	Sizes
V1060351U	6924AU	Hi-Vis Orange	S-5XL
V1060461U	6925AU	Hi-Vis Yellow/Green	S-5XL

Micro Fleece Zip Hoodie

- ANSI/ISEA 107-15 Class 3 Type P and R
- 7 oz (240 GSM) micro fleece
- Four-way comfort stretch
- StarTech® reflective tape provides excellent visibility
- Full front zipper
- Detachable drawstring hood
- Elastic cuffs and hem
- Two front slash pockets
- Two radiophone clip straps

PRODUCT NO.	MOD. NO.	Color	Sizes
V1060550U	6940U	Hi-Vis Orange	S-5XL
V1060560U	6941U	Hi-Vis Yellow/Green	S-5XL



HI-VIS TRAFFIC SAFETY WEAR



Traffic Safety Coverall

- ANSI/ISEA 107-15 Class 3 Type P and R
- StarTech® reflective tape provides excellent visibility
- Polyester knit
- Mesh ventilation panels on upper arms and legs
- Two-way brass zipper
- Two radiophone clip straps
- Two-way 28" leg zippers for ventilation and easy boot access
- Adjustable snap wrists
- Seven storage pockets: two rear, two chest, two side, one tool
- Hammer loop
- Two pass-through pockets
- Elastic waist

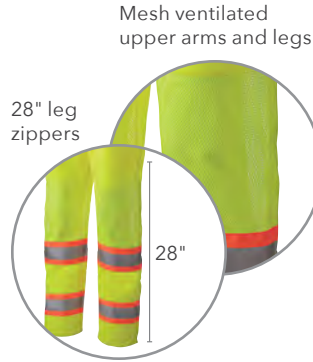

PRODUCT NO.	MOD. NO.	Color	Sizes
V1070160U	5999AU	Hi-Vis Yellow/Green	XS-5XL



V1070160U

Traffic Safety Pant

- ANSI/ISEA 107-15 Class E Supplemental Type
- StarTech® reflective tape provides excellent visibility
- Polyester knit
- Mesh ventilation panels on upper legs
- Brass zipper fly access
- Two-way 28" leg zippers for ventilation and easy boot access
- Five storage pockets: two side, two back, one tool
- Elastic waist with drawstring

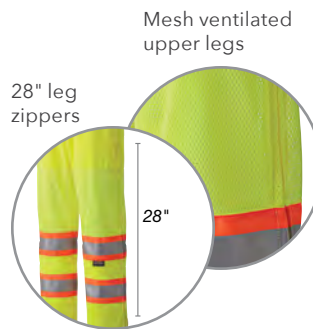

PRODUCT NO.	MOD. NO.	Color	Sizes
V1070360U	5999PU	Hi-Vis Yellow/Green	XS-4XL



V1070360U

Mesh Safety Pants

- ANSI/ISEA 107-15 Class E, Supplemental Type
- Class 3 when paired with ANSI Class 2 or Class 3 vest, shirt or jacket
- 100% polyester lightweight mesh
- Two pass-through pockets
- Drawstring waist
- StarTech® reflective tape provides excellent visibility

PRODUCT NO.	MOD. NO.	Color	Double Sizes
V1070760U	5670U	Hi-Vis Yellow/Green	2XS/XS-4/5XL



V1070760U



V3010460U

RAINWEAR

Three-Piece Repel Rainwear



- Welded seams for waterproof protection
- .35mm PVC/polyester material
- 100% waterproof and windproof
- Includes jacket, detachable hood, and bib pant

Jacket features:

- Vented back and underarms
- Two large front cargo pockets
- Zipper plus snap storm placket
- Corduroy collar

Bib pant features:

- Adjustable waist and suspenders
- Snap fly access

PRODUCT NO.	MOD. NO.	Color	Sizes
V3010460U	577AU	Yellow	S-5XL

HI-VIS SAFETY RAINWEAR



150D Oxford Poly/PVC Waterproof Suit

- ANSI/ISEA 107-15 Class 3 Type P and R
- Folds into a storage pouch
- 100% waterproof 150 denier hi-vis oxford polyester with PU backing
- StarTech® reflective tape provides excellent visibility
- Taped and heat-sealed seams
- Full back vent for breathability

Jacket features:

- Two lower flap pockets
- Drawstring with toggle on hem
- Half mesh-lined back
- Full front zipper
- Hood folds into collar

Bib Pant features:

- Elastic suspenders
- Metal buckles
- Snaps on leg hems



V1080360U
V1080350U

PRODUCT NO.	MOD. NO.	Color	Sizes
V1080350U	5618U	Hi-Vis Orange	S-4XL
V1080360U	5619U	Hi-Vis Yellow/Green	S-4XL

Lightweight Waterproof Suit

- ANSI/ISEA 107-15 Class 1/Class 1/Class E Type O/Supplemental Type
- Two pieces: hooded jacket and bib pant, fold into storage pouch
- StarTech® reflective tape provides excellent visibility
- 100% waterproof polyester/PVC
- Taped and heat-sealed seams

Jacket features:

- Back vents
- Adjustable hem
- Two large front cargo pockets
- Hood folds and zips into collar
- Full front zipper
- Drawstring with toggle on hem.

Bib Pant features:

- High-quality black elastic suspenders with non-corrosive plastic buckles
- Snap on hems to fit snug to boots.



V1080160U
V1080150U

PRODUCT NO.	MOD. NO.	Color	Sizes
V1080150U	5598U	Hi-Vis Orange	S-4XL
V1080160U	5599U	Hi-Vis Yellow/Green	S-4XL



PIONEER

HI-VIS SAFETY RAINWEAR



HI-VIS SAFETY RAINWEAR

Ripstop Waterproof Safety Jacket

- ANSI/ISEA 107-15 Class 3 Type P and R
- 100% waterproof and windproof
- StarTech® reflective tape provides excellent visibility
- Double-stitched and heat-sealed seams
- Abrasion, puncture, and tear resistant
- Front and back ventilation panels
- Fully mesh and taffeta lined back
- Fleece-lined collar with chin guard
- Two lower zip pockets, two lower inside pockets, and concealed zip cell phone pocket
- Two radiophone clip straps
- Full front two-way zipper with snap placket
- Elastic wrists with hook-and-loop closure
- 5400HU/5401HU (hood sold separately)



PRODUCT NO.	MOD. NO.	Color	Sizes
V1200251U	5400AU	Hi-Vis Orange	S-4XL
V1200261U	5401AU	Hi-Vis Yellow/Green	S-4XL



V1200261U
V1200251U

Hood for 300D Ripstop Waterproof Safety Jacket

- 300 denier durable ripstop polyester, PU coated
- Snap closure with drawstring
- Snaps for connecting to 300D ripstop jackets



PRODUCT NO.	MOD. NO.	Color	Sizes
V1200350U	5400HU	Hi-Vis Orange	One size
V1200360U	5401HU	Hi-Vis Yellow/Green	One size



V1200350U
V1200360U

300D Ripstop Waterproof Safety Bib Pant

- ANSI/ISEA 107-15 Class E, Supplemental Type
- 300 denier PU-coated ripstop polyester
- StarTech® reflective tape provides excellent visibility
- Double-stitched and heat-sealed seams
- Abrasion, puncture, and tear resistant
- 12" leg zippers with hook-and-loop plackets/adjustor straps
- Zippered closure inside bib pocket
- Zippered fly access
- Fully lined



PRODUCT NO.	MOD. NO.	Color	Sizes
V1200451U	5404AU	Hi-Vis Orange	S-4XL
V1200461U	5405AU	Hi-Vis Yellow/Green	S-4XL



V1200461U
V1200451U





V1081360U
V1081350U
V1082360U
V1082350U



V1120661U
V1120651U

HI-VIS SAFETY RAINWEAR

Hi-Vis Safety Jacket and Hi-Vis Safety Bib Pants



Jacket:

- 100% waterproof 300 Denier Oxford polyester w/ PU coating
- ANSI 107-15 Class 3 Type P and R
- StarTech™ reflective tape
- Taped and heat sealed seams
- Superior tear- and abrasion-resistant fabric
- Liberal fit and full back vent for working comfort
- Folds into zippered storage pouch
- Two lower flap pockets
- Half mesh lined back
- Full front zipper
- Hood folds into collar

Bib Pants:

- 100% waterproof 300 Denier oxford polyester w/ PU coating
- ANSI 107-15 Class E Supplemental Type
- StarTech™ reflective tape
- Taped and heat sealed seams
- Superior tear- and abrasion-resistant fabric
- Liberal fit for working comfort
- Elastic suspenders
- High-quality plastic buckles
- Two snap adjustment on leg hems to fit snug to boots
- Two-sided waist adjustment for better fit around waist

PRODUCT NO.	MOD. NO.	Color	Sizes
V1081350U	5626U	Hi-Vis Orange Jacket	S-4XL
V1081360U	5628U	Hi-Vis Yellow Jacket	S-4XL
V1082350U	5627U	Hi-Vis Orange Pants	S-4XL
V1082360U	5629U	Hi-Vis Yellow Pants	S-4XL

HI-VIS INSULATED RAINWEAR

Hi-Vis 100% Waterproof Quilted Bib Pant



- ANSI/ISEA 107-15 Class E, Supplemental Type
- Double-stitched StarTech® reflective tape provides excellent visibility
- 300 denier PU-coated oxford polyester with 5.3 oz (180 GSM) warm quilted polyester lining
- 100% waterproof and windproof
- 20" boot access two-way leg zippers with snap storm covers
- Double-stitched, taped and heat-sealed seams
- Two-way zipper with brass snap storm placket
- Premium adjustable elastic suspenders with quick-release clips
- Elastic waist
- Two front slash cargo pockets
- Sealed inside chest pocket with pen slot
- Outside chest pocket with flap

PRODUCT NO.	MOD. NO.	Color	Sizes
V1120651U	5040BBU	Hi-Vis Orange	S-4XL
V1120661U	5041BBU	Hi-Vis Yellow/Green	S-4XL

HI-VIS INSULATED RAINWEAR

Hi-Vis Waterproof 2-in-1 Bomber Jacket

- Outer jacket ANSI/ISEA 107-15 Class 3 Type P and R
- PU-coated oxford polyester shell
- 100% windproof and waterproof
- StarTech® reflective tape provides excellent visibility
- Removable inner fleece liner
- Embroidery access zipper on the inside
- Detachable snap hood with pouch to conceal hood
- Comfort collar with fleece lining
- Elastic ribbed cuffs and waist
- Full front zipper
- Two radiophone clip straps
- Two large front zippered pockets
- One cell phone pocket
- Inside chest pocket
- Black bottom to conceal soiling



2-in-1



V1130460U

PIONEER

HI-VIS INSULATED RAINWEAR

PRODUCT NO.	MOD. NO.	Color	Sizes
V1130460U	5209U	Hi-Vis Yellow/Green	S-4XL





HEAT CONTROL
BUTTON



V1210170U
V1210160U

HEATED OUTERWEAR

Heated Safety Nano Bomber Jacket



- ANSI/ISEA 107-15 Class 3 Type P and R (class 1 for black)
- Three-panel Nano Technology 4 levels of heat settings LED switch for on/off and heat levels
- Comes with USB port to connect to rechargeable power bank (power bank not included; must be purchased separately)
- 300 denier Oxford polyester, PU coated shell fabric
- 120GSM insulated with taffeta lining
- 100% waterproof and windproof
- Double-stitched and heat sealed seams
- StarTech® reflective tape
- Full front waterproof zipper
- Two lower slash pockets with waterproof zip, 1 lower inside zip pockets, laser chest zip pocket
- Two radiophone clip straps
- Three-piece lined detachable hood
- Fleece lined collar
- Elastic rib wrists
- Machine washable
- Sizes: S-4XL

PRODUCT NO.	MOD. NO.	Color	Sizes
V1210160U	5408AU	Hi-Vis Yellow/Green	S-4XL
V1210170U	5409AU	Hi-Vis Black	S-4XL

Power Bank Capacity (mAh)	HOURS OF KEEPING WARM*			
	Settings			
	Comfort 38°C/100.4°F	Cozy 43°C/109.4°F	Warm 48°C/118.4°F	Hot 53°C/127.4°F
5,000	6	5	4	3
10,000	9	8	7	6
15,000	12	11	10	9
20,000	15	14	13	12
25,000	18	17	16	15

*Based on 25,000 mAh Power Bank. Power bank not included.

The above chart is a guideline. Your results can vary based on the age and quality of the power bank used, outside temperatures and your own body heat. Test your power pack to ensure the length of performance with this jacket.

⚠️ WARNING: Cancer — www.P65Warnings.ca.gov

4 HEAT LEVELS	CARBON NANOTUBE TECHNOLOGY (CNT)	MULTI-HEATING ZONES	CONNECTS TO USB POWER BANK	UP TO 18 HOURS*	WATERPROOF & WINDPROOF	MACHINE WASHABLE

HI-VIS OUTERWEAR

Hi-Vis Safety Insulated Bomber Jacket

- PU-coated oxford polyester shell
- Meets ANSI 107-15 Class 3 Type P and R
- 160 GSM quilted poly insulation
- 100% windproof and waterproof
- StarTech® reflective tape provides excellent visibility
- Embroidery access zipper on the inside
- Detachable snap hood with pouch to conceal hood
- Comfort collar with fleece lining
- Elastic ribbed cuffs and waist
- Full front zipper
- Two radiophone clip straps
- Two large front zippered pockets
- One cell phone pocket
- Inside chest pocket
- Black bottom to conceal soiling



V1130560U

PRODUCT NO.	MOD. NO.	Color	Sizes
V1130560U	5208AU	Hi-Vis Yellow	S-4XL





Certified by UL



V2540310, V254031T
V2540350, V254035T

FLAME RESISTANT APPAREL



Flame Resistant Tech Premium Soft Coveralls



- ANSI/ISEA 107-15 Class 1 Type O
- FR-Tech™ 88% premium cotton blended with 12% high-tenacity nylon, 7 oz (240 GSM)
- Material and all components meet CGSB 155.20-2017 and NFPA 2112-2018 certified to UL
- Thermal Protective Performance (TPP) Value 9
- 7702/7702T — CSA Z96-15 Class 3 Level 2 and Class 3 Level FR
- 7704/7704T — CSA Z96-15 Class 1 Level 2 and Class 1 Level FR
- Meets ASTM F1506-2018, NFPA 70E-18 and CSA Z462-18
- ATPV 10 cal/cm² (Arc Thermal Protective Value)
- ARC 2 Arc Rating Category
- Double-stitched StarTech® FR reflective tape provides excellent visibility
- Sewn with aramid inherently FR thread
- Flame resistance guaranteed for the life of the garment
- Radiophone clip strap
- Two-way FR brass zipper
- Seven storage pockets: two back, two chest, two side, one tool
- Two pass-through pockets
- Adjustable wrists and ankles
- Superior flash fire and arc flash protection

PRODUCT NO.	MOD. NO.	Color	Waist Sizes
V2540350	7702	Orange	36-60
V254035T	7702T	Orange	40-60 Tall
V2540310	7704	Blue	36-60
V254031T	7704T	Blue	40-60 Tall

Certified by UL



V2570450U
V2570470U



Flame Resistant Zip-Style Heavyweight Cotton Safety Hoodie



- ANSI/ISEA 107-15 Class 1 Type O
- CSA Z96-15 Class 1 Level 2 and Class 1 Level FR
- 100% FR treated preshrunk cotton, 12 oz (400 GSM)
- Material and all components meet CGSB 155.20-2017 and NFPA 2112-2018 certified to UL
- Thermal Protective Performance (TPP) value: 12.6 cal/cm²
- Meets ASTM F1506-10a, NFPA 70E and CSA Z462-15
- ATPV 23 cal/cm² (Arc Thermal Protective Value)
- ARC 2 Arc Rating Category
- Double-stitched StarTech® FR reflective tape X on the back provides excellent visibility
- Sewn with inherently FR thread
- Two front slash pockets
- FR brass non-locking zipper
- Tough double-stitched seams
- Liberal sizing
- Detachable snap hood

PRODUCT NO.	MOD. NO.	Color	Sizes
V2570450U	3385FU	Orange	S-5XL
V2570470U	3375FU	Black	S-5XL

FLAME RESISTANT APPAREL

FLAME-GARD™

Flame Resistant Hi-Vis Vest

- ANSI/ISEA 107-15 Class 2 Type P and R
- FR treated polyester mesh
- Meets EN ISO 14116 Index 1
- Must be worn over an FR sleeved garment
- Five-point tear-away
- StarTech® FR reflective tape provides excellent visibility
- D-ring access slot
- Adjustable one size up at front



PRODUCT NO.	MOD. NO.	Color	Double Sizes
V2510850U	6914AU	Hi-Vis Orange	S/M-4/5XL
V2510860U	6916AU	Hi-Vis Yellow/Green	S/M-4/5XL



V2510860U
V2510850U





CLASS 1 – TYPE O

ANSI/ISEA 107-15 AMERICAN NATIONAL STANDARD FOR HIGH-VISIBILITY SAFETY APPAREL AND ACCESSORIES

What is **ANSI/ISEA 107-15** American National Standard for High Visibility Safety Apparel and Accessories?

The latest ANSI/ISEA 107-15 version consolidates the requirements of ANSI/ISEA 107-2010 and ANSI/ISEA 207, American National Standard for High-Visibility Public Safety Vests, in an effort to establish a single comprehensive document that considers all occupational tasks. The standard continues to present three performance classes of garments based on the amount of visible materials and design attributes incorporated into the final configuration, and identifies garment types based on expected use settings and work activities being performed. These are designated as off-road (type O), roadway and temporary traffic control (type R), or public safety activities (type P). For a detailed explanation of these standards, visit www.safetysafetyequipment.org/ansiisea-107-2015.

Listed below is a simplified explanation of the ANSI/ISEA 107-15 classes of garments:

CLASS 1 – TYPE O (Off Road)

Class 1 safety apparel are for workers whose jobs puts them at the lowest risk level. These would be for environments where traffic is traveling at or below 25 mph and work is taking place at a safe distance from a roadway. An example of this type of work would be sidewalk repair in a small residential neighborhood.

According to ANSI, in order for a vest to qualify as a Class 1 Type O safety apparel, it must have 217 square inches of background material in safety yellow or safety orange and have a minimum of 155 square inches of reflective tape. These reflective stripes must go around the middle of the vest as well as over the shoulder. These ANSI safety vests are designed to cover the torso only and do not require sleeves.

As defined by ANSI, "Performance Class 1 provides the minimum amount of high-visibility materials required to differentiate the wearer visually from non-complex work environments, in scenarios in which the struck-by hazards will not be approaching at roadway speeds, and therefore operative detection and identification distances."

- Basic harness or safety tape over the shoulders and encircling the waist.
- Suitable in less complex work areas where workers are separated from car and truck traffic.
- **Example:** Class 1 = Class 1 tape configuration + non-retroreflective background material.
- Pioneer model #135AU (V1021571U) Hi-Vis Safety Vest and Pioneer model #337SFU (V2570470U) Flame Resistant Zip Style Heavyweight Cotton Safety Hoodie are both Class 1 — Type O HVSA.



ANSI/ISEA 107-15 AMERICAN NATIONAL STANDARD FOR HIGH-VISIBILITY SAFETY APPAREL AND ACCESSORIES

CLASS 2 – TYPE R and/or P (Roadway, Temporary Traffic Control, and/or Public Safety)

Class 2 safety apparel is intended for working environments that pose a greater risk than Class 1. This can include workers who are on a roadway where traffic is moving under 50 mph. This apparel is larger than their Class 1 counterparts because they require more high visibility and reflective areas to be present. A Class 2 vest, for example, must have at least 775 square inches of safety yellow or safety orange background material and 201 square inches of reflective striping. Class 2 apparel are commonly worn by survey crews, airport baggage handlers, and school crossing guards.

- Full coverage of the upper torso including front, back, sides and over the shoulders.
- The background material must be high visibility.
- For use in more complex or low-light work areas requiring greater visibility.
- **Example:** Class 2 = Class 2 tape configuration + retroreflective background material.
- Pioneer model #6990U (V1051150U) **Birdseye Safety T-Shirt** is a Class 2 — Type R and P garments.



CLASS 2 – TYPE R AND/OR P

CLASS 3 – TYPE R and/or P (Roadway, Temporary Traffic Control, and/or Public Safety)

Class 3 safety apparel is reserved for people working in the most dangerous environments where visibility is the highest priority. This includes roadways where traffic is traveling in excess of 50 mph, but it can also apply to emergency personnel or tow truck operators working in extreme weather conditions where visibility is at a minimum.

Class 3 ANSI approved safety apparel requires the most background fabric and reflective striping. The standard includes 1,240 square inches of safety yellow or safety orange background with 310 square inches of reflective striping.

As defined by ANSI, “Performance Class 3 can offer greater visibility to the wearer in both complex backgrounds and through a full range of body movements by mandatory placement of background, retroreflective and combined-performance materials on sleeves and pant legs (if present). Regardless of the area of materials used, a sleeveless garment or vest alone shall not be considered Performance Class 3.”

- A Class 2 garment combined with arm and leg bands.
- The background material must be high visibility to the standard.
- Hi-Vis coveralls meet this standard; safety jackets (Class 2) and pants (Class E) can be worn combined, or arm/leg bands can be added to Class 2 garments, to attain Class 3.
- Suitable for use in complex work areas where low light, fast-moving traffic and inclement weather are safety factors.
- **Example:** Class 3 = Class 3 tape configuration + retroreflective background material
- Pioneer model #6690U (V1023550U) **Hi-Vis Safety Vest With Sleeves**, Pioneer model #5999AU (V1070160U) **Hi-Vis Traffic Safety Coverall** are all Class 3 — Type R and P garments.



CLASS 3 – TYPE R AND/OR P



SUPPLEMENTAL CLASS E

ANSI/ISEA 107-15 AMERICAN NATIONAL STANDARD FOR HIGH-VISIBILITY SAFETY APPAREL AND ACCESSORIES

SUPPLEMENTAL CLASS E

ANSI Supplemental Class E applies to Hi-Vis pants, bib overalls, shorts, and gaiters. Alone, these garments are not ANSI compliant. When combined with a Class 2 or Class 3 garment, the combination satisfies Class 3 requirements. This classification remains the same under the ANSI/ISEA 107-2015 standard.

ANSI designates "pants, bib overalls, shorts, and gaiters" as Class E.

- Class E garments must always be worn in combination with other items to meet HVSA PPE requirements.
- Class E items worn in combination with Performance Class 2 or Class 3 items will achieve an overall classification of Performance Class 3.
- Pioneer model #5404AU (V1200451U) **Hi-Vis 300D Ripstop Waterproof Safety Bib Pant** and Pioneer model #5999PU (V1070360U) **Hi-Vis Traffic Safety Pant** are both Class E HVSA.

Safety officials in your region determine the appropriate class wear for specific job sites. Hazardous risk assessment should be performed by a qualified individual to determine the applicable high visibility classification.





SIZING CHART

Body Measurements (not garment measurements)

Jackets, Coveralls, Overalls																						
	XS		S		M		L		XL		2XL		3XL		4XL		5XL		6XL		7XL	
Size	32	34	36	38	40	42	44	46	48	50	52	54	56	58	60	62	64	66	68	70	72	
Chest	32	34	36	38	40	42	44	46	48	50	52	54	56	58	60	62	64	66	68	70	72	
Waist	26	28	30	32	34	36	38	40	42	44	46	48	50	52	54	56	58	60	62	64	66	
Arms	32	33		34		35		36		37		38		39		40		41		42		
Hip	32	34	36	38	40	42	44	46	48	50	52	54	56	58	60	62	64	66	68	70	72	

Pants (overalls are sized based on chest measurements)																						
	XS		S		M		L		XL		2XL		3XL		4XL		5XL		6XL		7XL	
Size	26	28	30	32	34	36	38	40	42	44	46	48	50	52	54	56	58	60	62	64	66	
Waist	26	28	30	32	34	36	38	40	42	44	46	48	50	52	54	56	58	60	62	64	66	
Hip	32	34	36	38	40	42	44	46	48	50	52	54	56	58	60	62	64	66	68	70	72	
Inseam	30.5	31		31.5		32		32.5		33		33.5		34		34.5		35		35.5		

Shirts (select size by neck for closed collar shirts, by chest for open collar shirts)																				
	S		M		L		XL		2XL		3XL		4XL		5XL		6XL		7XL	
Neck	14-14.5		15-15.5		16-16.5		17-7.5		18-18.5		19-19.5		20-20.5		21-21.5		22-22.5		23-23.5	
Chest	34		38		42		46		50		54		58		62		66		70	
Sleeve	33.5		34		34.5		35		35.5		36		36.5		37		37.5		38	

Women's Garment Sizing												
	XS		S		M		L		XL		2XL	
Chest	32		34		36		39		42		45	
Waist	24		26		28		31		34		37	
Arms	29		30		31		32		33		34	
Hip	35		37		39		42		45		48	
Inseam	27		28		29		30		31		32	

All measurements in inches.

Talls in Coveralls are 2 inches longer in the torso and 1 inch longer in the sleeves and legs.

Measurement Directions:

- Neck:** Measure around the base of your neck, round up to the next half-inch.
- Chest:** Measure around your chest, under the arms and across the shoulder blades, over a shirt if stomach is larger than chest; choose the larger size.
- Waist:** Measure around your waist at the level you normally wear your pants, over a shirt.
- Hip:** Standing with feet together, measure around the widest part of your hips, parallel to the floor.
- Inseam:** Measure a good-fitting pair of pants along the inseam, from crotch seam to bottom edge of cuff.
- Sleeve:** Bend arm and place fist on hip. Measure from center back of your neck, across shoulder and down arm to elbow and then to your wrist. This is your sleeve length.

For working garments, measure liberally to find your size, as you need freedom of movement.

STAR★TECH®

STARTECH® reflective tape is exclusive to Pioneer safety products. It is designed and tested to far exceed the ANSI/ISEA 107-15 high-visibility safety apparel reflective tape standard.



StarTech® reflective tape has been independently tested to meet:

- ANSI 107-15 American National Standards Institute
- EN ISO 20471 High-Visibility Standard Level 2 high-visibility safety apparel and accessories

StarTech® FR tape is made of FR cotton or aramid material as backing and has been independent lab-tested to meet:

- CGSB 155.20-2017 (Heat-Resistant Test)
- NFPA 2112-2018 Standard on Flame-Resistant Garments for Protection of Industrial Personnel against short duration thermal exposure from fire

The many standards for reflective tapes all require passing a battery of tests that simulate working conditions.

These include measuring the retroreflective performance of StarTech® tape after being subjected to abrasion, multiple flexing, cold temperatures, variable temperatures, multiple washings, wet conditions, and, for the FR version, its heat resistance properties as well. Due to its premium design and quality, StarTech® tape not only meets but exceeds all of these standards!



NFPA (National Fire Protection Association) 2112-2018 — Standard on Flame-Resistant Garments for Protection of Industrial Personnel Against Flash Fire

- NFPA 2112-2018 requires 3rd party certification through UL.
- Tests performed under NFPA 2112:
 1. Heat transfer performance — predict burn injury (2nd or 3rd degree burn).
 2. Flame resistance — ASTM D6413 as received and after 100 wash cycles. Tested for 3 secs.
 3. Thermal shrinkage resistance/Heat resistance test — Oven test at 260°C.
 4. Manikin testing — ASTM F1930 — Manikin has sensors and is subjected to 84kW/m² for flame for 3 secs. to verify if 2nd or 3rd degree burns are recorded.
 5. Thread melting resistance — 260°C of heat is applied to verify if thread melts.
 6. Other tests included: label legibility, fabric weight, tensile strength, tear strength, material burst strength, laundering shrinkage, colorfastness, seam efficiency.

Electric Arc Standards

Test Method:

- ASTM F1506-2018 — Standard Performance Specification for Flame Resistant and Arc Rated Textile Materials for Wearing Apparel for Use by Electrical Workers Exposed to Momentary Electric Arc and Related Thermal Hazards.

Standards:

- NFPA 70E-2018 — Standard for Electrical Safety in the Workplace.

What is ARC Flash?

When an electric current passes through air between underground conductors or between underground conductors and grounded conductors, temperatures can reach 20,000°C (35,000°F).

Exposure to these extreme temperatures burns the skin directly and ignites clothing, which adds to the burn injury.

The majority of hospital admissions due to electric accidents are from arc flash burns, not from shocks.

ASTM F1506-2018

- Both NFPA 70E and CSA Z462 define the following categories for ARC rated clothing
- ATPV (Arc thermal protective value) — point at which 2nd degree burn is registered on the sensor and fabric is still intact
- EbT (Break-open threshold) — point at which 2nd degree burn is registered on the sensor and fabric has broken/formed a hole
- Minimum ARC rating required 4 Cal/cm²
- ARC 1 — 4 Cal/cm² to 7.9 Cal/cm²
- ARC 2 — 8 Cal/cm² to 24.9 Cal/cm²
- ARC 3 — 25 Cal/cm² to 39.9 Cal/cm²
- ARC 4 — 40 Cal/cm² and up.

Tests in this standards go way beyond testing for ARC rating:

- Breaking load test — Grab test
- Tear resistance
- Seam slippage
- Colorfastness — Laundering/Dry Cleaning — three cycles of washing
- Dimensional Change — Max 3%
- Flammability — Char length needs to be below 150mm
- Before and after 25 washes, Bursting strength, Arc Rating

WARRANTY

Garment and Safety Gear

Pioneer warrants all garments to be free of defects in materials and workmanship under the normal use for which the product is intended. Normally, a garment defect of manufacture will show up in the first two months of use.

This warranty is limited to product failure as a result of seam separation, broken snaps or zippers, material delaminating, or any defect in material or workmanship that affects the performance of the garment.

Excluded from this warranty are products that have been affected by cuts or punctures, disfigured from continued wear or use, and products that have been exposed to solvents or excessive heat which may degrade their performance and garments that have not been maintained as per wash care instructions on the garment.

Warranty claims will only be provided for those products that have been made available for inspection by Pioneer. Any warranty claim on garments that have been purchased over 60 days ago will have to be accompanied by pictures and/ or defective garment itself for inspection. To maintain our health and safety standards, all products returned for inspection must be free of all removable debris. Any products returned that do not meet the above conditions will be returned to the customer at their expense.

Pioneer shall not be liable for indirect, special, incidental, or consequential damage or penalties and does not assume liability of purchaser or others for injury to persons or property.

For a warranty claim on a Pioneer garment, please contact your local sales or customer service representative.



PEAKWORKS™

FALL PROTECTION



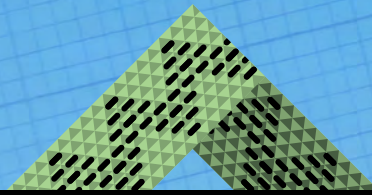

PEAKWORKS®

FALL PROTECTION

TABLE OF CONTENTS

HARNESSES AND BELTS	241-259
SELF-RETRACTING LIFELINES	260-270
LANYARDS	271-274
VERTICAL LIFELINES AND ROPE GRABS	275-277
ANCHORAGE CONNECTORS.....	278-282
TANK TROLLEYS.....	283
KITS.....	284-296
HARDWARE AND ACCESSORIES	297
LADDER SAFETY SYSTEM	298-305
EMERGENCY DESCENT SYSTEMS	306-307
ENGINEERED SYSTEMS	308
TOOL TETHERING SYSTEMS	309-314
STANDARDS AND REGULATIONS	315



PEACE OF MIND

PeakWorks Knows Fall Protection

From its inception in 2008, PeakWorks has been passionate about providing workers peace of mind when working at heights. The PeakWorks founders, with over 50 years of fall protection experience between them, set out to build a company that not only offered an industry-leading product line, but also provided their customers with value-added services supplying real solutions for both workers and the companies employing them. Today, as an integral part of our family of brands, we embrace those same principles. We know that the best fall protection is to eliminate the fall hazard in the first place. However, we also know that life doesn't always work that way. Our single goal, then, remains very simple: to ensure the best possible outcome when the unexpected occurs.

PeakWorks Embraces Industry Standards

Our in-house fall protection experts are driven to provide the best possible products and systems to ensure maximum worker safety. Like you, we live and work in North America, and we are intimately knowledgeable about the strict regulations imposed in this country, which has the highest standards in the world. In fact, we are so dedicated to the advancement of worker safety that our fall protection experts are active members of both the CSA and ANSI standards committees. Not only do we adhere to these standards, we help to develop them!

PeakWorks Thrives on Problem Solving

PeakWorks is all about solving problems for workers at height. Our team of experts is available to consult on applications, hazard analysis training, recertification of products and much more. If you need help, we are just a phone call away!

PeakWorks Offers Uncompromising Value

Great news! Not only have we developed a world-class fall protection program, we have also made every effort to ensure that it is delivered at the best value to you, the customer. We have accomplished this without compromising product quality – your safety remains our primary objective. So give us a call and let us know how PeakWorks can not only exceed your safety expectations but potentially lower your overall fall protection costs at the same time.

ANSI Certification

Products that are certified to the ANSI standard is much different than products that meets or exceed ANSI standard. Certified to ANSI means that the product has been tested and certified by a third party testing facility that have meet all the requirements of ISO 17025. The products undergo all the testing that is set forth by the ANSI standard to qualify as certified product. This gives the user an extra level of assurance that the product will perform as designed. On the other hand, if a product has the term "Meets or exceeds" on the labeling or instruction manual, it simply means that the manufacturer has tested the products internally usually without a third-party verification. It's important that you as the user of the equipment understand these difference so that you can make an informed decision on the products you are using or specifying to use in the field.

FALL PROTECTION DEFINED

What is Fall Protection?

Fall Protection refers to a series of regulated products or systems designed to protect workers from the risk of falls when working at height.

Types of Fall Protection

There are three basic types of fall protection available on the market:

Fall Restraint – Comprised of products or equipment which prevent a free fall from happening in the first place. The fall restraint system is designed to prevent a worker from ever reaching the edge or drop-off point when working at heights. Common examples: Guard Rails or Restraint Lanyards connected to Full Body Harnesses that are shorter in length than the distance from the Anchor Point to the Drop-Off Point.

Fall Arrest – Comprised of products, equipment or systems which stop a free fall once it occurs. These products are carefully designed and tested to stop a falling worker with minimal risk of injury. Common examples: Full Body Harnesses connected to Shock Absorbing Lanyards, or Self-Retracting Lifelines that are connected to an approved Anchor Point.

Work Positioning – Comprised of products or equipment which support or suspend a worker in order to allow the worker to be positioned at their working point hands-free. Common examples: Rebar Chain Assembly, Boatswain's Chairs, Descent Controllers.

Know Your ABCs

Fall protection systems are designed to prevent contacting a lower level if you fall from a height. There are several key components to these systems and it is important to know the basics.

A = Anchorage Connectors – The Anchorage is an engineered product which connects to some form of structure. The combination of these two critical components must be capable of withstanding the forces incurred during a fall. In North America, these components must be capable of withstanding a minimum 5,000 lb (22 kN) of force. Common examples: Anchor Slings, Fixed D-Rings, Beam Anchors, Concrete Hole Anchors, Carabiners.

B = Body Support – The Body Support is the component that is worn on or around the torso. There are two types of Body Support:

Restraint Belt:

Belt that is installed at the waist and used for worker positioning and travel restraint. A Restraint Belt must NEVER be used for fall arrest.

Full Body Harness:

A Full Body Harness is a body support device that is installed on the entire body and is designed to distribute the forces of a fall to the shoulders, thighs and pelvis.

All Full Body Harnesses have a back D-ring designed for the fall arrest connection point. Other styles of Full Body Harnesses are available with other attachment points such as side D-rings for work positioning, a frontal D-ring for ladder climbing, and shoulder D-rings for confined space work. Some styles of harnesses can also have a combination of all or some of these attachment points, for example our Class APLE has the following connection points: (1) back D-ring, (2) side D-rings, (1) frontal D-ring and (2) shoulder D-rings.

Full Body Harnesses are the only accepted body support to be used for a fall arrest application. NEVER use a Restraint Belt in a fall arrest application.

C = Connectors – Connectors are the engineered components that connect the Body Harness or Body Belt to the appropriate Anchorage. Common examples: Shock Absorbing Lanyards, Self-Retracting Lifelines (SRLs), Restraint Lanyards, Lifelines.





PEAKWORKS™

HARNESSES

SECURING YOUR PEACE OF MIND



FULL-BODY HARNESSES

About Full-Body Harnesses

- Full-body harnesses are designed to arrest a fall while simultaneously distributing the tremendous shock or load to the worker's body.
- There are many applications and conditions in which full-body harnesses must be worn. In order to maximize effectiveness and minimize injury, it is critical that an appropriate body harness be selected based on the job for which it is intended. PeakWorks offers a full range of body harnesses for almost every application.
- Full-body harnesses must be fitted and tightened properly to ensure maximum protection and to minimize injury.
- Waist or restraint belts are not replacements for full-body harnesses.
- All PeakWorks full-body harnesses are built to meet or exceed the highest standards while providing maximum fit and comfort.

Harness Classes

- Full-body harnesses come in many styles with a variety of attachment points (D-rings). The placement of these D-rings is critical to the type of application and positioning of the worker when performing a job.
- The fall protection industry and regulatory committees have standardized the positioning of these attachment rings into Harness Classes A, D, E, L, P.
- Depending on the application, full-body harnesses may require more than one attachment class in order to correctly position the body and stress points during a fall; i.e., AE and AP.
- All full-body harnesses come with a standard Class A D-ring (located at the back between the shoulder blades).



Class A
Fall Arrest



Class D
Descent



Class E
Limited Access



Class L
Ladder



Class P
Work Positioning

Harness Hardware

PeakWorks full-body harnesses are available with a variety of buckle types for your convenience:



Pass-Thru Chest Strap



Pass-Thru Leg Strap



Grommeted Leg Strap



Stab Lock Chest
or Leg Strap



Friction Torso Adjustment
or Leg Strap

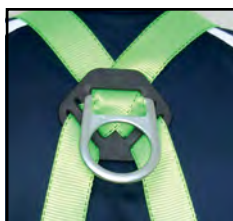

Large Back D-Ring



Padded Back Support

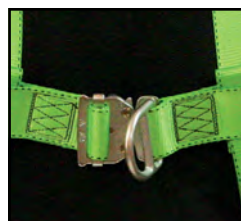

Frontal D-Ring



Lanyard Park

UNIVERSAL HARNESS SIZE CHART

HGT/WGT	130	140	150	160	170	180	190	200	210	220	230	240	250	270	290	310
6'8"																
6'6"																
6'4"																
6'2"																
6'0"																
5'10"																
5'8"																
5'6"																
5'4"																
5'2"																
5'0"																
4'10"																

S/M/L
Universal Fit Range

XS

XL/XXL

HARNES D-RING LOCATIONS

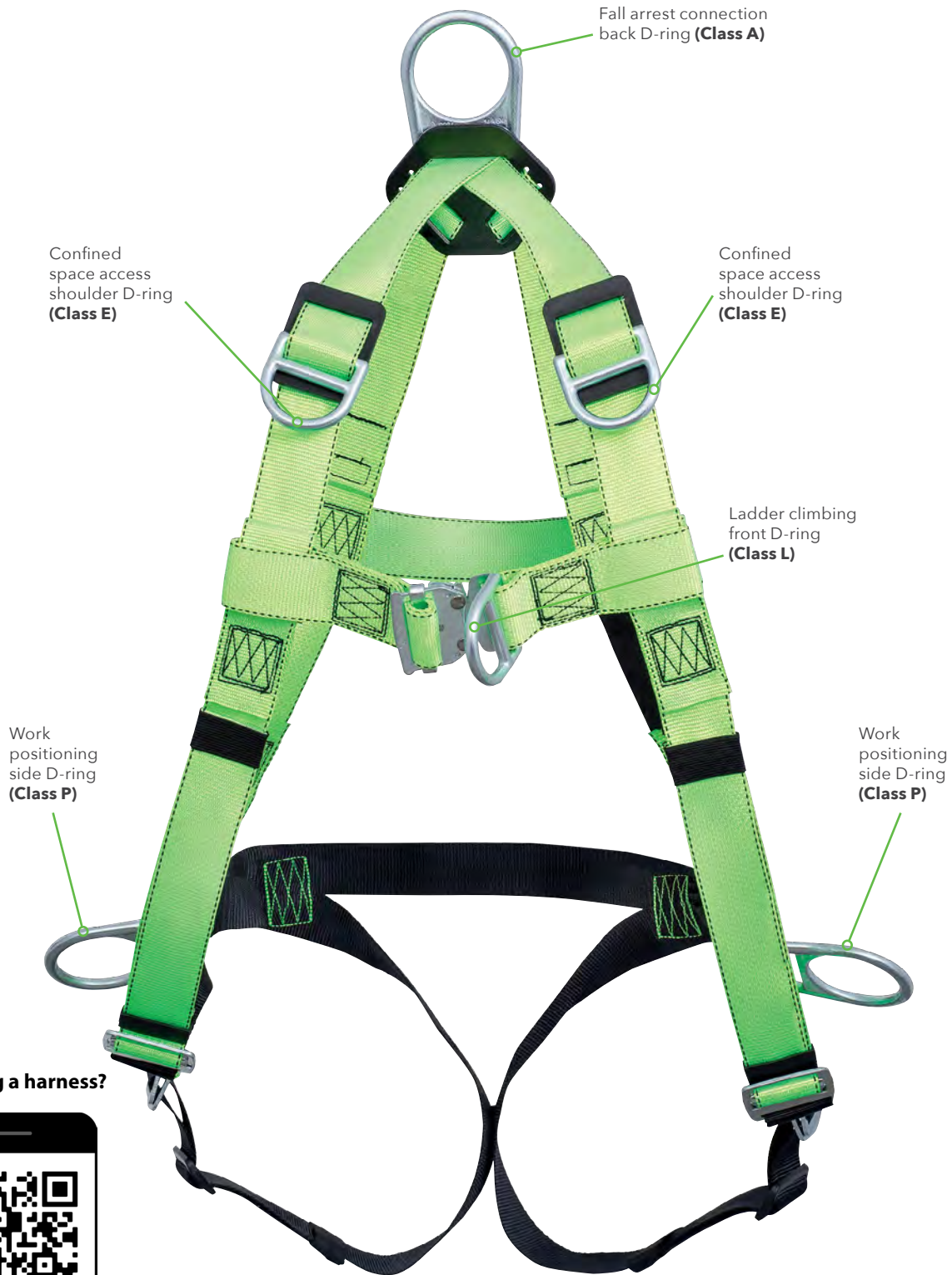

Donning a harness?



V8002060



FULL-BODY HARNESSES

Reference Guide

Third Party Certification



PeakWorks offers four series of harnesses: PeakPro Plus, PeakPro, Contractor, and Compliance.

- Certified to both **ANSI Z359.11** and **CSA Z259.10** standards
- Meets or exceeds all applicable OSHA standards
- 130 to 310 lb. (60 to 141kg) capacity (combined weight of person, tools, clothing, etc.)
- Sub-pelvic strap for added safety and support
- Fall indicator for easier inspection before use
- Polyester webbing



Example: V8005170
(FBH-70110G)



Example: V8255623
(FBH-60110A1020-L)

PEAKPRO PLUS



- Peek-a-boo webbing has wear indicator for simple inspection
- Hi-vis yellow top and black bottom, easily visible and distinguishable for ease of donning
- Five points of adjustment ensuring a good fit (two leg, two torso, one chest)
- Buckles: premium Stab Lock (chest), Stab Lock (legs)
- Premium padded shoulder, back and leg straps for all-day comfort
- Anodized aluminum hardware for reduced weight and no corrosion
- Includes installed trauma straps at no additional cost
- Includes integrated padded belt

PEAKPRO



- Hi-vis green top and black bottom, easily visible and distinguishable for ease of donning
- Five points of adjustment ensuring a good fit (two leg, two torso, one chest)
- Buckles: premium Stab Lock (chest), Stab Lock (legs) or grommets (legs)
- Padded shoulder, back and leg straps for all-day comfort
- Includes installed trauma straps
- Available as harness & belt combo or just the harness.

FULL-BODY HARNESSSES

Reference Guide (continued)



Example: V8002000 (FBH-10000A)



Example: V8001000 (FBH-10002A)

CONTRACTOR



- Hi-vis green top and black bottom, easily visible and distinguishable for ease of donning
- Five points of adjustment ensure a good fit (two leg, two torso, one chest)
- Buckles: Pass-thru (chest and legs), pass-thru or grommets (legs)

COMPLIANCE



- Hi-vis green
- Three points of adjustment ensuring a good fit (two leg, one chest)
- Buckles: Pass-thru (chest and legs)



FULL-BODY HARNESSES

PeakPro Plus Series



NEW!

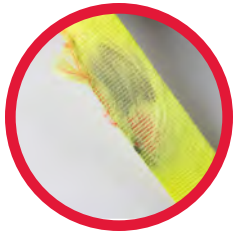

Specially designed peek-a-boo webbing shows red indicator in case of damage or wear



Premium padding on the shoulders, back, and legs

Lanyard parks

Integrated trauma straps allow standing position and improved circulation in the legs

Reinforced padded lumbar support

Padded leg straps add comfort and absorbs force during a fall

Aluminum hardware provides corrosion resistance and reduced weight

Belt sizing chart:

Size	Min.	Max.
S	32" (81.3cm)	40" (1.02m)
M	36" (91.4cm)	44" (1.11m)
L	42" (1.07m)	48" (1.22m)
XL	44" (1.11m)	52" (1.32m)
XXL	48" (1.22m)	56" (1.42m)

PeakPro Plus Harness



PEAKPRO PLUS HARNESS – SUPER PREMIUM SUPREME COMFORT • FIT • SAFETY • PERFORMANCE

FULL-BODY HARNESSSES

PeakPro Plus Series



The PeakWorks PeakPro Plus Harness is a sure-fit full body harness, Class APE, with increased durability and comfort. All hardware components are made from high-grade anodized aluminum for reduced weight and no risk of corrosion for added life expectancy.



- Material: Polyester “peek-a-boo” webbing — when you see red, it’s time to replace the harness
- Premium padding on the shoulders, back and legs
- Super-lightweight, anodized aluminum hardware
- Reinforced padded lumbar support belt for all-day comfort
- Supreme comfort, fit, and safety
- Chest Buckles: Aluminum Stab Lock
- Leg Buckles: Aluminum Stab Lock
- Weight: 3 lbs. (1.4kg)
- Class A, Class AP, Class APE available
- Certified to **CSA Z259.10** and **ANSI Z359.11**



V800517X
Front



V800517X
Back

PRODUCT NO.	MODEL NO.	Size	Weight Capacity	Trauma Straps	Class	Harness Weight	BUCKLE TYPE			D-RING LOCATION			
							Chest	Legs	Torso	Back	Sides	Front	Shoulders
V8005101	FBH-70110A-S	S	130 to 310 lbs. (60 to 141kg)	Yes	Class A	2.3 lbs (1kg)	Stab Lock	Stab Lock	Friction	1			
V8005102	FBH-70110A-M	M	130 to 310 lbs. (60 to 141kg)	Yes	Class A	2.3 lbs (1kg)	Stab Lock	Stab Lock	Friction	1			
V8005103	FBH-70110A-L	L	130 to 310 lbs. (60 to 141kg)	Yes	Class A	2.3 lbs (1kg)	Stab Lock	Stab Lock	Friction	1			
V8005104	FBH-70110A-XL	XL	130 to 310 lbs. (60 to 141kg)	Yes	Class A	2.5 lbs (1.1kg)	Stab Lock	Stab Lock	Friction	1			
V8005105	FBH-70110A-XXL	XXL	130 to 310 lbs. (60 to 141kg)	Yes	Class A	2.6 lbs (1.1kg)	Stab Lock	Stab Lock	Friction	1			
V8005111	FBH-70110B-S	S	130 to 310 lbs. (60 to 141kg)	Yes	Class AP	2.5 lbs (1.1kg)	Stab Lock	Stab Lock	Friction	1	2		
V8005112	FBH-70110B-M	M	130 to 310 lbs. (60 to 141kg)	Yes	Class AP	2.5 lbs (1.1kg)	Stab Lock	Stab Lock	Friction	1	2		
V8005113	FBH-70110B-L	L	130 to 310 lbs. (60 to 141kg)	Yes	Class AP	2.8 lbs. (1.3kg)	Stab Lock	Stab Lock	Friction	1	2		
V8005114	FBH-70110B-XL	XL	130 to 310 lbs. (60 to 141kg)	Yes	Class AP	2.9 lbs. (1.3kg)	Stab Lock	Stab Lock	Friction	1	2		
V8005115	FBH-70110B-XXL	XXL	130 to 310 lbs. (60 to 141kg)	Yes	Class AP	2.9 lbs. (1.3kg)	Stab Lock	Stab Lock	Friction	1	2		
V8005171	FBH-70110G-S	S	130 to 310 lbs. (60 to 141kg)	Yes	Class APE	3 lbs. (1.4kg)	Stab Lock	Stab Lock		1	2		2
V8005172	FBH-70110G-M	M	130 to 310 lbs. (60 to 141kg)	Yes	Class APE	3 lbs. (1.4kg)	Stab Lock	Stab Lock		1	2		2
V8005173	FBH-70110G-L	L	130 to 310 lbs. (60 to 141kg)	Yes	Class APE	3 lbs. (1.4kg)	Stab Lock	Stab Lock		1	2		2
V8005174	FBH-70110G-XL	XL	130 to 310 lbs. (60 to 141kg)	Yes	Class APE	3 lbs. (1.4kg)	Stab Lock	Stab Lock		1	2		2
V8005175	FBH-70110G-XXL	XXL	130 to 310 lbs. (60 to 141kg)	Yes	Class APE	3 lbs. (1.4kg)	Stab Lock	Stab Lock		1	2		2



FULL-BODY HARNESSES

PeakPro Series



Lanyard parks

One size fits most users

Available with belt combo or can be added/removed



Premium padding on the back, shoulders, and legs

Label cover

Trauma straps

Padded leg straps add comfort and absorbs force during a fall

V8005101

PEAKPRO HARNESS — PREMIUM COMFORT • FIT • SAFETY • PERFORMANCE

FULL-BODY HARNESSES/BELT COMBOS

PeakPro Series



The PeakWorks PeakPro Series harness is our gold standard harness. With its legendary comfort, this harness can be worn comfortably all day long when working at heights.

- High visibility color
- Fully adjustable for a universal fit
- Fall indicator for easier inspection before use
- Large back D-ring for easy connection
- Available in a variety of classes: A, AP, AL
- Meets or exceeds all applicable OSHA standards
- Polyester webbing
- 130 to 310 lb. (60 to 141kg) capacity (combined weight of person, tools, clothing, etc.)
- Certified to both **ANSI Z359.11** and **CSA Z259.10** standards



PeakPro harnesses now include two lanyard parks for easy storage



Belt sizing chart:

Size	Min.	Max.
S	32" (81.3cm)	40" (1.02m)
M	36" (91.4cm)	44" (1.11m)
L	42" (1.07m)	48" (1.22m)
XL	44" (1.11m)	52" (1.32m)
XXL	48" (1.22m)	56" (1.42m)

PeakPro Series Harnesses include Trauma Straps!



V825562X
FBH60110A1020-X

PRODUCT NO.	MODEL NO.	Size	Trauma Straps	Class	Harness Weight	BUCKLE TYPE			D-RING LOCATION			
						Chest	Legs	Torso	Back	Sides	Front	Shoulders
V8255621	FBH60110A10201	S	Yes	Class AP	3.5 lbs (1.6 kg)	Stab Lock	Stab Lock	Friction	1	2		
V8255622	FBH60110A10202	M	Yes	Class AP	3.5 lbs (1.6 kg)	Stab Lock	Stab Lock	Friction	1	2		
V8255623	FBH60110A10203	L	Yes	Class AP	3.5 lbs (1.6 kg)	Stab Lock	Stab Lock	Friction	1	2		
V8255624	FBH60110A10204	XL	Yes	Class AP	3.5 lbs (1.6 kg)	Stab Lock	Stab Lock	Friction	1	2		
V8255625	FBH60110A10205	XXL	Yes	Class AP	3.5 lbs (1.6 kg)	Stab Lock	Stab Lock	Friction	1	2		



FULL-BODY HARNESSES



PeakPro Series



The PeakWorks PeakPro Series harness is our gold standard harness. With its legendary comfort, this harness can be worn comfortably all day long when working at heights.

- High visibility color
- Fully adjustable for a universal fit
- Fall indicator for easier inspection before use
- Large back D-ring for easy connection
- Available in a variety of classes: A, AP, AL
- Meets or exceeds all applicable OSHA standards
- Polyester webbing
- 130 to 310 lb. (60 to 141kg) capacity (combined weight of person, tools, clothing, etc.)
- Certified to both **ANSI Z359.11** and **CSA Z259.10** standards



V8006100
FBH-60110A



V8006110
FBH-60110B

PRODUCT NO.	MODEL NO.	Trauma Straps	Class	Harness Weight	BUCKLE TYPE			D-RING LOCATION			
					Chest	Legs	Torso	Back	Sides	Front	Shoulders
V8006100	FBH-60110A	Yes	Class A	3.5 lbs.(1.6kg)	Stab Lock	Stab Lock	Friction	1			
V8006110	FBH-60110B	Yes	Class AP	4 lbs.(1.8kg)	Stab Lock	Stab Lock	Friction	1	2		
V8006160	FBH-60110APL	Yes	Class ALP	4.7 lbs (2kg)	Stab Lock	Stab Lock	Friction	1	2	1	

FULL-BODY HARNESSSES

PeakPro Series

BEST



**UNIVERSAL
FIT – ONE SIZE
FITS MOST
USERS!**



PeakPro harnesses now include two lanyard parks for easy storage



V8006120
FBH-60110L



PeakPro Series Harnesses include Trauma Straps!



V8006200
FBH-60120A



V8006210
FBH-60120B

PRODUCT NO.	MODEL NO.	Size	Weight Capacity	Trauma Straps	Class	Harness Weight	BUCKLE TYPE			D-RING LOCATION			
							Chest	Legs	Torso	Back	Sides	Front	Shoulders
V8006120	FBH-60110L	Universal	130 to 310 lbs. (60 to 141kg)	Yes	Class AL	4 lbs. (1.8kg)	Stab Lock	Stab Lock	Friction	1		1	
V8006200	FBH-60120A	Universal	130 to 310 lbs. (60 to 141kg)	Yes	Class A	3.5 lbs. (1.6kg)	Stab Lock	Grommet	Friction	1			
V8006210	FBH-60120B	Universal	130 to 310 lbs. (60 to 141kg)	Yes	Class AP	4.5 lbs. (2kg)	Stab Lock	Grommet	Friction	1	2		



FULL-BODY HARNESSES

Contractor Series



Lanyard parks

Hi-visibility green webbing

Label cover protects labels from environment

Available with harness and belt combo; belt is sold separately and can be added/removed



V825521X



Available with or without padded belt

CONTRACTOR HARNESS — PERFORMANCE SERIES

FULL-BODY HARNESSES/BELT COMBOS

Contractor Series



- Contractor series harnesses are as lightweight as it gets for all-day comfort
- High-visibility color
- Five-point adjustable for a universal fit
- Available with or with out belt. Belt can be added and removed.
- Two lanyard parks on chest strap for easy storage of lanyard
- Fall indicator for easier inspection before use
- 130 to 310 lbs. capacity (60 to 141kg)
- Certified to both **ANSI Z359.11** and **CSA Z259.10**



All Contractor harnesses now include two lanyard parks for easy storage



V825521X
FBH10020A1020X



V825522X
FBH10000A1020X

PRODUCT NO.	MODEL NO.	Size	Trauma Straps	Class	Harness Weight	BUCKLE TYPE			D-RING LOCATION			
						Chest	Legs	Torso	Back	Sides	Front	Shoulders
V825521X	FBH10020A1020X	S, M, L, XL, XXL	No	Class AP	3 lbs (1.4kg)	Pass-Thru	Grommet	Friction	1	2		
V825522X	FBH10000A1020X	S, M, L, XL, XXL	No	Class AP	2.5 lbs (1.1 kg)	Pass-Thru	Pass-Thru	Friction	1	2		



FULL-BODY HARNESSES



Contractor Series



- Contractor series harnesses are as lightweight as it gets for all-day comfort
- High-visibility color
- Five-point adjustable for a universal fit
- Available with or without a belt. Belt can be added and removed.
- Two lanyard parks on chest strap for easy storage of lanyard
- Fall indicator for easier inspection before use
- 130 to 310 lbs. capacity (60 to 141kg)
- Certified to both **ANSI Z359.11** and **CSA Z259.10**



Contractor harnesses now include two lanyard parks for easy storage



V8002000
FBH-10000A



V8002210
FBH-10020B

PRODUCT NO.	MODEL NO.	Size	Trauma Straps	Class	Harness Weight	BUCKLE TYPE			D-RING LOCATION			
						Chest	Legs	Torso	Back	Sides	Front	Shoulders
V8002000	FBH-10000A	Universal	No	Class A	2.5 lbs. (1.1kg)	Pass-Thru	Pass-Thru	Friction	1			
V8002010	FBH-10000B	Universal	No	Class AP	3 lbs. (1.4kg)	Pass-Thru	Pass-Thru	Friction	1	2		
V8002200	FBH-10020A	Universal	No	Class A	3 lbs. (1.4kg)	Pass-Thru	Grommet	Friction	1			
V8002210	FBH-10020B	Universal	No	Class AP	3.5 lbs. (1.6kg)	Pass-Thru	Grommet	Friction	1	2		
V8002230	FBH-10020E	Universal	No	Class AE	3.5 lbs. (1.6kg)	Pass-Thru	Grommet	Friction	1			2

FULL-BODY HARNESSSES

Contractor Series



UNIVERSAL FIT – ONE SIZE FITS MOST USERS!

NEW
MADE WITH
Hi-Vis
MATERIALS



V8008000
FBH-10000AHV



V8002020
FBH-10000L



V8002030
FBH-10020E

PRODUCT NO.	MODEL NO.	Size	Trauma Straps	Class	Harness Weight	BUCKLE TYPE			D-RING LOCATION			
						Chest	Legs	Torso	Back	Sides	Front	Shoulders
V8008000	FBH-10000AHV	Universal	No	Class A	2.5 lbs. (1.4kg)	Pass-Thru	Pass-Thru	Friction	1			
V8002020	FBH-10000L	Universal	No	Class AL	3.5 lbs. (1.6kg)	Stab-Lock	Pass-Thru	Friction	1		1	
V8002030	FBH-10000E	Universal	No	Class AE	3 lbs. (1.4kg)	Pass-Thru	Pass-Thru	Friction	1			2



FULL-BODY HARNESSES

GOOD**

Compliance Series



Contractor harnesses now include two lanyard parks for easy storage

The PeakWorks Compliance Series harness is the best value on the market. When compliance and price are the key drivers, this harness is the solution.

- High visibility color
- Three points of adjustment ensuring a good fit (two leg, one chest)
- Two lanyard parks on chest strap for easy storage of lanyard
- Pass-thru leg and chest buckles for quick donning
- Sub-pelvic strap for added safety and support
- Fall indicator for easier inspection before use
- Large back D-ring for easy connection
- Polyester webbing
- 130 to 310 lb. (60 to 141kg) capacity (combined weight of person, tools, clothing, etc.)
- Certified to both **ANSI Z359.11** and **CSA Z259.10** standards
- Meets or exceeds all applicable **OSHA** standards



V8001000
FBH-10002A



V8001200
FBH-10022A

PRODUCT NO.	MODEL NO.	Size	Trauma Straps	Class	Harness Weight	BUCKLE TYPE			D-RING LOCATION			
						Chest	Legs	Torso	Back	Sides	Front	Shoulders
V8001000	FBH-10002A	Universal	No	Class A	2 lbs (0.9kg)	Pass-Thru	Pass-Thru	N/A	1			
V8001200	FBH-10022A	Universal	No	Class A	2.2 lbs (1kg)	Pass-Thru	Grommet	N/A	1			

FULL-BODY HARNESES – SPECIALTY ARC FLASH

Welding and Arc Flash Harness

- Kevlar® webbing resists high temperatures and is designed to withstand harsh welding environments
- Five points of adjustment (two leg, two torso, one chest) for custom fit
- Upgraded Stab Lock leg and chest buckles for quick donning and comfort
- Large fall arrest D-ring for easy lanyard connection
- Side D-rings for added versatility
- Fall indicator for convenient pre-use inspection
- Certified to **ANSI Z359.11, CSA Z259.10, ASTM F887-13**, and meets the revised **OSHA 1910.269** standard for arc flash exposure up to 40 cal/cm²



V8009010
FBH 121102B



NEW!
WELDER'S
HARNESS!

PRODUCT NO.	MODEL NO.	Size	Weight Capacity	Class	Harness Weight	BUCKLE TYPE			D-RING LOCATION			
						Chest	Legs	Torso	Back	Sides	Front	Shoulders
V8009010	FBH-121102B	Universal	130 to 310 lbs. (60 to 141kg)	Class AP	4 lbs. (1.8kg)	Stab Lock	Stab Lock		1	2		

Welder's Shock Absorbing Lanyards

- Partially Oriented Yarn (POY) material stretches and is encased in tubular webbing for maximum strength
- Kevlar® webbing protects against welding spatter and resists high temperatures
- Drop indicator for easier inspection before use
- Designed for a 6' fall with a capacity of 130 to 310 lbs.
- Certified to **ANSI Z359.13, ASTM F887-13**, and **OSHA 1910.269/1926954** standards

PRODUCT NO.	MODEL NO.	Material	Length	Deployed Length	Average Arrest Force	Body	Anchor	Weight
V8109506	SA-1700-6	Kevlar w/ POY core	6' (1.82m)	10' (3m)	900 lbs. (408kg)	Snap	Snap	2.5 lbs. (1.1kg)
V8109526	SA-1702-6	Kevlar w/ POY core	6' (1.82m)	10' (3m)	900 lbs. (408kg)	Snap	Form	2.5 lbs. (1.1kg)



V8109526
SA-1702-6



V8109506
SA-1700-6



V805101X
WB-1010-X



V805601X
WB-6010-X



V805602X
WB-6020-X



V8059
WB-6006



V860301
FBH-PAD



V860302
CP-14010

BELTS AND ACCESSORIES

The PeakWorks series of belts add versatility and productivity to any PeakWorks harness.

- Lightweight for worker comfort
- Fits all PeakWorks harnesses
- Padded lumbar support made from closed cell foam
- Plated grommets for improved corrosion resistance
- Polyester webbing



Tongue Buckle



D-Ring

Belt sizing chart:

Size	Min.	Max.
S	32" (81.3cm)	40" (1.02m)
M	36" (91.4cm)	44" (1.11m)
L	42" (1.07m)	48" (1.22m)
XL	44" (1.11m)	52" (1.32m)
XXL	48" (1.22m)	56" (1.42m)

PRODUCT NO. (see table below)	MODEL NO.	Size (X)	Product Name	Padded Lumbar	D-Ring Location	
					Back	Sides
V805101X	WB-1010-X	S, M, L, XL, XXL	Restraint Belt		1	
V805601X	WB-6010-X	S, M, L, XL, XXL	PeakPro Restraint Belt with Padded Lumbar Support	Y	1	
V805602X	WB-6020-X	S, M, L, XL, XXL	PeakPro Positioning Belt with Padded Lumbar Support	Y		2
V8059	WB-6006	Universal	Padded Lumbar Support for Belt			

When ordering a belt, **PRODUCT NO. X** refers to the product size; for example:

Size	PRODUCT NO.	MODEL NO.
S	V8051011	WB-1010-S
M	V8051012	WB-1010-M
L	V8051013	WB-1010-L
XL	V8051014	WB-1010-XL
XXL	V8051015	WB-1010-XXL

Accessories can be added to any PeakWorks harness.

PRODUCT NO.	MODEL NO.	Product Name
V860301	FBH-PAD	Removable Back Pad for PW Harnesses
V860302	CP-14010	D-Ring Extender 18" (46cm)
V860308	CP-14010	D-Ring Extender 8" (20cm)

Accessorize Your Harness!

TRAUMA STRAPS

- In the event of a fall, trauma straps help reduce the effects of suspension trauma
- Trauma straps can be added to any PeakWorks® full body harness
- Trauma straps are an important part of any rescue plan

How to Use Trauma Straps

- Pull the straps out of their packs
- Clip the straps together
- Step into the straps

Orthostatic Intolerance or Suspension Trauma

- Blood can accumulate in the veins while in a sedentary position
- Reduction in quantity and/or quality (O₂) of blood flowing to the brain and kidneys
- May be fatal

Suspension Trauma Signs and Symptoms

- Faintness
- Breathlessness
- Sweating
- Paleness
- Hot flashes
- Increased heart rate
- Nausea
- Dizziness
- Unusually low heart rate
- Unusually low blood pressure
- Graying loss of vision

**HELPS TO
PROVIDE PROPER
CIRCULATION
WHILE AWAITING
RESCUE**



PRODUCT NO.	MODEL NO.	Product Name
V860303	CP-23300-1	Trauma Strap



V860303
CP-23300-1

How to Use Trauma Straps





PEAKWORKS™

**SELF-RETRACTING
LIFELINES**

**REACH YOUR
PEAK SAFETY
PERFORMANCE**

SELF-RETRACTING LIFELINES (SRLs)

Choosing the Right Self-Retracting Lifeline



There are different styles of SRLs that can be used for different applications. It is important to consider the specific application when choosing an SRL. Knowing the type of work environment, where the attachment point of the SRL is located on the job site, what the worker will be doing at heights and the required location of the fall protection will be crucial information to choosing the correct SRL. Below are questions to consider when choosing the appropriate SRL edge and where a fall hazard exists that could cause the lifeline to come into contact with the edge; for example, when working over structural steel or in high-rise concrete buildings under construction with open flooring.

Will the Installation of the SRL be Overhead (Vertical) or at Horizontal/Foot-Level (LE)?



Horizontal/Foot-Level (LE)

- If there is no anchorage point overhead to connect an SRL, you will likely be connecting at foot level or horizontally, also known as leading edge (LE) application
- A leading edge can be described as any sharp edge commonly found on a work site with which a cable or webbing connection could come into direct contact during a fall
- An SRL-LE device is an SRL that has enhanced design features for use in leading edge applications and must always be used for any leading edge application

Vertical (non-LE)

If the installation will be overhead or at shoulder level, you should determine the minimum fall clearance requirement on the job site to help identify the correct class of SRL you should be using. ANSI Z359 classifies an SRL as a CLASS A or CLASS B with the differences in arresting distances and average arrest forces indicated in the image below.

The extra 2-1/2 feet difference in arresting distance between ANSI Class A and B is a critical factor if you only have 6 feet fall clearance from the lower level (danger level).

Allowable Edges on Your SRL-LE Device?

- ANSI Z359 standard only requires leading edge testing over a steel sharp edge with radius of .005 inches to classify an SRL as leading edge approved. (Identified by the global sharp edge symbol below)
- ANSI Z359.14 standard does not cover testing over additional materials commonly found on many job sites, such as concrete edges, wood edges, paneled rounded fascia
- It is important to be aware of additional edge materials that the lifeline might come in to contact with and verify if the SRL-LE can be used in that application with the manufacturer

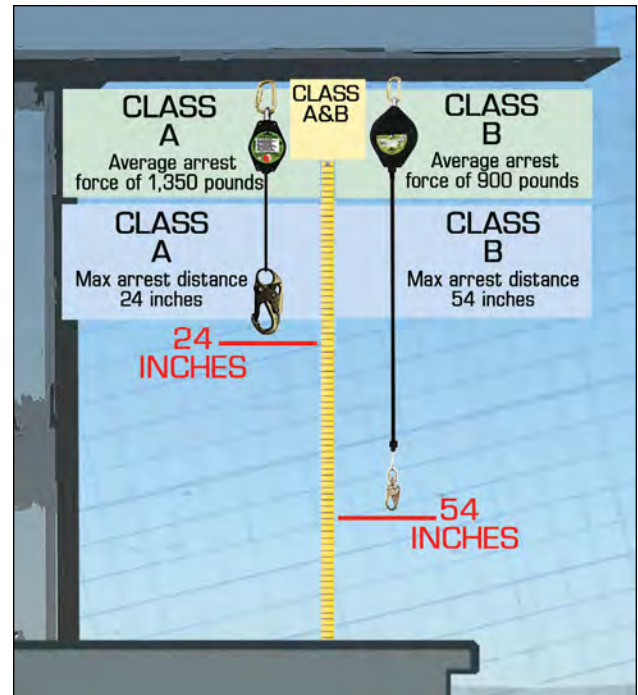

Global Sharp Edge symbol – Radius as sharp as .005 in. (.13mm)



SELF-RETRACTING LIFELINES (SRLs)

Peakworks SRL-LE Clear Advantage

One Device for Both Applications

- PeakWorks offers one device that is certified as ANSI Z359.14 CLASS A in vertical non-LE applications as well as leading edge certified for use in horizontal applications. One product works for most applications
- Reduces inventory duplication and safety investment costs

Deceleration System

- Unlike most SRL-LE devices in the market, PeakWorks SRL-LE devices do not require an external shock pack in order to meet the leading-edge standards due to the exclusive internal braking system
- This translates to shorter arresting distances in both vertical and horizontal orientation (refer to page 263 for fall clearance comparison)

Allowable Edges

- PeakWorks SRL-LE devices have had additional testing over multiple leading-edge materials commonly found on job sites, such as concrete edges, wooden beams, paneled rounded fascias, and trapezoidal sheet metal
- Contact a PeakWorks representative for information on additional material testing

Dyneema® Webbing vs Cable

- PeakWorks SRD-LE units are up to 32% lighter than competitors' SRD-LE of equivalent length
- Thin webbing accommodates smaller housing design
- Outstanding versatility for use on multiple surface materials
- Dyneema® webbing is a proven LE-rated material

THE PEAKWORKS LE ADVANTAGE

- No shock pack required
- Reduces fall clearance by up to 4 feet!
- Certified for both vertical and horizontal applications
- Ultra lightweight!



V845526006LE

PeakWorks Leading Edge-rated devices can be identified with labels on the housing and lifeline

PeakWorks understands the importance of calculating the fall clearance, which is why we created an app for calculating fall clearances. Visit the App Store today to download it.



THE PEAKWORKS SRL-LE FALL CLEAR ADVANTAGE!

SRL FALL CLEARANCE COMPARISON

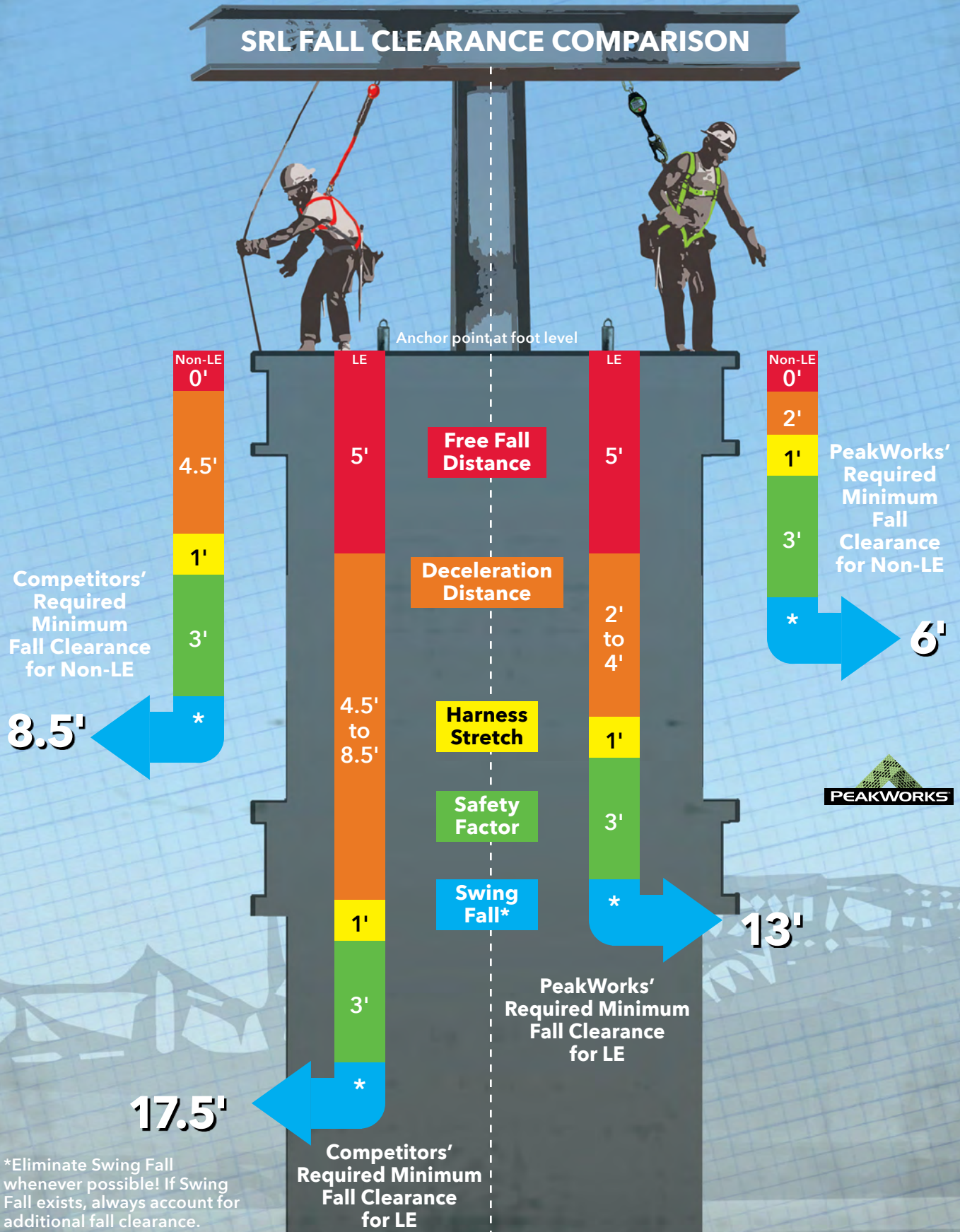

*Eliminate Swing Fall whenever possible! If Swing Fall exists, always account for additional fall clearance.



SELF-RETRACTING DEVICE (SRD) – LEADING EDGE

Dual Tie-Back LE



COMPACT UNIT

Among the smallest SRLs in the market. Designed for comfort and to reduce fatigue

Impact-resistant aluminum housing provides maximum durability compared to nylon or thermoplastic housing SRLs in the market

Internal automatic locking pawls will stop a fall within inches while keeping average arresting forces to 900 lbs. or less. Unlike competitor SRLs, no external shock pack is required on any of the PeakWorks SRLs as shock absorbers capability are built in to the internal braking mechanism

Tie-back snap hook with a 5,000 lb. gate strength and 0.83" (21mm) gate opening



Harness bracket allows for easy installation under the D-ring and provides a snug backpack-style fit. No separate carabiner required for harness connectivity on dual SRLs

Provides 360° rotation and leaves the harness dorsal D-ring open for rescue or other equipment attachment

Swivel top keeps the lifeline from tangling and twisting

6 ft. retractable lifeline reduces dragging and trip falls

Hi-visibility green Dyneema® webbing allows workers to easily inspect webbing for damage

3 ft. of abrasion-resistant outer jacket tie-back legs wrap around the anchor point, allowing the tie-back snap hook to tie back on to itself

Offers more mobility for workers allowing the tie-back leg to connect where traditional anchorage connectors are not available or feasible

Impact indicator provides visual inspection

V845528009TB

Using the correct snap hook on your SRL tie-back makes all the difference

PeakWorks designed the new Tie-Back with a special snap hook that will not accidentally open under gate load. Be sure to use approved Tie-Back gear that is certified to meet ANSI standards 5,000 lb. gate strength.



Tie-back hook
(3/4" (19mm) Gate opening)



Mini Form hook
(2" (51mm) Gate opening)



Snap Hook
(3/4" (19mm) Gate opening)

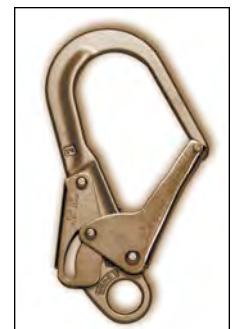

Form Hook
(2-1/2" (64mm) Gate opening)

SELF-RETRACTING DEVICE (SRD) – LEADING EDGE

Tie-Back SRD-LE – Class A

Tie-Back

- Tie-back is an all-in-one, self-retracting lifeline and anchorage connector, thus reducing the amount of equipment required on the job site and making it a cost-effective alternative
- It allows the unit to attach directly to a compatible structural anchor by wrapping around the structure to tie-back to itself
- Single and dual 100% tie-off configurations available
- **Approved for use in vertical and horizontal applications**
- LE minimum fall clearance: 13 ft. (4m)
- Maximum total arrest distance: 24 in. (0.61m) non-leading edge application
- Average arrest force: 765 lbf (3.4kN)
- LE minimum setback distance: 12 in. (0.31 m)
- Third-party certified to **ANSI Z359.14-2014, Class A and Leading Edge**, meets applicable **OSHA** standards



PRODUCT NO.	MODEL NO.	Webbing Width	Length	Weight	Capacity	Dual/Single
V845528009TB	SRL-54954-9TB	0.77" (20mm)	9 ft. (2.7m)	6 lbs. (2.7kg)	300 lbs. (136kg)	Dual
V845552T009TB	SRL-54T54-9TB	0.77" (20mm)	9 ft. (2.7m)	2.5 lbs. (1.1kg)	300 lbs. (136kg)	Single

INCREDIBLY LIGHTWEIGHT – CHECK AND COMPARE!



ONLY 6 LBS.!
BEST IN CLASS

V845528009TB (Dual Tie-Back)



ONLY 2.5 LBS.!
BEST IN CLASS

V845552T009TB (Single Tie-Back)



V8455277-5LE



V845525006LE



V845526006LE

SELF-RETRACTING DEVICE (SRD) – LEADING EDGE

Dual Compact SRD-LE – Class A

- Dual units are also available with lightweight aluminum rebar hooks
- Attachment points include a swivel eye on housing with connection pin for mounting below the dorsal D-ring
- Hi-vis green Dyneema® webbing lifeline has been sharp-edge tested over a .005" radius sharp edge
- Class A rating means the fall distance is less than 2 ft. (0.6m) or less when connected overhead (non-LE application)
- Leading edge minimum fall clearance of 13 ft. (4m) required
- Third-party certified to **ANSI Z359.14-2014, Class A** and **Leading Edge, CSA Z259.2.2**, meets applicable **OSHA** standards



PRODUCT NO.	MODEL NO.	Lifeline Type	Length	Weight	Capacity	Single/Dual	Hook Style
V8455277-5LE	SRL-54854-7-5LE	Dyneema® Webbing .77" (20mm)	7.5 ft. (2.3m)	6.2 lbs. (2.82kg)	300 lbs. (136kg)	Dual	Compact ladder hook (gate opening 2 in. (51mm))
V845525006LE	SRL-50502-6LE	Dyneema® webbing .77" (20mm)	6 ft. (1.8m)	5.5 lbs. (2.5kg)	300 lbs. (136kg)	Dual	Regular snap hook (gate opening .75 in. (19mm))
V845526006LE	SRL-50602-6LE	Dyneema® webbing .77" (20mm)	6 ft. (1.8m)	7.4 lbs. (3.36 kg)	300 lbs. (136kg)	Dual	Aluminum form hook (gate opening 2.5 in. (64mm))



SELF-RETRACTING DEVICE (SRD) – LEADING EDGE

Single SRD LE – Class A

Class A – Dyneema® Web

- Approved for use in vertical and horizontal applications
- LE minimum fall clearance: 13 ft. (4m)
- Maximum total arrest distance: 24 in. (0.61m) non-leading edge application
- Average arrest force: 765 lbf (3.4kN)
- Minimum setback distance: 12 in. (0.31 m)
- Foot level tie-off: Tested and approved for foot level tie-off
- Operating temperatures: -22°F to 122°F (-30°C to 50°C)
- Aluminum housing
- Under 2.5 lbs. total weight
- Steel snap hook with .75" (19mm) gate opening; different snap hook types available
- Double-locking steel carabiner with 3,600 lb. gate strength included for anchor connection
- Certified to meet **OSHA, ANSI Z359.14-2014, Class A, Leading Edge** and **CSA Z259.2.1** standards



PRODUCT NO.	MODEL NO.	Webbing Width	Length	Weight	Hook (Gate Opening)	Capacity
V845822006LE	SRL-65105-6LE	.75" (19mm) webbing	6 ft. (1.8m)	2.46 lbs. (1.12kg)	3/4" snap hook (19mm)	300 lbs. (136kg)

Class A – Cable

- Tested and approved for foot level tie-off
- Carabiner hook included for attachment to the anchor point or rear D-ring of the harness
- Available with regular snap hook or lightweight aluminum form hook
- Lightweight composite plastic housing
- 3/16" (5mm) galvanized cable, 10 ft. (3m) working length
- LE minimum fall clearance: 13 ft. (4m)
- Maximum total arrest distance: 24 in. (0.61m) non-leading edge application
- Average arrest force: 765 lbf (3.4kN)
- Minimum setback distance: 16 in. (0.4m)
- Third-party certified to **ANSI Z359.14-2014, Class A** and **Leading Edge, CSA Z259.2.2**, meets applicable **OSHA** standards

PRODUCT NO.	MODEL NO.	Cable Diameter	Length	Weight	Hook (Gate Opening)	Capacity
V845533010LE	SRL-53302-10LE	3/16" cable (5mm)	10 ft. (3m)	5.28 lbs. (2.4kg)	3/4" snap hook (19mm)	300 lbs. (136kg)
V845534010LE	SRL-53402-10LE	3/16" cable (5mm)	10 ft. (3m)	6.3 lbs. (2.9kg)	2-1/2" form hook (64mm)	300 lbs. (136kg)

QUICK NOTE

Selecting a Dual vs Single SRD?
Dual Self-Retracting Devices allow for 100% tie-off when moving or transitioning between levels or obstacles.



V845822006LE



V845533010LE



V845534010LE



V8455330XXLE
SRL-53302-XXLE

SRL-LE



SELF-RETRACTING LIFELINES (SRL) – LEADING EDGE

Class B – Cable

- Approved for use in vertical and horizontal applications
- Tested and approved for foot level tie-off
- Additional testing over alternate leading edge materials
- Carabiner hook included for attachment to anchor point
- Aluminum housing for maximum durability
- 3/16" (5mm) galvanized cable lifeline
- LE minimum fall clearance: 13 ft. (4m)
- Minimum set-back distance from edge: 20 in. (50cm); refer to user manual
- Maximum total arrest distance: 54 in. (1.4m) non-leading edge applications
- Average arrest force: 765 lbf (3.4kN)



PRODUCT NO.	MODEL NO.	Lifeline Type	Length	Weight	Hook Style	Capacity
V845533020LE	SRL-53302-20LE	3/16" (5mm) Cable	20' (6m)	7 lbs. (3 kg)	3/4" Snap Hook	300 lbs. (136kg)
V845533030LE	SRL-53302-30LE	3/16" (5mm) Cable	30' (9m)	10 lbs. (4.5kg)	3/4" Snap Hook	300 lbs. (136kg)
V845533040LE	SRL-53302-40LE	3/16" (5mm) Cable	40' (12m)	12 lbs. (5.4kg)	3/4" Snap Hook	300 lbs. (136kg)
V845533060LE	SRL-53302-60LE	3/16" (5mm) Cable	60' (18m)	16 lbs. (6.9kg)	3/4" Snap Hook	300 lbs. (136kg)



SELF-RETRACTING LIFELINES (SRL) – NON-LEADING EDGE

Class B – Dyneema® Web

- Approved for vertical use only, non-leading edge applications
- Easy and lightweight to carry
- High strength composite plastic housing
- Swivel top
- 1" (25mm) Dyneema® webbing
- Maximum total arrest distance: 54 in. (1.4m) non-leading edge applications



PRODUCT NO.	MODEL NO.	Lifeline Type	Length	Weight	Hook Style	Capacity
V845423012	SRL-40302-12	1" (25mm) Webbing	12' (3.5m)	2.6 lbs. (1.2 kg)	.75" Snap Hook	300 lbs. (136kg)
V845423018	SRL-40302-18	1" (25mm) Webbing	18' (5.5m)	2.6 lbs. (1.2 kg)	.75" Snap Hook	300 lbs. (136kg)



V8454230XX
SRL-40302-XX

SELF-RETRACTING LIFELINES (SRL) – NON-LEADING EDGE

Class B – Cable

- Approved for vertical use only, non-leading edge applications
- Aluminum housing for maximum durability
- 3/16" (5mm) galvanized cable lifeline
- Fixed handle anchor attachment point
- Maximum total arrest distance: 54 in. (1.4m) non-leading edge applications

PRODUCT NO.	MODEL NO.	Lifeline Type	Length	Weight	Hook Style	Capacity
V845533120	SRL-53302-120	3/16" (5mm) Cable	120' (36m)	42 lbs. (19.1 kg)	.75" Snap Hook	300 lbs. (136kg)
V845533140	SRL-53302-140	3/16" (5mm) Cable	140' (42m)	60 lbs. (27.3 kg)	.75" Snap Hook	300 lbs. (136kg)
V845533170	SRL-53302-170	3/16" (5mm) Cable	170' (51m)	75 lbs. (34.1 kg)	.75" Snap Hook	300 lbs. (136kg)



V8455331XX
SRL-53302-XXX



V8455340XX
SRL-53303-XX

SELF-RETRACTING LIFELINE (SRL-R) – RESCUE

3-Way Rescue/Recovery

- PeakWorks 3-Way Rescue and Retrieval SLR-R
- Transition from SRL mode to rescue and retrieval mode in seconds
- Aluminum housing for maximum durability
- 3/16" (5mm) galvanized cable lifeline
- Maximum total arrest distance: 54 in. (1.4m) non-leading edge applications

PRODUCT NO.	MODEL NO.	Lifeline Type	Length	Weight	Hook Style	Capacity
V845534060	SRL-53303-60	3/16" (5mm) Cable	60' (18m)	31 lbs. (14.1 kg)	.75" Snap Hook	310 lbs. (141kg)
V84553496	SRL-53303-96	3/16" (5mm) Cable	96' (29m)	48 lbs. (21.8 kg)	.75" Snap Hook	310 lbs. (141kg)
V845534140	SRL-53303-140	3/16" (5mm) Cable	140' (52m)	59 lbs. (26.8 kg)	.75" Snap Hook	310 lbs. (141kg)





LANYARDS

CONNECTING YOU SAFELY



LANYARDS

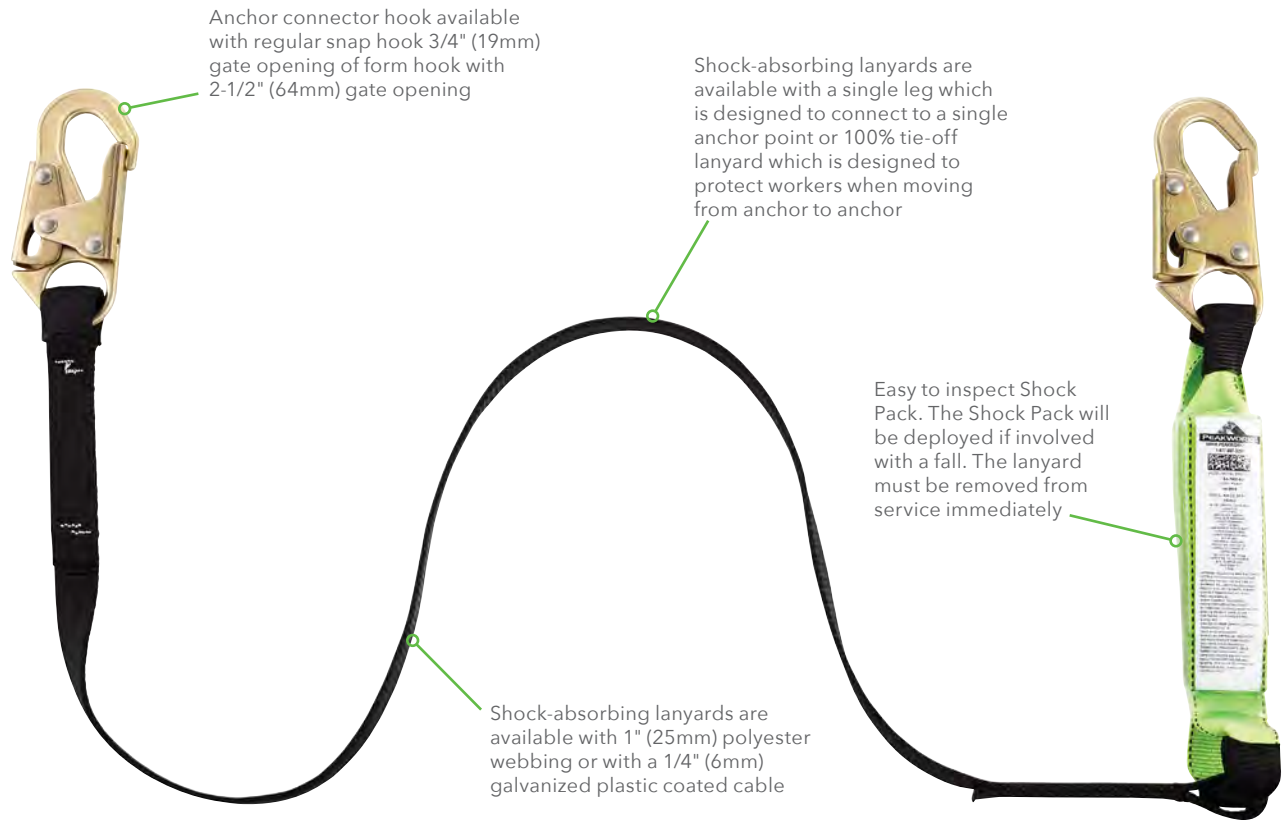

Anchor connector hook available with regular snap hook 3/4" (19mm) gate opening of form hook with 2-1/2" (64mm) gate opening

Shock-absorbing lanyards are available with a single leg which is designed to connect to a single anchor point or 100% tie-off lanyard which is designed to protect workers when moving from anchor to anchor

Easy to inspect Shock Pack. The Shock Pack will be deployed if involved with a fall. The lanyard must be removed from service immediately

Shock-absorbing lanyards are available with 1" (25mm) polyester webbing or with a 1/4" (6mm) galvanized plastic coated cable



Snap Hook
(3/4" (19mm) Gate Opening)



Form Hook
(2-1/2" (64mm) Gate Opening)

About Lanyards

- Lanyards are engineered products, and the critical connection component between the full body harness and the anchor. They are sometimes referred to as connectors
- PeakWorks lanyards are designed and tested to comply to strict CSA and ANSI standards
- There is a wide variety of lanyards to suit a wide range of applications
- There are two common types of lanyards: Fall Restraint and Fall Arrest

Fall Restraint Lanyards

- Fall restraint lanyards are a fixed-length connection and have no shock absorbing capability
- These lanyards are designed to limit the distance a worker can move from the anchor point and towards the edge of the structure and should never be used when there is a risk of falling

Fall Arrest Lanyards

- The shock absorbing action of these lanyards limits and reduces the force of a fall on the worker, significantly reducing injury to the body

SP (Shock Pack):

- SP (Shock Pack) lanyards are comprised of "tear webbing" which is woven in a manner that allows the webbing to tear when it has a load applied to it. This tearing absorbs a significant amount of downward force under load, reducing injury
- This tear webbing is folded and shrink-wrapped into a compact 1" x 2" x 6" (2.5cm x 5cm x 15cm) pack that is sewn into the lanyard next to the body connector
- Cable lanyards are ideal if you're working in abrasive or high-heat environments

SHOCK ABSORBING LANYARDS

Shock Pack (SP)



PeakWorks Shock Pack (SP) shock absorbing lanyards are certified to **ANSI Z359.13** standards.

- Made with a superior grade, heavy-duty 1-3/4" (45mm) or 1" (25mm) polyester webbing for maximum strength or 1/4" (6mm) galvanized plastic coated cable, with tear webbing shock absorber
- Resists abrasions and harmful UV rays
- Shock packs are designed to tear the inner webbing to reduce the force the worker feels to an acceptable level

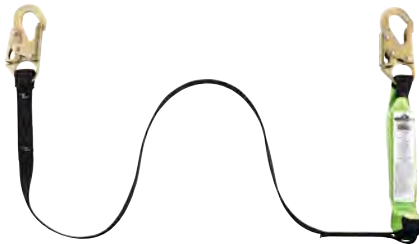

V810430X
SA-7400-6U



V8104326
SA-7402-6U



V8104356
SA-7405-6U

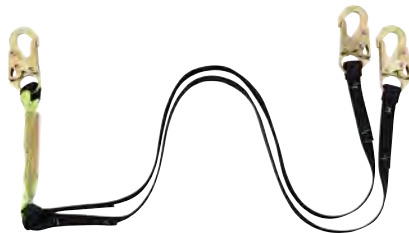

V8104406
SA-84000-6U



V8104426
SA-84022-6U



V8108426
SA-85522-6U

PRODUCT NO.	MODEL NO.	Style	Single or Double Leg	Weight Capacity	Body	Anchor 1	Anchor 2	Length X	Adjustable
V8104304	SA-7400-4U	Tear Pack 1" Webbing	Single	130 to 310 lbs.	Snap	Snap		4' (1.2m)	
V8104306	SA-7400-6U	Tear Pack 1" Webbing	Single	130 to 310 lbs.	Snap	Snap		6' (1.8m)	
V8104326	SA-7402-6U	Tear Pack 1" Webbing	Single	130 to 310 lbs.	Snap	Form		6' (1.8m)	
V8104300	SA-7400-6AU	Tear Pack 1" Webbing	Single	130 to 310 lbs.	Snap	Snap		6' (1.8m)	Yes
V8104320	SA-7402-6AU	Tear Pack 1" Webbing	Single	130 to 310 lbs.	Snap	Form		6' (1.8m)	Yes
V8104356	SA-7405-6U	Tear Pack 1" Webbing	Single	130 to 310 lbs.	Snap	Snap + D-ring		6' (1.8m)	
V8104406	SA-84000-6U	Tear Pack 1" Webbing	Double	130 to 310 lbs.	Snap	Snap	Snap	6' (1.8m)	
V8104426	SA-84022-6U	Tear Pack 1" Webbing	Double	130 to 310 lbs.	Snap	Form	Form	6' (1.8m)	
V8108306	SA-7500-6U	Tear Pack 1/4" PVC Coated Cable	Single	130 to 310 lbs.	Snap	Snap		6' (1.8m)	
V8108326	SA-7502-6U	Tear Pack 1/4" PVC Coated Cable	Single	130 to 310 lbs.	Snap	Form		6' (1.8m)	
V8108426	SA-85522-6U	Tear Pack 1/4" PVC Coated Cable	Double	130 to 310 lbs.	Snap	Form	Form	6' (1.8m)	

See page 263 for welder's lanyards



V81540X
LAN-3400-X



V81542X
LAN-3402-X



V815100X
LAN-1222-X



V815120X
LAN-1242-X



V860140
RA-100

RESTRAINT LANYARDS

Preventing a fall is a better way of protecting workers than arresting a fall. For these applications, PeakWorks has a wide selection of fall restraint lanyards. Fall restraint lanyards should never be used if there is any risk of falling.

- Fall restraint lanyards are a fixed length connection and have no shock absorbing capability
- These lanyards are designed to limit the distance a worker can move from the anchor point and towards the edge of the structure and should never be used when there is a risk of falling
- PeakWorks restraint lanyards are made using two types of material — a rugged heavy-duty polyester webbing or a premium polyester rope — and with a variety of hook configurations
- PeakWorks restraint lanyards are available in 4' (1.2m) and 6' (1.8m) lengths

PRODUCT NO.	MODEL NO.	Length	Product Name	Hook Type	
				Body	Anchor
V81540X	LAN-3400-X	4', 6' (1.2m, 1.8m)	Restraint Lanyard with 1" (25mm) Webbing	Snap	Snap
V81542X	LAN-3402-X	4', 6' (1.2m, 1.8m)	Restraint Lanyard with 1" (25mm) Webbing	Snap	Form
V815100X	LAN-1222-X	2', 3', 4', 5', 6' (.6m, .9m, 1.2m, 1.5m, 1.8m)	Restraint Lanyard with 5/8" (16mm) Rope	Snap	Snap
V815120X	LAN-1242-X	2', 3', 4', 5', 6' (.6m, .9m, 1.2m, 1.5m, 1.8m)	Restraint Lanyard with 5/8" (16mm) Rope	Snap	Form
V860140	RA-100	2' (.6m)	Rebar Chain Assembly	(2) Snap	Form





VERTICAL LIFELINES & ROPE GRABS

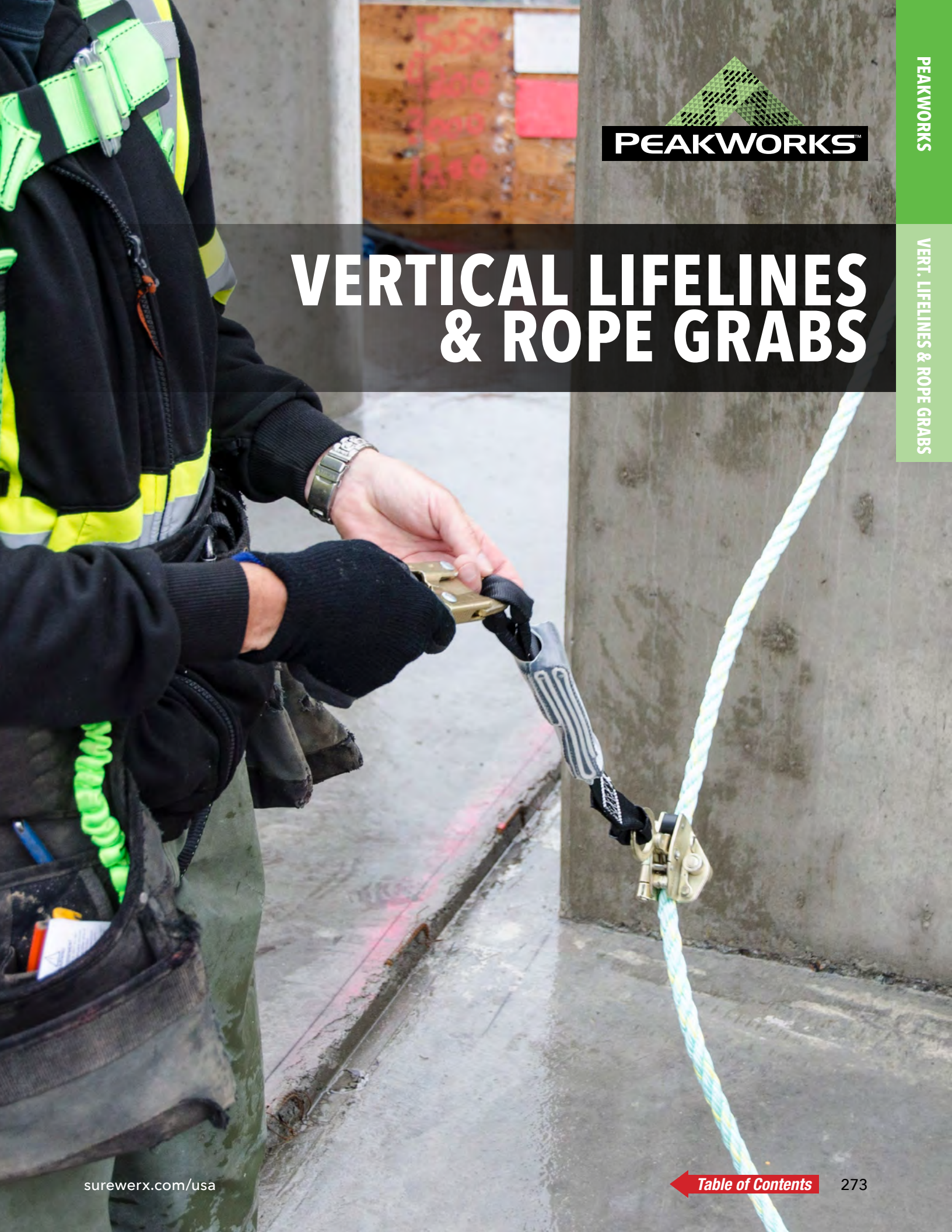



V84013XXX
VL-1115-X



V84014XXX
VL-1125-X



V84084XXX
VL-1825-X

VERTICAL LIFELINES & ROPE GRABS

Lifelines

- Lifelines are specially designed from rope made using high-strength polysteel
- Polysteel is an extruded co-polymer fibre that yields an extremely high-strength, lightweight rope with excellent resistance to acids and alkalis
- PeakWorks vertical lifelines are all 5/8" (16mm) in diameter
- Minimum breaking strength 6,000 lbs (27kN)
- We offer a wide range of lengths with a variety of snap hook/carabiner options
- All PeakWorks lifelines have a back splice at the trailing end to prevent the rope grab from coming off the end of the lifeline
- Certified to **CSA Z259.2.5-2012** and meets or exceeds **ANSI Z359.15** standards



PRODUCT NO.	MODEL NO.	Length	Product Name	End Configuration	
				Anchor End	Trailing End
V84013XXX	VL-1115-X	25', 50', 100' (7.6m, 15.2m, 30.5m)	Premium Vertical Lifeline, 5/8" (16mm) Rope	Carabiner	Back Splice
V84014XXX	VL-1125-X	25', 50', 100' (7.6m, 15.2m, 30.5m)	Premium Vertical Lifeline, 5/8" (16mm) Rope	Snap Hook	Back Splice
V84084XXX	VL-1825-X	25', 50', 100' (7.6m, 15.2m, 30.5m)	Standard Vertical Lifeline, 5/8" (16mm) Rope	Snap Hook	Back Splice

Note: other lengths available as a special order.

DID YOU KNOW?

Automatic rope grabs are designed to move easily up and down vertical lifelines hands-free to provide continuous fall protection. PeakWorks rope grabs include a shock-absorbing pack to reduce arresting forces in the event of a fall.

VERTICAL LIFELINES & ROPE GRABS

Rope Grabs

- Rope grabs are designed to travel hands-free on 5/8" (16mm) rope
- These automatic rope grabs follow the user during their ascent or descent
- In the event of a fall, the rope grab will "bite" onto the rope and arrest the user's fall
- PeakWorks rope grabs are also equipped with a panic lock feature which "bites" onto the rope even if the user mistakenly pushes the cam up, ensuring that the rope grab will lock and arrest the fall in any situation
- Rope grabs offer the most cost-effective fall protection solution when working at height
- 130 to 310 lb. (60 to 141kg) capacity (combined weight of person, tools, clothing, etc.)
- All Peakworks rope grabs meet or exceed **ANSI Z359.15** standards



V830103
RG-11015



V830113
RG-11005

PRODUCT NO.	MODEL NO.	Product Name	Rope	
			Size	Type
V830103	RG-11015	ADP Rope Grab with Panic Grab, Small Eye w/SP	5/8" (16mm)	3 Strand
V830113	RG-11005	ADP Rope Grab with Panic Grab, Large Eye w/SP	5/8" (16mm)	3 Strand

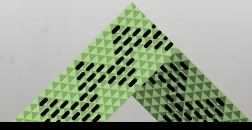

PEAKWORKS™

ANCHORAGE CONNECTORS

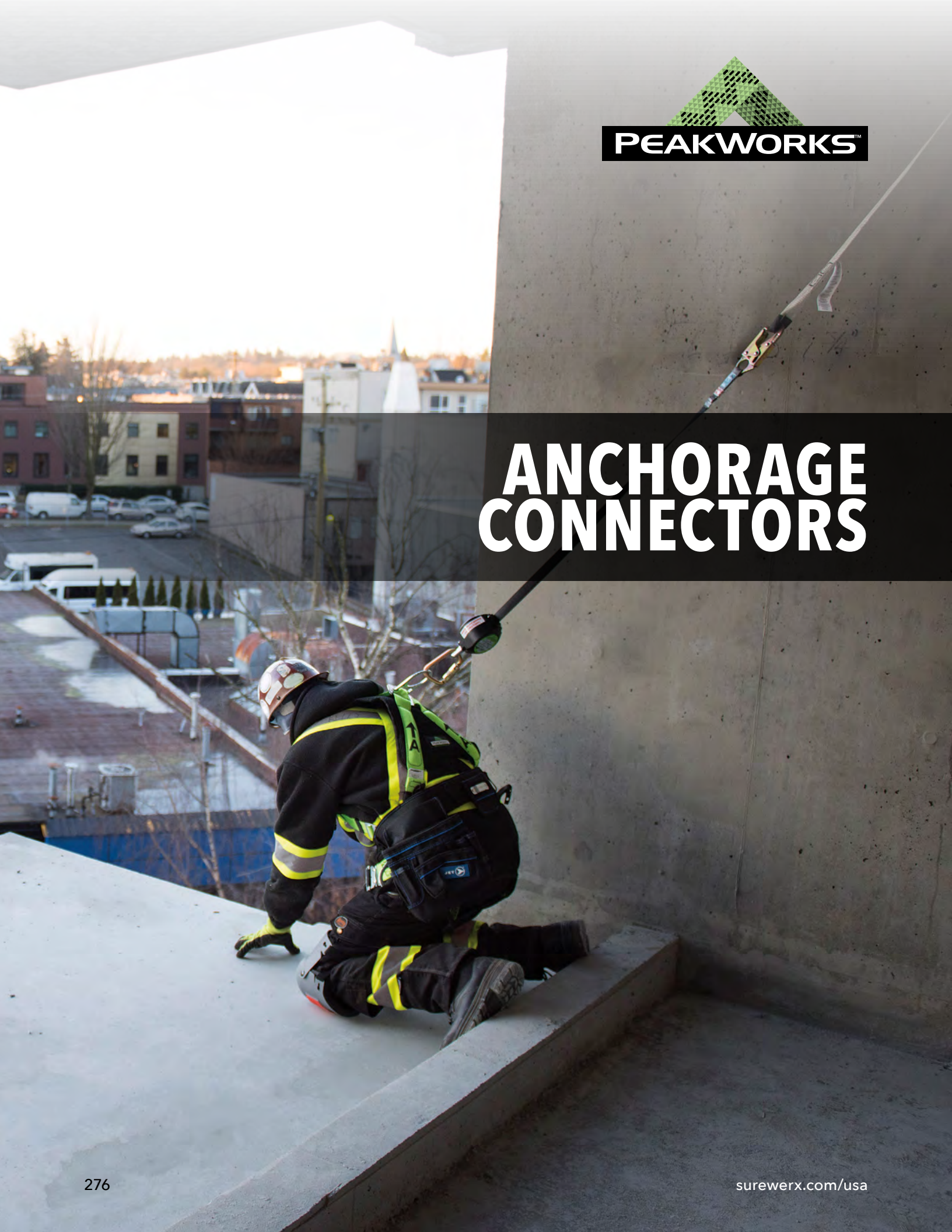

ANCHORAGE CONNECTORS

Anchors and Roof Brackets

- A complete fall arrest system requires three primary components: approved full body harness, connector and anchorage connector
- Anchors can be connected to a variety of materials such as steel, wood and concrete
- PeakWorks offers a wide range of anchor systems including: single-use/reusable roof anchors, sliding beam anchors, concrete hole anchors and permanent anchors
- The anchor should be located directly above the worker to prevent swinging
- The height of an anchor is a key variable when determining fall clearance
- As with all fall protection products, anchors must be inspected by a competent person at a minimum annually
- All PeakWorks anchors are built with a minimum tensile strength of 5,000 lbs (22 kN)
- All PeakWorks anchors meet or exceed **CSA Z259.15** and **ANSI Z359.18** standards and **OSHA** requirements
- 310 lb. (141kg) capacity for one worker (combined weight of person, tools, clothing, etc.)

PRODUCT NO.	MODEL NO.	Product Name	Application
V8221111	CP-10011-1	Permanent Anchorage with 1/2" (13mm) Hole	Permanent
V8221112	CP-10011-2	Permanent Anchorage with 5/8" (16mm) Hole	Permanent
V8221113	CP-10011-3	Permanent Anchorage with 3/4" (19mm) Hole	Permanent
V8229001	RB-9701	Single-Use Roof Bracket	Temporary
V8229100	RB-9800	Reusable Roof Anchor Bracket	Temporary
V8229104	RB-9900	Stainless Steel Reusable Roof Anchor Bracket	Temporary
V8221114	CP-10010-1	5K Concrete Swivel Anchor with 5/8" (16mm) Sleeve Anchor	Permanent
V8221115	CP-10010-2	5K Steel Swivel Anchor with 1/2" x 4" (13mm x 102mm) G8 Steel Bolt Lock Washer and Lock Nut	Permanent

DID YOU KNOW?

Anchors are built with a minimum tensile strength of 5,000 lbs (22kN) but will be limited to the integrity of the structure to which they are being attached. Verify the structure is properly evaluated before connecting the anchorage connector.



V822111X
CP-10011-X



V8229001
RB-9701



V8229100
RB-9800



V8229104
RB-9900



V8221114
CP-10010-1



V8221115
CP-10010-2



V8222130
CP-11010-1

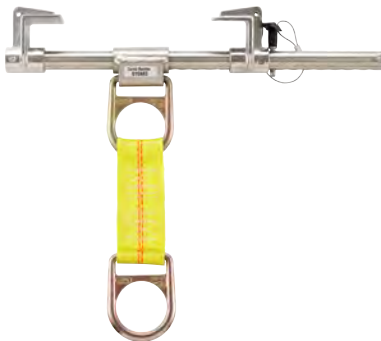

V8221131
AC-9450-SBAR

NEW!



V8222150
CP-11010-3

NEW!



V8222138
AC-9900-TROLLEY7

ANCHORAGE CONNECTORS

Overhead Beam Clamps

Overhead beam clamps are designed to attach to overhead structure without the aid of any tools. Simply adjust the size of the clamp to the bottom flange of the beam, lock it in place and its ready to go. The beam anchors provide a safe and practical solution to connecting to overhead beams. PeakWorks offers two styles of beam clamps.

- 1) Stationary – fixed in one location
- 2) Sliding – which can follow the worker to prevent a swing fall

Both beam clamps style models have a breaking strength of 5,000 lbs. (22kN)

PRODUCT NO.	MODEL NO.	Product Name	Size of Beam	Style
V8222130	CP-11010-1	Adjustable Sliding Beam Anchor	3.5" to 13.25" (88.9mm to 336.6mm)	Sliding
V8221131	AC-9450-SBAR	Sky Bar	3.5" to 12" (88.9mm to 304.8mm)	Stationary
V8222150	CP-11010-3	Aluminum Super Sliding Beam	3.5" to 12" (88.9mm to 304.8mm)	Sliding
V8222138	AC-9900-TROLLEY7	I-Beam Trolley	3" to 10" (76.2mm to 254mm)	Sliding

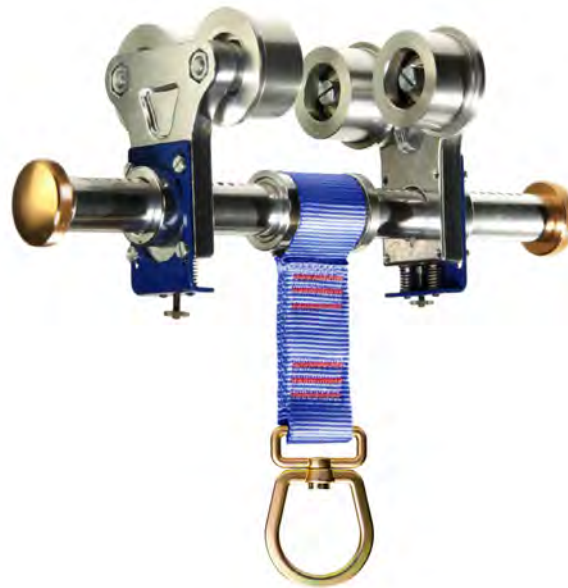

V8222138
AC-9900-TROLLEY7

I-Beam Trolley

- Designed to easily roll along over head I-beams while trailing the worker
- Can be removed and reused without any tools
- Easily adjust to various I-beam widths ranging from 3" to 10"
- ANSI Z359.18 and meets applicable OSHA standards for 5,000 lbf/22 kN

ANCHORAGE CONNECTORS

Drop-In/Drop-Thru Anchors

Removable Anchors

Removable anchors, developed for fall protection, are safe, lightweight, and surprisingly simple to employ. PeakWorks manufactures three styles of removable anchors

- 1) Drop-Thru Anchors
- 2) Concrete Anchors
- 3) Toggle Anchors

Drop-Thru Anchors

The Drop-Thru Anchor is a removable and reusable anchor designed for overhead applications. Available in three different sizes: 4", 6", and 12" diameter plates. Simply insert the cable end of the anchorage connector to an approved anchor and begin using it. Once the task is complete, pull the cable back through the opening and it's ready to be re-used.

Concrete Anchors

PeakWorks anchors have been tested to meet ANSI Z359.18. They have a long list of benefits above competitive products. A few include:

- Ease of use — simply drill the proper size hole into your concrete, blow the dust out with compressed air, and insert the unit
- Multi-directional attributes — PeakWorks removable anchors work in horizontal, vertical and overhead surfaces
- Reusability — when your job is done, simply fill in the drilled hole if necessary and reuse at your new desired location

Toggle Anchors

- Popular removable bolt anchor due to the portable and re-usable design
- Concrete anchorage connector can be used in variety of fall protection applications
- Breaking strength: 5,000 lbf/22kN
- Meets **ANSI Z359.18** and applicable **OSHA** standards

PRODUCT NO.	MODEL NO.	Product Name	Size of Open/Hole to install thru/in	Application
V8223140	AC-9452-DTA	Drop-Thru Anchor 4" Plate, 8' Cable	1-3/4" to 2" min. hole size (4.1cm to 4.4cm)	Temporary
V8223142	AC-9452-DTA-2	Drop-Thru Anchor 6" Plate, 8' Cable	1-3/4" to 2" min. hole size (4.1cm to 4.4cm)	Temporary
V8223144	AC-9452-DTA-4	Drop-Thru Anchor 6" Plate, 2' Cable	1-3/4" to 2" min. hole size (4.1cm to 4.4cm)	Temporary
V8223145	AC-9452-DTA-5	Drop-Thru Anchor 12" Plate, 8' Cable	1-3/4" to 2" min. hole size (4.1cm to 4.4cm)	Temporary
V8223146	AC-9452-DTA-6	Drop-Thru Anchor 12" Plate, 4' Cable	1-3/4" to 2" min. hole size (4.1cm to 4.4cm)	Temporary
V8223147	AC-9452-DTA-7	Drop-Thru Anchor 6" Plate, 4' Cable	1-3/4" to 2" min. hole size (4.1cm to 4.4cm)	Temporary
V8223148	AC-9452-DTA-8	Drop-Thru Anchor 4" Plate, 4' Cable	1-3/4" to 2" min. hole size (4.1cm to 4.4cm)	Temporary
V8222120	CP-12010-1	3/4" (19mm) Concrete Hole Anchor	3/4" (19mm)	Temporary
V8221121	CP-12010-2	3/4" (19mm) Toggle-Lok Anchor	3/4" (19mm)	Temporary



V8223140
AC-9452-DTA



V8222120
CP-12010-1



V8221121
CP-12010-2



NEW!



V820910X
RAS4

NEW!



V820950X
CAS4



V8205705 AC-6601 V8205704 AC-6600-48 V8205505 AC-6604



V820800X
AS-21000-X



V820860X
AS-21110-X

ANCHORAGE CONNECTORS

Anchor Slings

- Anchor slings provide peace of mind when a temporary anchor is required
- PeakWorks offers anchor slings using two basic material styles: abrasion-resistant webbing or galvanized cable
- All PeakWorks anchor slings are built to a minimum tensile strength of 5,000 lbs (22 kN)
- All PeakWorks anchor slings meet or exceed CSA and ANSI standards
- Peakworks introduces new line of anchor slings with added wear sleeve for durability



PRODUCT NO.	MODEL NO.	Product Name	Length	End Configuration	
V820910X	RAS4	Residential Anchor Sling	3', 4', 6' (0.9m, 1.2m, 1.8m)	Reinforced Loop	Loop
V820950X	CAS4	Commercial Anchor Sling	3', 4', 6' (0.9m, 1.2m, 1.8m)	Loop	D-Ring
V8205705	AC-6601	Choker Sling, 2 D-Rings, 60" L	5' (1.5m)	1 Large D-Ring	1 Small D-Ring
V8205704	AC-6600-48	Wrap Sling 48" L, 2 D-Rings	4' (1.2m)	1 Large D-Ring	1 Large D-Ring
V82005805	AC-6600	Wrap Sling 60" L	5' (1.5m)	Loop	1 Large D-Ring
V8205505	AC-6604	Choker Sling, 1 D-Ring, 1 Loop 60" L	5' (1.5m)	Loop	1 Large D-Ring
V820800X	AS-21000-X	Cable Anchor Sling, 1/4" (6mm) PVC Coated Galv. Cable	3', 4', 6' (0.9m, 1.2m, 1.8m)	Eye	Eye
V820860X	AS-21110-X	Cable Anchor Sling, 1/4" (6mm) PVC Coated Galv. Cable	2', 3', 4', 5', 6' (0.6m, 0.9m, 1.2m, 1.5m, 1.8m)	O-Ring	O-Ring

TANK TROLLEY™

The PeakWorks Fall Protection Tank Trolley™ is designed for use on water and fuel storage tanks. The Tank Trolley™ provides a 5,000 lbs. anchorage as required by OSHA and ANSI standards. The Tank Trolley simply rides on the top lip of the storage tank and can be used with a standard lanyard or self-retracting lifeline.

- Standards Compliance: Materials meet **OSHA 1926.5 subpart M, 1910.66 app. C, and ANSI A10.14**
- Trolley: Rollers 1/4" steel, powder coated finish with forged steel O-ring attachment, polyurethane composite material
- Capacity: Application 310 lb. designed working load
- **TROLLEY6:** Storage tanks with minimum 10' diameter, fits 1/4" to 1" flange widths
- **TROLLEY6A:** Storage tanks with minimum 10' diameter, fits 1" to 1-7/8" flange widths
- Made in USA



V82235
9900-TROLLEY6



V82236
9900-TROLLEY6A



9900-TROLLEY6

PRODUCT NO.	MODEL NO.	Description	Flange width	Weight
V82235	9900-TROLLEY6	Standard Tank Trolley™	Fits 1/4" to 1" Flange Widths	14 lbs. (6.4kg)
V82236	9900-TROLLEY6A	Wide Flange Tank Trolley™	Fits 1" to 1-7/8" Flange Widths	14.5 lbs. (6.6kg)



KITS





All you need in one convenient pail!



Pail-16L

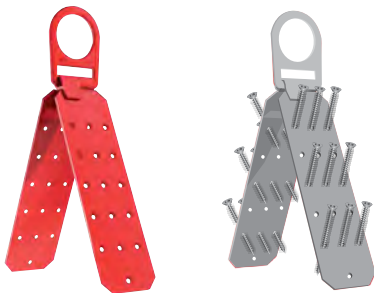

ROOFER'S KITS

RK6 Series Reusable Roofer's Kits

*
GOOD

Meet the new OSHA Residential Construction Regulation.

- PeakWorks' Roofer's Kit Fall Protection System includes an adjustable full body harness, a rope grab with integral shock absorber, reusable roof anchor bracket, and a waterproof bucket
- The three-point adjustable full body harness features quick-connect pass-thru buckles and polyester webbing for lightweight comfort and dependability
- The vertical lifeline is specifically designed from high-strength polysteel rope
- The manual rope grab includes an integral 3' shock-absorbing lanyard with a double-locking snap hook
- The reusable roof anchor bracket includes an attachment D-ring

All system components meet or exceed applicable **ANSI** and **OSHA** standards.

MODEL	V8257272 RK6-25 Contains:	V8257275 RK6-50 Contains:
Harness FBH-10002A	<ul style="list-style-type: none"> • Polyester webbing • Pass-thru buckles • Class A harness • Universal size • Three-point adjustable 	<ul style="list-style-type: none"> • Polyester webbing • Pass-thru buckles • Class A harness • Universal size • Three-point adjustable
Manual Rope Grab RG-12142	<ul style="list-style-type: none"> • Manual rope grab • Integral 3 ft. shock 	<ul style="list-style-type: none"> • Manual rope grab • Integral 3 ft. shock
Vertical Lifeline	<ul style="list-style-type: none"> • 5/8" (16mm) co-polymer rope • 25' (7.6m) long • 6,000 lbs. (27kN) minimum breaking strength 	<ul style="list-style-type: none"> • 5/8" (16mm) co-polymer rope • 50' (15m) long • 6,000 lbs. (27kN) minimum breaking strength
Snap Hooks	<ul style="list-style-type: none"> • 3/4" gate opening, steel • Double locking 	<ul style="list-style-type: none"> • 3/4" gate opening, steel • Double locking
Roof Bracket RB-9800	<ul style="list-style-type: none"> • Reusable bracket • 5,000 lb. breaking strength 	<ul style="list-style-type: none"> • Reusable bracket • 5,000 lb. breaking strength
Max Working Load	<ul style="list-style-type: none"> • 310 lbs. (141kg) • Single person use only 	<ul style="list-style-type: none"> • 310 lbs. (141kg) • Single person use only

DID YOU KNOW?

PeakWorks offers two different styles of roofing kits to meet your needs. The **RK6** kit incorporates a three-point compliance harness with quick-connect mating buckles, and the **RK7** kit incorporates a three-point compliance harness with tongue buckles. Both kits include a vertical lifeline with integral manual rope grab. The rope grab includes a shock-absorbing lanyard to reduce arresting forces. The roof anchor requires 3" x #10 screws (not included) to install the anchor to the structure.

ROOFER'S KITS

RK7 Series Reusable Roofer's Kits



Meet the new OSHA Residential Construction Regulation.

- PeakWorks' Roofer's Kit Fall Protection System includes an adjustable full body harness with grommeted leg straps, a rope grab with integral shock absorber, reusable roof anchor bracket, and a waterproof bucket
- The three-point adjustable full body harness features grommeted leg strap buckles and polyester webbing for lightweight comfort and dependability
- The vertical lifeline is specifically designed from high-strength polysteel rope
- The manual rope grab includes an integral 3' shock-absorbing lanyard with a double-locking snap hook
- The reusable roof anchor bracket includes an attachment D-ring

All system components meet or exceed applicable **ANSI** and **OSHA** standards.

MODEL	V8257282 RK7-25 Contains:	V8257285 RK7-50 Contains:
Harness FBH-10022A	<ul style="list-style-type: none"> • Polyester webbing • Grommeted leg straps • Class A harness • Universal size • Three-point adjustable 	<ul style="list-style-type: none"> • Polyester webbing • Grommeted leg straps • Class A harness • Universal size • Three-point adjustable
Manual Rope Grab RG-12142	<ul style="list-style-type: none"> • Manual rope grab • Integral 3 ft. shock 	<ul style="list-style-type: none"> • Manual rope grab • Integral 3 ft. shock
Vertical Lifeline	<ul style="list-style-type: none"> • 5/8" (16mm) co-polymer rope • 25' (7.6m) long • 6,000 lbs. (27kN) minimum breaking strength 	<ul style="list-style-type: none"> • 5/8" (16mm) co-polymer rope • 50' (15m) long • 6,000 lbs. (27kN) minimum breaking strength
Snap Hooks	<ul style="list-style-type: none"> • 3/4" gate opening, steel • Double locking 	<ul style="list-style-type: none"> • 3/4" gate opening, steel • Double locking
Roof Bracket RB-9800	<ul style="list-style-type: none"> • Reusable bracket • 5,000 lb. breaking strength 	<ul style="list-style-type: none"> • Reusable bracket • 5,000 lb. breaking strength
Max Working Load	<ul style="list-style-type: none"> • 310 lbs. (141kg) • Single person use only 	<ul style="list-style-type: none"> • 310 lbs. (141kg) • Single person use only

REPLACEMENT PARTS		
PRODUCT NO.	MODEL NO.	Product Name
V8001000	FBH-10002A	
V8001200	FBH-10022A	
V84088025		25' Vertical Lifeline with Rope Grab
V84088050		50' Vertical Lifeline with Rope Grab
V8229100		RB-9800 Reusable Bracket



All you need in one convenient pail!



Pail-16L

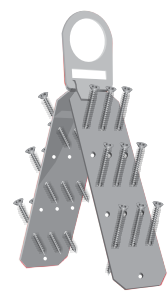



V8252366 Front
Model 4400-BA1CKTS



V8252366 Back
Model 4400-BA1CKTS

COMPLIANCE KIT



The PeakWorks® Compliance Kit includes an all-in-one harness and shock-absorbing lanyard. The full-body harness features three points of adjustment for ultra-lightweight comfort. Quick-connect pass-thru buckles, located on the chest and legs, make it easy for donning. All of the PeakWorks harnesses include fall indicators for ease of inspection and two lanyard parks for easy and safe storage. The shock-absorbing lanyard is certified to the newest ANSI standards. The shock-absorbing lanyard is permanently attached to the rear dorsal D-ring for simplicity. The lanyard is comprised of “tear webbing”, which will significantly limit and reduce the force of a fall on a worker.

V8252366

Model 4400-BA1CKTS

Description	Compliance Harness	Permanently Affixed Shock Pack Lanyard
Style	<ul style="list-style-type: none"> Class A harness Three-point adjustable pass-thru buckles 	<ul style="list-style-type: none"> Single leg, tear pack One double-locking snap hook — permanently attached
Materials	<ul style="list-style-type: none"> Polyester webbing Steel buckles 	<ul style="list-style-type: none"> 1" polyester webbing 3/4" gate opening, steel snap hook
Standards	<ul style="list-style-type: none"> OSHA Certified to ANSI Z359.11 Certified to CSA Z259.10 	<ul style="list-style-type: none"> OSHA Certified to ANSI Z359.13
Size	<ul style="list-style-type: none"> Universal 	<ul style="list-style-type: none"> 6' (1.8m) length
Operating Temperature	<ul style="list-style-type: none"> -31°F to 95°F (-35°C to 35°C) 	<ul style="list-style-type: none"> -31°F to 95°F (-35°C to 35°C)
Max Working Load	<ul style="list-style-type: none"> 130 to 310 lbs. (60 to 141kg) Single person use only 	<ul style="list-style-type: none"> 130 to 310 lbs. (60 to 141kg) Single person use only

DID YOU KNOW?

All PeakWorks full body harnesses incorporate the Safe-T-Fold stress indicator in back of the harnesses. If the fold has been deployed, do not use and replace the harness immediately.



The PeakWorks® Contractor Kit includes a harness and shock-absorbing lanyard. The full-body harness features five points of adjustment for maximum comfort (two shoulder, two leg, one chest). Quick-connect pass-thru buckles, located on the chest and legs, make it easy for donning. All of the PeakWorks harnesses include fall indicators for ease of inspection and two lanyard parks for easy and safe storage. The shock-pack lanyard is certified to the newest ANSI standards. The shock-absorbing lanyard is comprised of "tear webbing", which will significantly limit and reduce the force of a fall on a worker.

V8252356

Model 4456-KIT03S

Description	Contractor Harness	Shock Pack Lanyard
Style	<ul style="list-style-type: none"> Class A harness Five-point adjustable pass-thru buckles 	<ul style="list-style-type: none"> Single leg, tear pack 3/4" gate opening steel, double-locking snap hooks
Materials	<ul style="list-style-type: none"> Polyester webbing Steel buckles 	<ul style="list-style-type: none"> 1" polyester webbing Steel snap hook
Standards	<ul style="list-style-type: none"> OSHA Certified to ANSI Z359.11 Certified to CSA Z259.10 	<ul style="list-style-type: none"> OSHA Certified to ANSI Z359.13
Size	<ul style="list-style-type: none"> Universal 	<ul style="list-style-type: none"> 6' (1.8m) length
Operating Temperature	<ul style="list-style-type: none"> -31°F to 95°F (-35°C to 35°C) 	<ul style="list-style-type: none"> -31°F to 95°F (-35°C to 35°C)
Max Working Load	<ul style="list-style-type: none"> 130 to 310 lbs. (60 to 141kg) Single person use only 	<ul style="list-style-type: none"> 130 to 310 lbs. (60 to 141kg) Single person use only

DID YOU KNOW?
 All PeakWorks full body harnesses feature the letter "A" and an arrow pointing to the rear dorsal D-ring. This indicates the connector should always be connected to the rear dorsal D-ring for fall arrest.



V8252356 Front
 Model 4456-KIT03S



V8252356 Front
 Model 4456-KIT03S



V8252406
FK-010



V8252416
FK-011



V8252306
FK-005

CONTRACTOR KITS



V8252406

- Harness: FBH-10002A Compliance Harness, Class A with pass-thru buckles legs and chest
- Connector: SRL-65105-6LE Self-Retracting Device LE, 6' length with snap hook
- Bag: BAG-001 Large Mesh Bag

PRODUCT NO.	MODEL NO.	Product Name	Weight Capacity
V8252406	FK-010	Compliance Kit: FBH-10002A + SRL-65105-6LE+ BAG-001	130 to 310 lbs. (60 to 141kg)

V8252416

- Harness: FBH-10000A Contractor Harness, Class A with pass-thru buckles legs and chest
- Connector: SRL-65105-6LE, Self-Retracting Device LE, 6' length with snap hook
- Bag: BAG-001 Large Mesh Bag

PRODUCT NO.	MODEL NO.	Product Name	Weight Capacity
V8252416	FK-011	Contractor Kit: FBH-10000A + SRL-65105-6LE+ BAG-001	130 to 310 lbs. (60 to 141kg)

V8252306

- Harness: FBH-10020A Contractors 1D with Tongue & Grommet Legs
- Connector: SA-7400-6U Shock Pack 6' with Regular Snap Hooks
- Bag: BAG-001 Large Mesh Bag

PRODUCT NO.	MODEL NO.	Product Name	Weight Capacity
V8252306	FK-005	Contractor Kit: FBH-10020A + SA-7400-6U+ BAG-001	130 to 310 lbs. (60 to 141kg)

CONTRACTOR KITS



V8252316

- Harness: FBH-10020A Contractors 1D with Tongue & Grommet Legs
- Connector: SA-7402-6U Shock Pack 6' with One Regular Snap Hook + One Form Hook
- Bag: BAG-001 Large Mesh Bag

PRODUCT NO.	MODEL NO.	Product Name	Weight Capacity
V8252316	FK-006	Contractor Kit: FBH-10020A + SA-7402-6U + BAG-001	130 to 310 lbs. (60 to 141kg)

V8252326

- Harness: FBH-10020A Contractors 1D with Tongue & Grommet Legs
- Connector: SA-84000-6U 100% Tie-Off Shock Pack 6' with Three Regular Snap Hooks
- Bag: BAG-001 Large Mesh Bag

PRODUCT NO.	MODEL NO.	Product Name	Weight Capacity
V8252326	FK-007	Contractor Kit: FBH-10020A + SA-84000-6U + BAG-001	130 to 310 lbs. (60 to 141kg)

V8252336

- Harness: FBH-10020A Contractors 1D with Tongue & Grommet Legs
- Connector: SA-84022-6U 100% Tie-Off Shock Pack 6' with One Regular Snap Hook + Two Form Hooks
- Bag: BAG-001 Large Mesh Bag

PRODUCT NO.	MODEL NO.	Product Name	Weight Capacity
V8252336	FK-008	Contractor Kit: FBH-10020A + SA-84022-6U + BAG-001	130 to 310 lbs. (60 to 141kg)

V8252346

- Harness: FBH-10020B Contractors 3D (One Fall Arrest + Two Side D-Rings) with Tongue and Grommet Legs
- Connector: SA-84000-6U 100% Tie-Off Shock Pack 6' with Three Regular Snap Hooks
- Bag: BAG-001 Large Mesh Bag

PRODUCT NO.	MODEL NO.	Product Name	Weight Capacity
V8252346	FK-009	Contractor Kit: FBH-10020B + SA-84000-6U + BAG-001	130 to 310 lbs. (60 to 141kg)



V8252316
FK-006



V8252326
FK-007



V8252336
FK-008



V8252346
FK-009

CONFINED SPACE KITS



V845534060
SRL-53303-60

Three-way SRL-R rescue available with multiple lifeline lengths



V85011
TR-100

A PEAKWORKS EXCLUSIVE!
Offset pulley above head ensures cable is centered over tripod



V8460
SRL-53303-BRKT

Three-way bracket comes pre-installed on each tripod



V845179065
MW-65G

Easy-to-assemble man winch includes 65' of galvanized cable with a lifting capacity of 900 lbs.

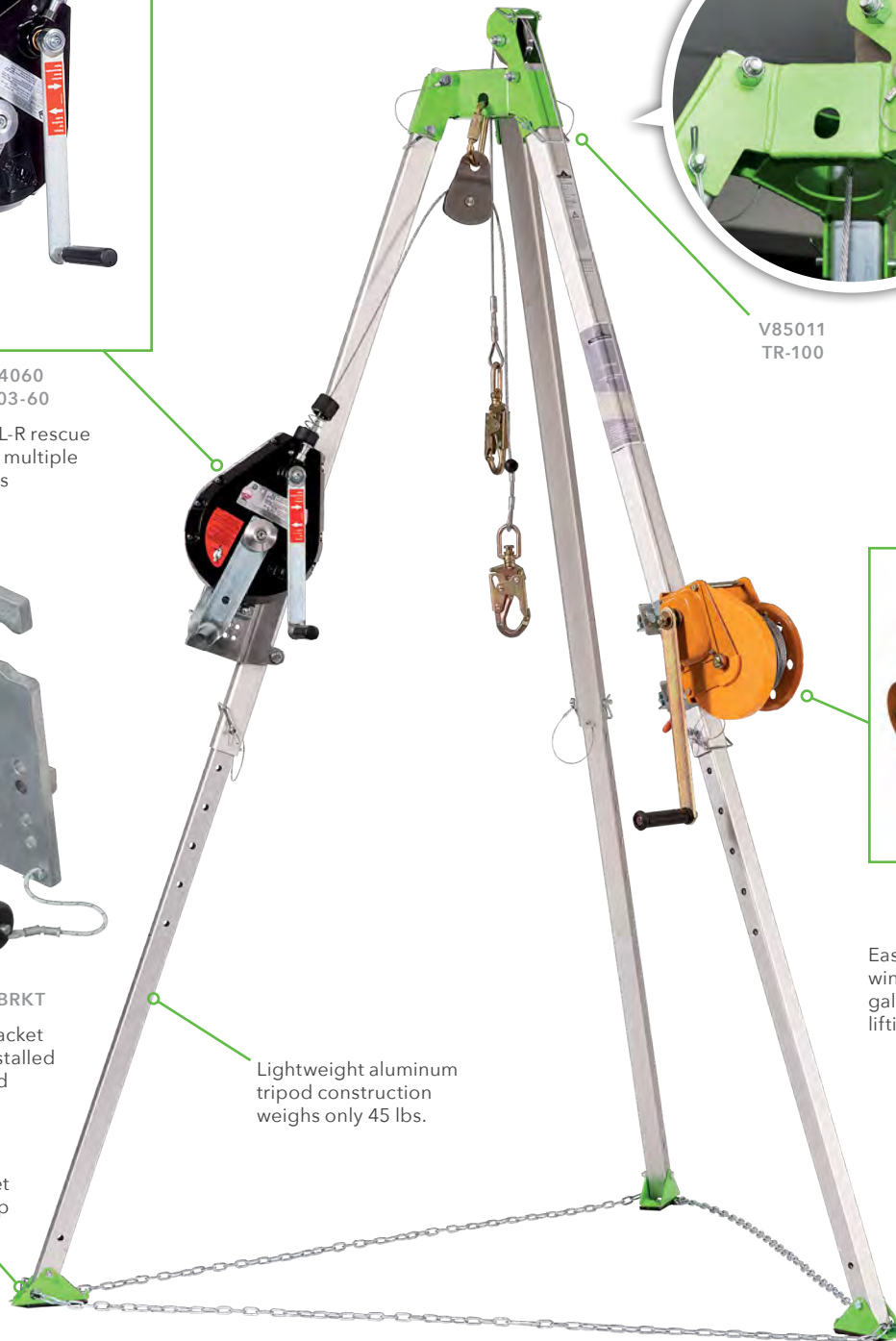

V85026
CSK3-60

Lightweight aluminum tripod construction weighs only 45 lbs.

Swivel steel feet include non-slip rubber base

PEAKWORKS CONFINED SPACE KITS —
LIGHTWEIGHT • DURABLE • SAFETY

CONFINED SPACE KITS – COMPLETE KITS



- The PeakWorks engineering team has developed a unique tripod with distinct advantages over the competition
- The PeakWorks TR-100 Tripod offers a built-in pulley system that is located above the head assembly
- The placement of this pulley situates the wire rope cable directly over the center point of the tripod for superior perfect operator balance
- Locating the pulley system above the head assembly also allows the operator increased head room over traditional “below-the-head” pulley systems
- The PeakWorks TR-100 features adjustable aluminum legs complete with swivel steel feet and non-slip rubber bases
- The TR-100 can be used with a 65' (20m) Man-Rated Winch (MW-65G) or, by attaching the tripod mounting bracket, with a PeakWorks SRL-53303 60' (18m) or 108' (33m) recovery style SRL
- 7' (2.1m) tripod features adjustable locking legs, two additional anchorage points, non-slip safety feet and safety chain
- MW-65G man winch features 65' (20m) galvanized cable with swivel hook, 300 lb. (135kg) capacity
- 310 lb. (141kg) capacity (combined weight of person, tools, clothing, etc.)
- Meets or exceeds **CSA Z259.15** and **ANSI Z359.18** and **OSHA** requirements



V85024
CSK1-60



V85025
CSK2-65

PRODUCT NO.	MODEL NO.	Product Name
V85024	CSK1-60	Confined Space Kit: Tripod, 3-Way 60' (18m) SRL and Bag
V85025	CSK2-65	Confined Space Kit: Tripod, 65' (20m) Man Winch and Bag
V85026	CSK3-60	Confined Space Kit: Tripod, 3-Way 60' (18m) SRL, 65' (20m) Man Winch and Bag, shown in page 292



V845179065
MW-65G



V85011
TR-100



V860005
BAG-005



V855130
CP-15300-3



V8460
SRL-53303-BRKT



V860153
CP-41210-3

CONFINED SPACE KITS – REPLACEMENT COMPONENTS

Confined Space Tripod Systems are commonly used for fall arrest, rescue/retrieval, and material handling. Common applications for the PeakWorks confined space system include difficult to access areas such as manholes, sewer systems, tanks, pits, crawl spaces and silos.

Quick note: When using a confined space system, do not use the 3-way SRL as a primary means to lower or retrieve personnel or material. A man winch should be used instead and the 3-way SRL should be used as a secondary fall arrest system.

PeakWorks recommends the use of a confined space yoke in combination with a Class AE full-body harness when lifting or lowering personnel in to a confined space.

PeakPro Plus Series



V800517X
Page 247

Contractor Series



V8002030
Page 255

PRODUCT NO.	MODEL NO.	Product Name
V845179065	MW-65G	65' (20m) Man Winch with 3/16" (5mm) Cable and Swivel Hook
V85011	TR-100	7' (2.1m) Tripod with Chain and Pulley
V860005	BAG-005	Tripod Carrying Bag (see page 303)
V855130	CP-15300-3	Confined Space Yoke
V8460	SRL-53303-BRKT	Tripod Mounting Bracket for SRL-53303
V860153	CP-41210-3	Stainless Steel Pulley – Single Oscillating Side Plates (see page 297)

RESCUE PRODUCT KITS



- OSHA requires that all employers meet the requirement for prompt rescue including personal escape, self rescue, and assisted rescue before employees work at heights.
- As time is critical when responding to a worker in need, it is incumbent upon all job sites to have the right equipment and proper training available in case of an emergency.
- PeakWorks offers a wide range of equipment and training to help you develop the rescue system required for your specific application.
- Contact your representative for details.



Res-Q-Pole

- The PeakWorks Res-Q-Pole with Res-Q-Head is an innovative and effective solution designed to remotely connect a carabiner to a fallen worker or anchor.
- The pole is a strong yet lightweight fiberglass-constructed telescoping pole that reaches from 6' to 12' (1.8 to 3.7m).
- A lightweight bracket holds the carabiner open until the operator hooks onto the victim's D-ring or anchor and pulls back. At that point, the carabiner is released from the head and snaps shut.
- Designed for use with the CP-03015-1 carabiner (sold separately).

Res-Q-Kit

- The Res-Q-Kit is a unique 4:1 100' (30.4m) raise and lower kit; it allows a person to be lowered using friction or raised by using a mechanical one-directional pulley.
- The Res-Q-Kit is our most effective retrieval kit.



V855121
RES-Q-POLE w RES-Q-HEAD



V85523100
RES-Q-KIT 100'



V860120
CP-03015-1

PRODUCT NO.	MODEL NO.	Product Name
V855121	RES-Q-POLE w/ RES-Q-HEAD	Rescue Pole, Telescoping 6' to 12' (1.8m to 3.7m), with Rescue Head Carabiner Attachment
V85523100	RES-Q-KIT 100'	Res-Q-Kit, 100' (30.4m)

About Confined Space

A confined space is an area, other than an underground working, that:

- is enclosed or partially enclosed;
- is not designed or intended for continuous human occupancy;
- has limited or restricted means for entry or exit that may complicate the provision of first aid, evacuation, rescue or other emergency response or service;
- is large enough and so configured that a worker could enter to perform assigned work

Confined space has limited openings for entry and exit. Examples would be spaces such as: silos, vats, ship holds, sewers, tunnels, large pipelines and other such spaces that humans could enter to perform work.



CONFINED SPACE AND RESCUE KITS

Davit Systems

Davit systems are a permanent or temporary solution for confined space where a traditional tripod does not meet your needs. PeakWorks' davit system offers numerous configurations to suit an application.

Davit system includes:

- Davit V845534060, 3-way SRL-R rescue, and V845179065 man/material winch.
- Lightweight and portable
- High strength construction
- Easy, fast set up
- Man-rated for work positioning, confined space entry/retrieval, rescue, fall protection and material handling
- Rated for working load limit of one person (310 lbs capacity including clothing, tools and equipment)
- Legs can be adjusted to extend up to 6', 75" entry point
- Reach 28"
- Height 84"
- Weight 89 lbs. (includes weight of 3-way SRL and winch)

Standards compliance:

- Work Positioning: **OSHA 29 CFR 1926, subpart L**
- Rescue: **ANSI Z359.4**
- Confined Space: **OSHA 1910.146, ANSI Z117.1**

NEW!

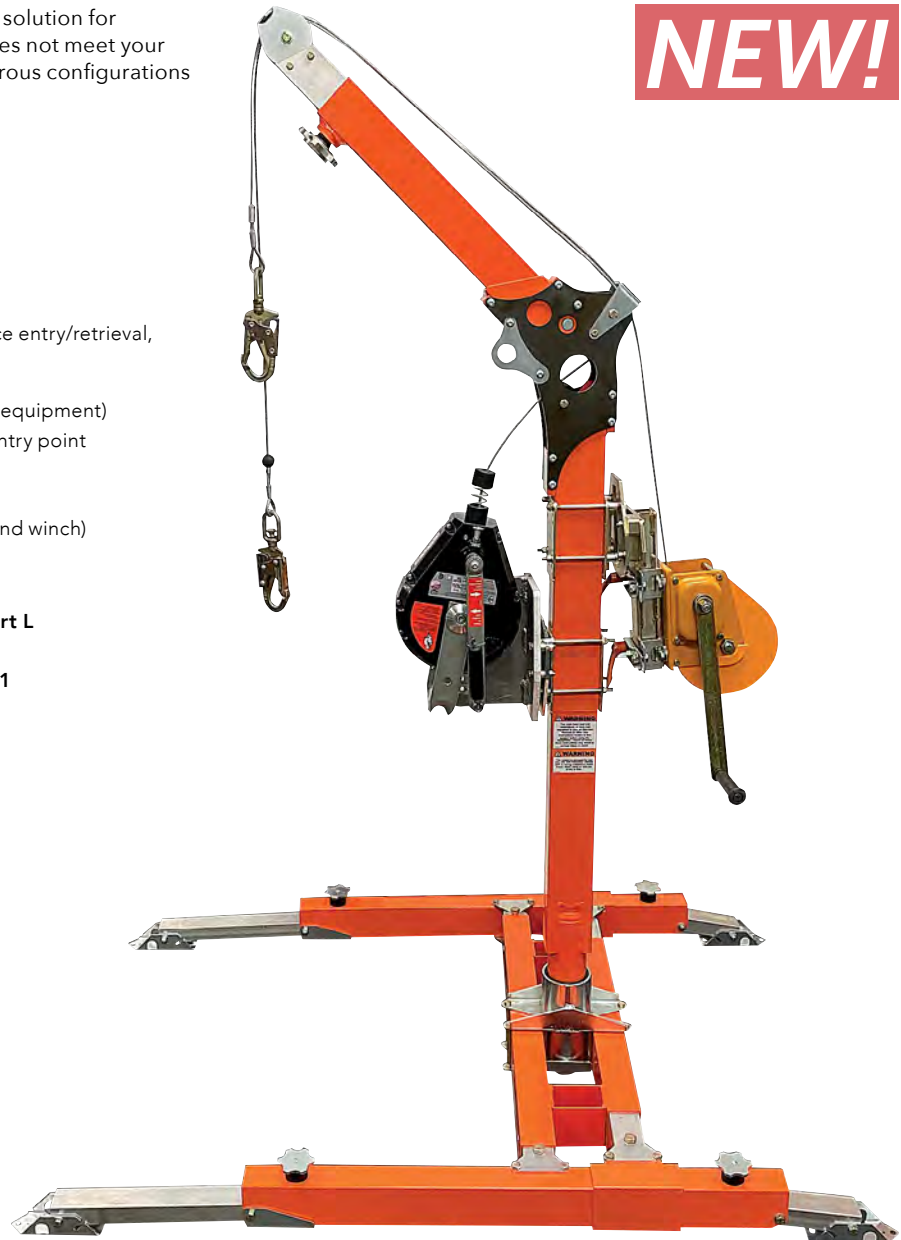

V85043
Davit Arm System

PRODUCT NO.	MODEL NO.	Product Name
V85043	DSK3-60	Complete Davit System with 3-Way SRL, 60' length, Man/Material Winch, 65' length

Give us a call to help you design your confined space system

HARDWARE AND ACCESSORIES



V860001
BAG-001



V860004
BAG-004



V860005
BAG-005



V860006
BAG-006



V860402
RFID-1



V860901
MERCH-TORSO



V860120
CP-03015-1



V860121
CP-03015-2



V860130
CP-04011-1



V860153
CP-41210-3



V860904
ABC-DISPLAY

- Educate your customers on the ABCs of Fall Protection:
 - Anchorage
 - Body Support
 - Connecting Means
- Eye catching innovative display maximizes sales and profit
- Fully customizable to meet the needs of your industry
- Designed for use on floor, peg board, or slat wall
- Includes 25 "Know Your ABCs Fall Protection Guide"
- Hardware included and easy to set up
- Total dimensions are 60" length x 47" width

PRODUCT NO.	MODEL NO.	Product Name
V860001	BAG-001	Large Mesh Harness Bag 15" x 12" (38cm x 31cm)
V860004	BAG-004	PeakWorks Carrying Bag 10" x 12" x 12" (25cm x 31cm x 31cm)
V860005	BAG-005	Tripod Carrying Bag for TR-100 10" x 58" x 10" (147cm x 25cm x 25cm)
V860006	BAG-006	Premium Tripod Carrying Bag for TR-100 15" x 60" (38cm x 152cm)
V860402	RFID-1	RFID Pouch with Grommet
V860901	MERCH-TORSO	Merchandising Torso for Harness

PRODUCT NO.	MODEL NO.	Product Name
V860120	CP-03015-1	Carabiner 1" (25mm) CSA CE
V860121	CP-03015-2	Carabiner 3/4" (19mm) CSA for CG-9001 & SRL-10301-8
V860130	CP-04011-1	Carabiner 2" (50mm) CSA for Scaffolding
V860153	CP-41210-3	Tripod Pulley
V860904	ABC-DISPLAY	ABC Display designed for use on floor, peg board or slot wall, fully customizable

A worker wearing an orange hard hat, safety glasses, a grey t-shirt, and dark jeans is climbing a metal cable ladder system. He is wearing a bright green safety harness with multiple attachment points. The ladder is mounted against a white brick wall. The background shows a warehouse interior with stacks of boxes and a concrete floor.

PEAKWORKS™

LADDER SAFETY SYSTEM

**CABLE
LADDER
SYSTEM
SHOWN**

LADDER SAFETY SYSTEM

What's Changed for Fixed Ladders Under OSHA 1910 Walking-Working Surface Standard?



Fixed ladders provide stability when ascending to an elevated work surface because they are fastened to a building or a secure surface. In the past, OSHA has required cages for ladders taller than 20 feet, but as of November 19, 2018, fall protection is required on ladders taller than or that extend beyond 24 feet. Several of the important changes are listed below.

- **New height requirement.** Fall protection is required on ladders taller than or that extend beyond 24 feet.
- **New equipment specification.** As of November 19, 2018, cages are no longer considered compliant fall protection in newly-installed ladders. To meet OSHA standards, a personal fall arrest system or a ladder safety system is required.
- **Repair/replacement specifications.** As of November 19, 2018, a personal fall arrest ladder system or ladder safety system will be used to replace any damaged or nonfunctioning section, cage, or well that was previously installed on a fixed ladder.
- **Need more information?** For a more detailed explanation of OSHA 1910, visit www.osha.gov/walking-working-surfaces.

PeakWorks® offers two different ladder safety systems that meet or exceed the new regulations:

- **Fixed Rail System**
- **Cable System**

A low-angle photograph of a worker on a fixed ladder. The ladder is a white metal structure with a safety cage, mounted on a large, curved, metallic cylindrical structure. The worker is wearing a hard hat and safety gear. The background is a clear blue sky.

**RAIL OR CABLE
SOLUTIONS AVAILABLE
FOR OUTDATED
LADDER CAGES**



LADDER SAFETY SYSTEM – CABLE

PeakWorks® vertical cable ladder systems are designed for hands-free movement and 100% protection. The system consists of a top and bottom bracket, and a cable that is attached to these brackets at both ends. The cable grab connects the worker to the system and provides a hands-free climb without ever having to manipulate the cable grab. For longer systems, PeakWorks® provides intermediate brackets to minimize the vibration of the system.

Systems come in standard lengths of 30', 50', 100', and 200' which are in stock and can be customized for exact requirements.

Features:

- Fewer parts allow for simple installation and inspection
- Pre-swaged cable termination; 7x19 high-strength galvanized 3/8" steel cable provides simple and easy installation and low maintenance
- System designed for ladder rung installation only; contact SureWex for climb extension and removable extension options coming soon
- Designed working load is 310 lbs.
- Standards Compliance: **ANSI A10.14, OSHA 1910.66, 1926.500**

ORDERING NO.	Cable Length	Guides Included
V865420	30' Cable Ladder Safety System	0
V865423	50' Cable Ladder Safety System	1
V865428	100' Cable Ladder Safety System	3
V865438	200' Cable Ladder Safety System	6

Above kits include all hardware below:

Upper and lower brackets; specified aircraft cable length; 7x19 galvanized aircraft cable, 3/8"; cable guide for every 25' spacing; and Peakworks CableGrab™ Safety Sleeve

Don't forget your PeakWorks harness!

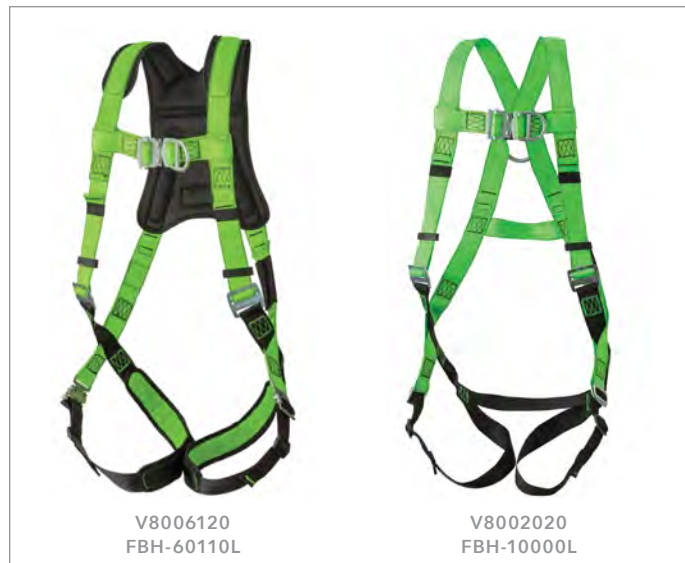

See pages 242–256 for our complete offering

LADDER SAFETY SYSTEM – CABLE

CableGrab™

The CableGrab™ is a detachable sliding device which moves freely up or down hands free on the 3/8" galvanized steel cable. When the upward force is removed, the CableGrab device automatically locks at any point on the cable. The instantaneous locking is achieved through an effective cam-locking system. The system includes a double-locking carabiner which is to be used when securing the CableGrab™ device to the climber's full body harness.

- The CableGrab™ glides freely up or down the cable as the worker climbs
- Dual independent cams designed to immediately lock on to the cable and arrest the fall. The CableGrab™ will remain locked until the worker can step back onto the ladder or be rescued
- Easy to install and detach anywhere along the cable
- Intended for use on 3/8" diameter solid core cable system
- Intended for use with a 2" self-locking carabiner and attached to a front D-ring full-body harness
- Maximum length of the connector to the wire grab from the harness should not exceed 9'
- 2.75 lbs lightweight construction

PRODUCT NO.	Designed Working Load	Dimensions
V865192	310 lbs.	5" x 8" x 2.5"



CableGrab™

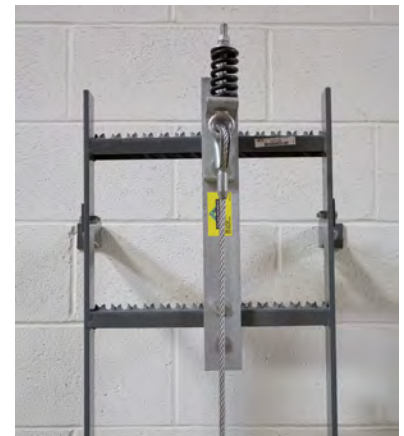

Top



Bottom



Cable Guide



LADDER SAFETY SYSTEM – RAIL

2000 Series Climb-Rite® Fixed Rail Ladder Safety System

The Climb-Rite® fixed rigid rail ladder system offers workers 100% fall protection when climbing permanent ladders. Each are custom designed by our in-house engineering staff to provide the right solution for your needs. The system works by bringing four hardened steel brakes into contact with the rail as soon as a fall is detected. Using a detachable sliding sleeve that rolls freely up and down the rail, the Climb-Rite® system can be used both above and below ground, and on interior or exterior surfaces.

100% Fall Protection for Fixed Ladders

The complete climbing system includes the Climb-Rite® device, 10' rail sections, rail splices, rail stops, parking pins, and rung clamps. The system has been designed without rail notches or serrations that can corrode or rust. Rail extensions and unique SkySwivel™ rotation device are available for safe ladder access and egress.

Features:

- System glides effortlessly, allowing hands-free movement up and down the ladder
- Easy to install, remove, and maintain
- Climbing device weighs only 2 lbs.
- All ladder hardware is corrosion-resistant stainless steel
- Type 316 stainless steel rail is available for marine or other corrosive environments
- Can be mounted to side or center of ladder
- Ladder extensions available
- Accommodates multiple workers
- Easy to order complete kits and simple installation kits
- Meets OSHA and ANSI standards

PART NO. FOR STAINLESS STEEL	SYSTEM LENGTH	Section of 10 ft. Rails	Number of Ladder Rung Clamps Included
V865191	10'	1	3
V865193	20'	2	5
V865195	30'	3	8
V865196	40'	4	10
V865197	50'	5	12
V865198	60'	6	14
V865199	70'	7	16

Kits include 1" diameter round rung clamps. Contact SureWerx for additional shapes and sizes.

Give us a call to help you design your Climb-Rite® Fixed Rail Ladder System

LADDER SAFETY SYSTEM – RAIL

Climb-Rite® Trolley

- Detachable sliding safety device that attaches to a vertical fixed rail for fall arrest protection
- Weighs 3.25 lbs.
- Made of CNC-machined aluminum with stainless steel pins, Zytel™ roller bearings, stainless steel spring, and stainless steel bolts
- Fits a 1/2" x 2" stainless steel rail or T-shaped aluminum 1/4" x 2" rail
- Swivel snap hook is permanently attached to the D-ring on the Climb-Rite® device
- Complies to **OSHA 1910.27(d) & 1926.1053** for Ladder Safety Devices
- Complies to **ANSI A14.3 (1992)** Fixed Ladder Safety Standard

PART NO.	Designed Working Load	Dimensions
V865190	310 lbs.	4" x 3-1/2" x 3"

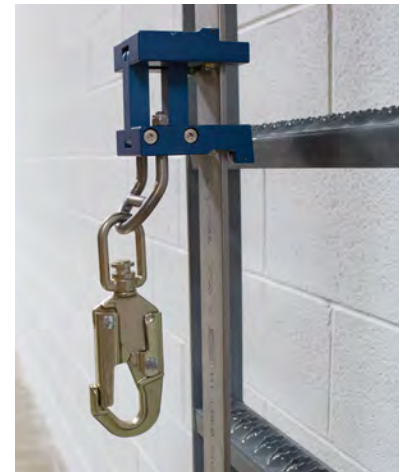

2000 Climb-Rite® Trolley



Stainless steel rail



V8651203



Removable Ladder Extension – Top

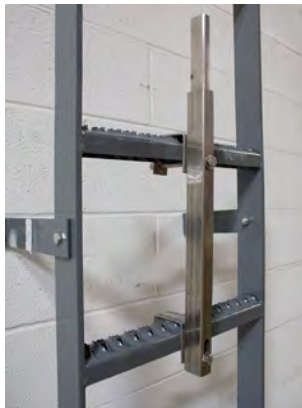

Bottom

LADDER SAFETY SYSTEM – RAIL

Rail

- Used for the Climb-Rite® ladder climbing system and the RailWalker® system
- Connects to ladder with rung clamps
- Connections are spaced every 6" space on stainless steel rails
- Join sections of rail using rail splice 9200-SSPL
- Complies to **OSHA 1910.27(d) & 1926.1053** for Ladder Safety Devices
- Complies to **ANSI A14.3 (1992)** Fixed Ladder Safety Standard

PART NO.	Dimensions	Material	Weight
V8651164	10' x 2" x 1/4"	316 Stainless Steel	18 lbs.
V8651162	10' x 2" x 1/4"	304 Stainless Steel	18 lbs.
V8651126	10' x 2"	T6 Aluminum	12 lbs.

Rail Splice Plate

- Rail splice plate for the Climb-Rite® ladder climbing system
- Weighs 1.56 lbs.
- Made of 304 series stainless steel
- Includes stainless steel hardware
- Complies to **OSHA 1910.27 & 1926.1053**
- Complies to **ANSI A10.14**

PART NO.	Material
V8651203	304 Stainless Steel

Permanent Ladder Extension

- Stainless fixed ladder extension for the Climb-Rite® Ladder climbing system
- Weighs approximately 10 lbs.
- Made of 316 series stainless steel or 304 series stainless steel
- Connects to ladder with two rung clamps
- Complies to **OSHA 1910.27 & 1926.1053** for Ladder Safety Devices
- Complies to **ANSI A14.3 (1992)** Fixed Ladder Safety Standard

PART NO.	Dimensions	Material
V8651153	66" long	304 Stainless Steel
V8651154	66" long	316 Stainless Steel

Removable Ladder Extension Kit

- Allows the Climb-Rite® System to extend above the ladder
- Includes top and bottom portion of removable ladder for the Climb-Rite® ladder climbing system
- Weighs approximately 20 lbs.
- Complies to **OSHA 1910.27 & 1926.1053** for Ladder Safety Devices
- Complies to **ANSI A14.3 (1992)** Fixed Ladder Safety Standard

PART NO.	Dimensions	Material
V8651161	2" wide x 66" long	316 Stainless Steel
V8651160	2" wide x 66" long	304 Stainless Steel

LADDER SAFETY SYSTEM – RAIL



Ladder Rung Clamp

- Attachment hardware to connect PeakWorks ladder safety systems to ladder rungs
- Weighs .4 to .68 lbs.
- Made of 316 series stainless steel
- Rung clamps also available for other shapes and sizes; contact SureWerx
- Complies to **OSHA 1910.27 & 1926.1053** for Ladder Safety Devices
- Complies to **ANSI A14.3 (1992)** Fixed Ladder Safety Standard

Round

PART NO.	Rung Clamp Size
V8651173	5/8" Round
V8651175	3/4" Round
V8651182	7/8" Round
V8651185	1" Round

Square

PART NO.	Rung Clamp Size
V8651176	3/4" Square
V8651187	1" Square
V8651189	1-1/4" Square

Diamond

PART NO.	Rung Clamp Size
V8651184	1" Diamond



Round



Square



Diamond

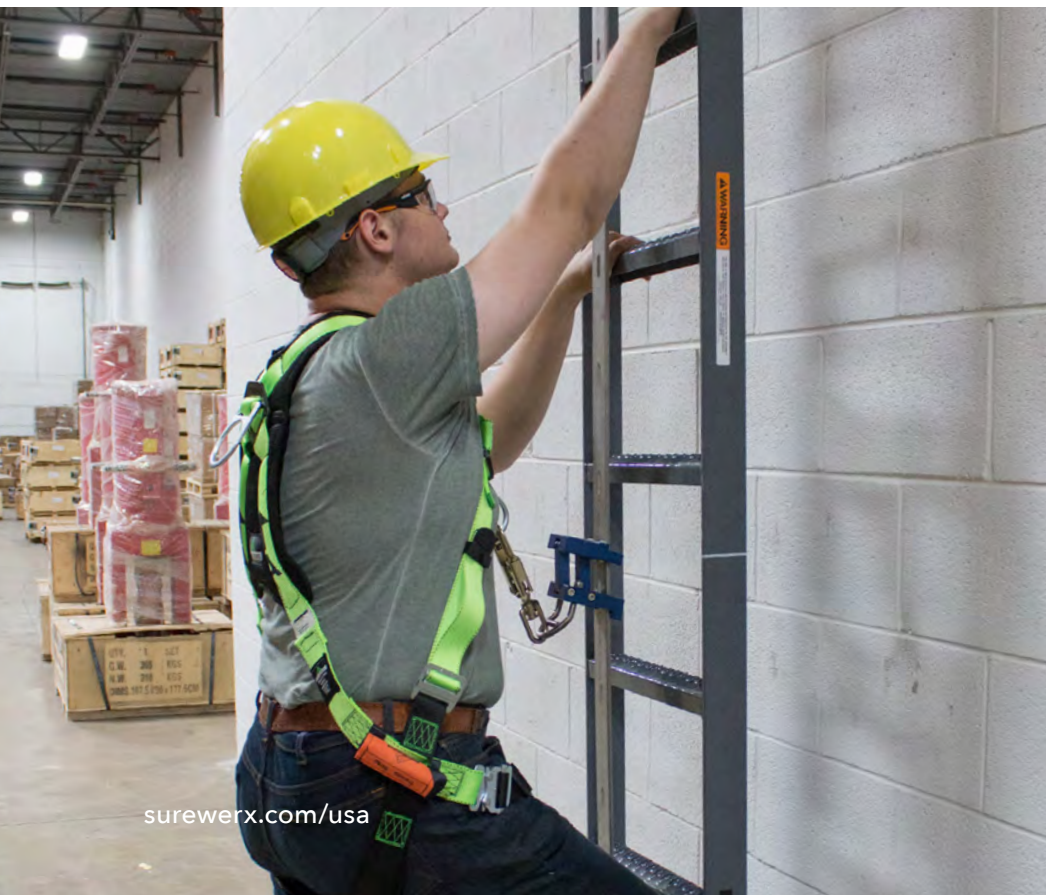



EMERGENCY DESCENT SYSTEMS

**ESCAPE-RITE®
SYSTEM SHOWN**

EMERGENCY DESCENT SYSTEMS

Escape-Rite® Series

PeakWorks' Escape-Rite® is an emergency controlled descent device that has been trusted in the field for decades. The Escape-Rite® device helps employers meet the OSHA requirement for prompt rescue including personal escape, self-rescue and assisted rescue. It is compact, lightweight, and very simple to use. Its bi-directional design provides the capability for more users to evacuate in a short period of time. As a descent is initiated, the other end of the rope ascends, making it ready for another rescue automatically. Available in two descent rate options of 3' or 6' per second, depending on the height and number of users needed to evacuate. Angled descent packages are available for approved applications ranging from 45 to 90 degrees.

- Unit Dimensions: 18" x 9.75" x 8"
- Maximum Working Load: 400 lbs. (181 kg) — one person descent at a time
- Weight: Unit w/ spool: 12.25 lbs. Cable: .06 lb./ft.
- Made in the USA

PRODUCT NO.	MODEL NO.	Description	System Lengths	User Weight Capacity
V85531-XX	1003-DEVXXX	Escape-Rite descent rate approx. 3'/s (0.91m/s)	10'-300' (3m to 91.4m)	400 lbs. (181kg), one person descent at a time
V85532-XX	1006-DEVXXX	Escape-Rite descent rate approx. 6'/s (1.83m/s)	10'-300' (3m to 91.4m)	400 lbs. (181kg), one person descent at a time

-XXX denotes the length of the system

Escape-Rite Applications

- Ski lift rescue
- Portable rescue
- High-rise buildings
- Overhead crane cabs
- Offshore oil rig platforms
- Scaffolds

PeakWorks Advantage

- Fully automatic controlled descent
- Complete system, simple to use
- No power source or special skills required to operate

Escape-Rite® Accessories

PRODUCT NO.	MODEL NO.	Description	System Lengths
V855385	1000-DC000	Escape-Rite dust cover	10'-100' (3m to 30.5m)
V855383	1000-CONTNR	Weather-proof container	10'-300' (3m to 91.4m)



V85531-XX
1003-DEVXXX



V855385
1000-DC000



V855383
1000-CONTNR



ENGINEERED SYSTEMS

Permanent Horizontal Lifelines

Permacable® Systems

The PeakWorks Permacable® system is pre-engineered, synthetic cable designed for horizontal lifeline applications. It is lightweight, strong, and has an excellent resistance to weather and chemicals. The synthetic cable reduces the forces transferred to the anchorage. Permacable® meets all recommended OSHA requirements for horizontal lifelines and can span up to 200' without intermediate supports, unlike traditional steel cable which require supports every 30' to 50'. It can support up to two workers at a time. A special red inspection liner in the cable alerts the user to wear or damage.

- Lightweight; only 15 lbs. per 100'
- Strong tensile strength 16,000 lbs.
- Spans up to 200' between anchorage and weighs only 15 lbs. per 100'
- Low anchorage points forces
- Low sag
- High chemical and wear resistance
- Adjustable length allows for use in permanent or semi-permanent applications.
- Special red liner alerts user to wear or damage. Allows up to four workers.
- Variety of prefabricated anchor points, posts and inverted L's are available.
- Meets **OSHA 1910.66, 1926 subpart M**
- Made in the USA

Temp HLL (Temporary Horizontal Lifeline)

Temporary, polyester rope horizontal lifeline system with bucket storage

Features

- Temporary, polyester rope horizontal lifeline that is ideal for electrical, built-up-scaffolding, tanks, vessels and catwalks.
- Low anchorage forces
- High strength, chemical resistant polyester rope lifeline
- Quick set-up and disassembly
- Continuous protection
- Spans up to 150' for one or two workers
- Three-strand polyester rope allows easy inspection of inner fibers
- Rope vise makes tensioning easy
- One system can be used for many different spans
- Meets OSHA and ANSI standards

Specifications

- Type: Polyester Rope Horizontal Lifeline Kit
- Length: 30' to 100'
- Standards: Meets **OSHA 1910.66, 1926 subpart M**
- Made in the USA

PRODUCT NO.	MODEL NO	Description
V865321	9450-BW030BG	30' Beamwalker Kit in a Bag
V865324	9450-BW050BG	50' Beamwalker Kit in a Bag
V865327	9450-BW075BG	75' Beamwalker Kit in a Bag

Give Us a Call for Your Turnkey Engineered Systems



PEAKWORKS™

TOOL TETHERING SYSTEM

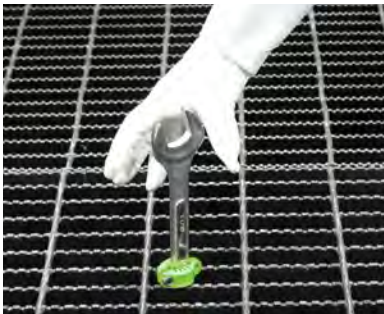

PEAKWORKS TOOL COLLAR

A Complete Tool Tethering Safety System!

- PeakWorks introduces the patented Tool Collar tool tethering system, designed to protect workers from tools dropped at height
- Developed and manufactured in Canada, the Tool Collar system offers a unique tool attachment product that provides the strongest, most secure tool anchor clamping mechanism in the market
- The high-strength HDPE clamps can be securely mounted onto a wide variety of flat, hex, and round shaped tool bodies, ensuring a powerful and positive tether anchor point
- HDPE materials work in both extreme cold and high heat applications and are very durable and long lasting
- The clamps are secured using high-strength fasteners and are easily installed and removed using the hex key wrench provided in the kit
- Unlike traditional heat-tape anchoring systems, our clamps can be reused and/or repositioned at any time — a true cost saving system
- **Bonus** — Tool Collar anchor clamps have been specially designed to prevent tools from falling through commonly used construction site grating (19-4)
- No other tool tethering program offers this added safety feature!
- All Tool Collar anchor clamps feature a strong, molded eye hole for quick attachment to/ detachment from wrist or standard lanyards with built-in carabiners
- Currently there are no ANSI or CSA standards for tool tethering systems; however, all Tool Collar products were subjected to an extreme and rigorous series of tests at CSA's test lab to ensure maximum peace of mind and safety
- All Tool Collar anchor clamps are available in individual blister packs or 10-piece bulk packs (five bulk packs — 50 pieces per box)

Tool Collar Round Clamp

- Designed for use with round and hex shank tool bodies
- Available in four sizes: 1/2", 5/8", 3/4" and 7/8"

PRODUCT NO.	MODEL NO.	Type	Size	Package Qty.
V8561101	TT-1000-1	Round	1/2"	1 Piece (Blister)
V8561102	TT-1000-10	Round	1/2"	10/Box, 50/Carton*
V8561201	TT-2000-1	Round	5/8"	1 Piece (Blister)
V8561202	TT-2000-10	Round	5/8"	10/Box, 50/Carton*
V8561301	TT-3000-1	Round	3/4"	1 Piece (Blister)
V8561302	TT-3000-10	Round	3/4"	10/Box, 50/Carton*
V8561401	TT-4000-1	Round	7/8"	1 Piece (Blister)
V8561402	TT-4000-10	Round	7/8"	10/Box, 50/Carton*

Tool Collar Flat Clamp

- Designed for use with wide or flat tool bodies
- Available in two sizes: 15/16" W x 5/16" H (small) and 1-15/16" W x 9/16" H (large)
- Small flat clamp fits a range of wrenches of approximately 7/16" to 1-1/4"
- Large flat clamp fits a range of larger wrenches approximately 1-1/4" to 1-7/8"

PRODUCT NO.	MODEL NO.	Type	Size	Package Qty.
V8561501	TT-5000-1	Flat	15/16" x 5/16"	1 Piece (Blister)
V8561502	TT-5000-10	Flat	15/16" x 5/16"	10/Box, 50/Carton*
V8561601	TT-6000-1	Flat	1-15/16" x 9/16"	1 Piece (Blister)
V8561602	TT-6000-10	Flat	1-15/16" x 9/16"	10/Box, 50/Carton*

Tool Collar Press Block

- Designed for use with round and hex shank tool bodies and larger tools
- Available in two sizes: 1/2" to 3/4" and 1-1/16" to 1-1/4"
- Comes with standard hex-shaped opening and includes a separate rubber insert that can be placed between the tool and the clamp for extra sizing compatibilities and increased clamping grip

PRODUCT NO.	MODEL NO.	Type	Size	Package Qty.
V8561701	TT-7000-1	Press block	1/2" to 3/4"	1 Piece (Blister)
V8561702	TT-7000-10	Press block	1/2" to 3/4"	10/Box, 50/Carton*
V8561801	TT-8000-1	Press block	1-1/16" to 1-1/4"	1 Piece (Blister)
V8561802	TT-8000-10	Press block	1-1/16" to 1-1/4"	10/Box, 50/Carton*

Tool Collar Lanyards

- The PeakWorks Tool Collar tethering system includes two specially designed lanyards that connect the tool anchor clamp to either the operator or to a suitable anchor point
- The wrist lanyard features a built-in heavy duty adjustable wrist collar on one end and a small carabiner on the other, conveniently tethering the tool to your wrist
- The standard lanyard features two small carabiners designed to connect to the tool anchor clamp and the other end to operator (or a suitable anchor)
- The small carabiner is designed to fit into the molded eye hole built-in to each of the Tool Collar HDPE clamps and is used to tether the tool to your body or to a suitable fixed anchor
- Both lanyards can also be used and mounted to variety of other tools in the market that feature hanging hole openings (i.e., adjustable wrenches and pipe wrenches)
- Tool Collar lanyards are designed for use with tools with a maximum weight of 15 lbs. Do not exceed this weight limitation

PRODUCT NO.	MODEL NO.	Type	Size (unstretched)	Package Qty.
V856210	TT-9900	Wrist	13"	1 Piece c/w Hang Card
V856211	TT-9900-10	Wrist	13"	10/Box, 50/Carton*
V856220	TT-9901	Standard	32"	1 Piece c/w Hang Card
V856221	TT-9901-10	Standard	32"	10/Box, 50/Carton*
V856230	TT-9902	Slim line no locking carabiners	22.5"	1 Piece c/w Hang Card
V856231	TT-9902-BULK	Standard	13"	10/Box, 50/Carton*
V856240	TT-9903	Slim line with locking carabiners	22.5"	1 Piece c/w Hang Card
V856241	TT-9903-BULK	Slim line with locking carabiners	22.5"	10/Box, 50/Carton*
V856250	TT-9904	Slim line with loop & locking carabiner	28"	1 Piece c/w Hang Card
V856251	TT-9904-BULK	Slim line with loop & locking carabiner	28"	10/Box, 50/Carton*

*Please note: All Tool Collar products are available individually, or in bulk 10 packs which are then master-packed five packs (50 pieces) per carton. Save by purchasing in both 10-packs and master packs of 50.





V890252
Tool Tether Display

Tool Tether Display

- Everything you need to get started with the new Tool Tethering System
- Designed for use on peg board or slot wall
- Modular design allows for additional merchandisers to be incorporated as needed
- 2' x 2' (70cm x 70cm) footprint that takes up less space than conventional displays
- Sets up in minutes — tool tethers, hardware, and graphics all included

PRODUCT NO.	Description	Qty.
V8561101	TT-1000-1 Round Clamp 1/2"	4
V8561201	TT-2000-1 Round Clamp 5/8"	4
V8561301	TT-3000-1 Round Clamp 3/4"	4
V8561401	TT-4000-1 Round Clamp 7/8"	4
V8561501	TT-5000-1 Flat 15/16" x 5/16"	4
V8561601	TT-6000-1 Flat 1 5/16" x 9/16"	4
V8561701	TT-7000-1 Press 1/2" to 3/4"	3
V8561801	TT-8000-1 Press 1 1/16" to 1 1/4"	3
V856210	TT-9900 Wrist Lanyard	3
V856220	TT-9901 Standard Lanyard	3









ANSI Standards

Z359.11-2014	Safety Requirements for Full Body Harness
Z359.13-2013	Personal Energy Absorbers Energy Absorbing Lanyards
Z359.14-2012	Safety Requirements for Self Retracting Devices for Personal Fall Arrest Systems and Rescue Systems
Z359.15-2014	Safety Requirements for Single Anchor Lifelines and Fall Arrester for Personal Fall Arrest Systems
Z359.12-2009	Connecting Components for Personal Fall Arrest Systems
Z359.1-2017	Safety Requirements for Anchorage Connectors for Active Fall Protection Systems

CSA Standards

CSA Z259.1-05 (R2010)	Safety Belts and Saddles for Work Positioning and Travel Restraint
CSA Z259.2.2-17	Self-Retracting Devices for Personal Fall-Arrest Systems
CSA Z259.2.3-16	Descent Control Devices
CSA Z259.2.4-15	Fall Arrester and Fixed Rigid Rails
CSA Z259.2.5-17	Fall Arresters and Vertical Lifelines
CSA Z259.10-18	Full Body Harness
CSA Z259.11-17	Energy Absorbers and Lanyards
CSA Z259.12-16	Connecting Components for Personal Fall Arrest Systems
CSA Z259.13-16	Flexible Horizontal Lifelines
CSA Z259.14-12	Fall Restrict Equipment for Wood Pole Climbing
CSA Z259.15-12	Anchorage Connectors
CSA Z259.17-16	Selection and Use of Active Fall-Protection Equipment and Systems

OSHA REGULATIONS GOVERNING CONSTRUCTION (29 CFR PART 1926)

Subpart E covers various requirements for personal protective equipment.

Safety Belts, Lifelines and Lanyards	1926.104
Safety Nets	1926.105

Subpart L covers Scaffolds. 1926.450-454

Subpart M covers fall protection fully, including when and where fall protection systems are required and for what construction work activities. It also defines system component requirements.

Scope, Application and Definitions	1926.500
Duty to Have Fall Protection	1926.501
Fall Protection Systems Criteria and Practices	1926.502
Training Requirements	1926.503

Subpart X covers Ladders 1926.1053

OSHA REGULATIONS GOVERNING GENERAL INDUSTRY (29 CFR PART 1910)

Subpart D mentions a few specific Fall Protection requirements relative to walking/working surfaces.

Fixed Ladders, Ladder Safety Devices	1910.27(d)(5)
Safety Requirements for Scaffolding, Boatswain's Chairs	1910.28(j)(4)

Subpart F covers fall protection as it pertains to powered platforms, man lifts, and vehicle mounted work platforms.

Maintenance	1910.66
Personal Fall Arrest Systems	1910.66

Subpart J covers general environmental controls in which confined spaces are addressed.

Confined Spaces	1910.146
-----------------	----------

ANSI STANDARDS GOVERNING CONSTRUCTION AND DEMOLITION OPERATIONS

Safety Requirements for Personal Fall Arrest Systems, Subsystems and Components	Z359.1-2007
---	-------------

AMERICAN NATIONAL STANDARDS INSTITUTE, INC. (ANSI)

11 West 42nd Street
 New York, NY 10036
www.ansi.org

INDEX

37 96, 103, 171	430P 42, 43, 48	5626U 222	7704 226
54 PC 55	437 96, 101, 171	5627U 222	7704T 226
82 B 101, 171	451P 42, 48	5628U 222	9450-BW030BG 308
82 BM 101	490P 42, 48	5629U 222	9450-BW050BG 308
87 Mounting	577AU 218	5670U 217	9450-BW075BG 308
Blades 48, 101, 171	597U 208	5999AU 217, 229	9900-TROLLEY6 283
117A 48	598U 208	5999PU 217, 230	9900-TROLLEY6A 283
117A Replacement	695 NPR Winterliner 173	6672U 204	12978 174, 175
Headgear 37, 42, 43	810 Series 137	6673U 204	13821 149
131-B 100	812 Series 137	6674U 204	13822 150
131BBAU 206	813 Series 137, 138	6675U 204	14132 107
134BBAU 206	830 Series 137, 138	6690U 212, 229	14200 86, 87
134NAU 206	832 Series 137, 138	6691U 212	14201 86, 87
135AU 206, 228	860P 37	6692AU 203	14202 49, 87, 105, 170, 171
136U 202	880 Series 136	6693AU 203	14203 49, 87, 105, 170, 171
137 96, 102, 171	881 Series 136	6730U 203	14214 87
139PKU 202	882 Series 136	6731U 203	14215 87
139U 202	900 Series 15	6790U 212	14220 80, 81
145U 212	930P 43, 48	6791U 212	14225 49, 81, 105, 171
170-SB 96, 100, 110	951P 43, 48	6844U 210	14230 80, 81
182 B 102	990P 48	6845U 210	14233 80, 81
182-B 171	1000-CONTNR 307	6853U 210	14235 49, 80, 81, 105, 170, 171
187-S Mounting Blades . 41, 48	1000-DC000 307	6854U 210	14238 49, 81, 105, 170, 171
225 Plus Winterliner 172	1003-DEVXXX 307	6855U 210	14250 81
280 51	1006-DEVXXX 307	6856U 210	14255 81
280 Series 15, 38, 45, 51, 104	1127 Filter Lens 54	6882U 214	14258 81
282-B 96, 102, 171	4118 110	6883U 214	14260 49, 98, 99, 105, 107, 108, 170
290 Series 15, 38, 46, 51, 104	4178 110	6887U 215	14262 49, 98, 99, 105, 109, 170
301 Series 97, 110, 141	4199 110	6888U 215	14350 111
303 Series 97, 141	4400-BA1CKTS 288	6901AU 214	14355 111
305 TSL Winterliner 173	4456-KIT03S 289	6914AU 227	14356 111
311 Series 93	5040BBU 222	6916AU 227	14381 100, 109
312 Series 94, 95	5041BBU 222	6921U 208	14390 102, 171
325 Ultra Winterliner 172	5208AU 225	6922U 208	14391 102, 171
337 103, 171	5209U 223	6924AU 216	14393 103, 171
337SFU 226, 228	5400AU 221	6925AU 216	14407 166
338SFU 226	5400HU 221	6930U 206	14409 166
370 Speed Dial 2, 3, 13, 15, 21, 23, 25, 28, 30, 31, 80, 81, 86, 87, 96, 98, 99, 109, 160, 161, 164	5401AU 221	6931U 206	14416 166
380 Series 88, 89, 90, 93, 104, 141, 171	5401HU 221	6935AU 206	14418 166
382-B 96, 171	5404AU 221, 230	6936AU 206	14420 166
386 Cap Adapter 48	5405AU 221	6937AU 206	14423 166
390 Series 91, 92, 93, 104, 141, 171	5408AU 224	6940U 216	14425 170
400 Series 15	5409AU 224	6941U 216	14426 166
400 Ultra Winterliner 173	5496U 213	6960U 208	14429 161, 166, 167, 169
411P 42, 48	5497U 213	6961U 208	14434 166, 167
427 Filter Lens 54	5591U 213	6990U 214, 229	14445 108
	5592U 213	6991U 214	14459 169
	5598U 219	6995U 215	14494 172
	5599U 219	6996U 215	
	5618U 219	7702 226	
	5619U 219	7702T 226	

INDEX

14495 172	14773..... 61	14961..... 48	20202 163
14496 172	14774..... 61	14972..... 40	20203 163
14497..... 172	14775..... 61	14973..... 41	20204 163
14499 172	14776..... 61	14975..... 41	20205 163
14501..... 173	14777..... 62	14976..... 41	20220 163
14502 172	14778..... 61	14977..... 41	20221 163
14504 173	14779..... 62	14978..... 41	20222 163
14505 103, 171	14780..... 61	14979..... 40	20223 163
14506 101, 171	14781..... 61	14982 40	20224 163
14527..... 42	14782..... 61	14986 40	20225 163
14528..... 42	14783..... 61	15121..... 40	20230 163
14529 42	14785..... 62	15132..... 40	20232 163
14531..... 37	14786..... 62	15134..... 41	20392 167
14532 42	14795..... 63	15968 41, 48	20393 167
14534 43	14796..... 62	15973..... 48	20394 167
14535 43	14797..... 63	15974..... 41, 43, 56	20395 167
14556 37, 42, 43	14798..... 63	15975..... 56	20397 167
14559 54	14809 168	15977..... 31	20398 167
14560 40, 43, 54	14811..... 168	15978..... 31	20401 167
14561..... 54	14812..... 168	15984 31	20403 167
14562 54	14813..... 168	16058 56	20422 167
14563 41, 43, 54	14814..... 168	16063 56	20508 41
14564 54	14815..... 168	16068 56	20600 160
14566 54	14816..... 168	16073 37, 40, 42, 43, 55	20620 160
14570..... 54	14833 164	16078 41, 43, 55	20630 160
14571..... 54	14834 164	16150..... 159	20693 23, 27
14679..... 59	14836 164	16250 159	20694 81
14680 59	14838 164	16622 31	20695 87, 99
14681..... 59	14839 164	16642 41, 55	20696 ... 28, 30, 31, 40, 41, 48
14682 59	14841..... 164	16750..... 171	20697 161
14683 59	14842 164	16756..... 172	20698 161
14684 59	14843 164	16760..... 173	20699 161
14730..... 58	14936 164	16767..... 173	20701 161
14731..... 58	14937..... 161, 164	16797..... 109, 159, 171	20702 161
14732..... 58	14938 164	16799 109	20703 161
14733..... 59	14939 48, 101, 171	16800 109	20718..... 161
14734..... 59	14940 100	17330..... 169	20738 161
14742..... 59	14941..... 101, 171	18428 168	20771 154
14745..... 59	14942 102, 171	18446 161, 166, 167	20772 154
14746..... 58	14943 102, 171	19500 169	20773 152
14748..... 58	14944 101, 171	19502 169	20774..... 148, 152, 171
14752..... 63	14945 103, 171	20186 168	20775 152
14753..... 63	14946 103, 168, 171	20187..... 168	20776 109, 152, 155, 159
14754..... 63	14947..... 101, 171	20188 168	20777 109, 152, 155, 159
14756..... 63	14948 102, 171	20189 168	20778 109, 152, 155, 159
14763..... 63	14949 101, 171	20191..... 168	20800 162
14764..... 63	14951..... 101	20192..... 168	20801 162
14766..... 63	14952 102	20193 168	20802 162
14767..... 63	14955 100, 141	20194..... 168	20803 162
14771..... 61	14957..... 100, 141	20200 163	20804 162
14772..... 61	14958 100	20201 163	20805 162

INDEX

20820	162	28766	108	34068	41	36320	73
20821	162	28962	107	36144	71	36333	68
20822	162	28963	107	36145	71	36335	68
20823	162	29051	100, 109	36146	71	36336	68
20824	162	29052	108	36147	71	36338	68
20825	162	29053	108	36148	71	36364	71
20830	162	29054	108	36149	71	36687	66
20831	163	29055	109	36150	71	37192	71
20832	160, 162	29056	108	36151	71	37198	68
20900	159	29057	107	36152	72	37454	66
20901	159	29058	108	36153	72	37592	72
20903	159	29059	108	36154	72	37606	66, 68
20906	159	29060	108	36155	72	37607	66, 68
20907	159	29062	107	36156	72	37609	71
20920	158	29075	108	36157	72	37700	66, 68
20921	158	29076	100, 108	36158	73	38423	49, 81, 105, 170
20923	158	29077	100	36159	71	38424	49, 87, 99, 105, 170
20926	158	29078	108	36160	71	38425	49, 96, 101, 105, 107, 108, 170
20927	158	29079	108	36161	71	38426	28, 30, 48, 49, 105, 170
20930	159	29080	98, 108	36162	71	39476	49, 105, 170
20931	159, 160, 162	29081	109	36163	71	39477	49, 96, 105, 170
20932	159	29082	108	36164	72	41589	30
20933	159, 171	29083	108	36165	73	41594	30
20936	159	29084	108	36166	72	46101	30
20937	159	29085	108	36167	71	46118	28
21000	134, 135	29086	108	36171	71	46128	30
21001	134, 135	29087	98, 99, 107, 109	36173	72	46129	30
21002	134, 135	29088	108	36174	72	46130	30
22606	31	29089	108	36208	73	46131	30
23286	31	29090	108	36277	66	46138	30
23440	31	29091	108	36278	66	46148	31
23442	31	29092	100	36281	66, 68	46149	31
23475	142	29096	107	36283	66, 68	46151	31
24523	40	29097	107	36287	68	46152	31
24528	42	29098	107	36289	66	46158	28
24530	42	29099	107	36290	71	46159	28
24550	41	29100	107	36291	73	46163	28
24551	42	29101	107	36292	66, 68	46200	15, 17, 19
24557	37	29102	109	36293	71	46240	15, 27
24565	42	29103	107	36296	66, 68	46250	15, 23
24734	55	29104	107	36299	66, 68	46410	53, 56
24737	41	29106	98, 107	36302	72	46411	51, 56
25708	149	29107	107, 168	36304	66	46442	25, 27
25709	149	29109	107	36305	71	46452	21, 23
25973	109	30320	28	36306	73	46540	27
26035	37	30321	28	36307	66, 68	46550	23
26262	108	30590	31	36308	71	46600	19
28633	108	30706	98, 107	36312	66, 68	46640	27
28634	108	31202	95	36313	73	46910	53
28764	107, 168	32187	23, 27, 28, 30, 31, 40, 41, 81, 87, 99	36315	66, 68		
28765	106, 107, 168			36318	72		

INDEX

46911..... 51	AA-7 Windgard..... 172	CH-400V... 157, 158, 159, 171	87, 88, 89, 90, 91, 92, 93, 94,
46914..... 27	AA-8 Windgard..... 172	Charger..... 17, 48, 101, 102,	95, 96, 97, 98, 99, 100, 101,
46915..... 23	AA-9 Windgard..... 172	103, 157, 167, 171	102, 103, 104, 105, 106, 107,
46923..... 27	ABC-DISPLAY..... 297	Chin Cup..... 107, 108	108, 109, 110, 134, 141,
46925..... 23	AC-6600..... 282	Compliance Series... 245, 256	155, 163, 164, 168, 170
46930..... 17, 19	AC-6600-48..... 282	Contractor Series... 245, 252,	FBH-1000L..... 255
46991..... 27	AC-6601..... 282	253, 254, 255	FBH-7011G..... 247
46995..... 23	AC-6604..... 282	CP-03015-1..... 295, 297	FBH-10000A... 245, 254, 290
50000..... 114, 115	AC-9450-SBAR..... 280	CP-03015-2..... 297	FBH10000A1020X..... 253
50001..... 114, 115	AC-9452-DTA..... 281	CP-04011-1..... 297	FBH-10000AHV..... 255
50002..... 114, 115	AC-9452-DTA-2..... 281	CP-10010-1..... 279	FBH-10000B..... 254
50003..... 115	AC-9452-DTA-4..... 281	CP-10010-2..... 279	FBH-10000E..... 255
50004..... 114, 115	AC-9452-DTA-5..... 281	CP-10011-1..... 279	FBH-10000L..... 255, 300
50005..... 114, 115	AC-9452-DTA-6..... 281	CP-10011-2..... 279	FBH-10002A..... 245, 256,
50006..... 114, 115	AC-9452-DTA-7..... 281	CP-10011-3..... 279	286, 287, 290
50007..... 115	AC-9452-DTA-8..... 281	CP-11010-1..... 280	FBH-10020A... 254, 290, 291
50008..... 114, 116	AC-9900-TROLLEY7..... 280	CP-11010-3..... 280	FBH10020A1020X..... 253
50009..... 114, 115	Acetate..... 90, 96, 100,	CP-12010-1..... 281	FBH-10020B..... 254, 291
50010..... 114, 116	106, 108, 110	CP-12010-2..... 281	FBH-10020E..... 254
50011..... 115	ADF..... 8, 9, 10, 11, 13, 15,	CP-14010..... 258	FBH-10022A..... 256, 287
50012..... 115	17, 19, 21, 23, 25, 27, 28,	CP-15300-3..... 294	FBH-60110A..... 250
50013..... 115	30, 31, 32, 33, 34, 51, 55	CP-23300-1..... 259	FBH60110A10201..... 249
50014..... 115	Advantage..... 13, 97, 157, 171	CP-41210-3..... 294, 297	FBH60110A10202..... 249
50015..... 115	Advantage Plus	CSK1-60..... 293	FBH60110A10203..... 249
50016..... 115	Series..... 33, 122	CSK2..... 293	FBH60110A10204..... 249
50017..... 116	Advantage Series... 17, 31, 34,	CSK2-60..... 293	FBH60110A10205..... 249
50018..... 116	97, 122, 124, 125,	CSK2-65..... 293	FBH-60110APL..... 250
50025..... 117	154, 162, 163, 180	CSK3-60..... 292, 293	FBH-60110B..... 250
50026..... 117	Arc Angel..... 28, 30	D	FBH-60110L..... 251, 300
50027..... 117	AS-21000-X..... 282	Davit Arm System..... 296	FBH-60120A..... 251
50028..... 117	AS-21110-X..... 282	Disposable Dust Mask... 174	FBH-60120B..... 251
50029..... 117	Auto Darkening Filter... 9, 12,	DP4..... 82, 83, 84, 85,	FBH-70110A..... 247
50030..... 117	27, 51, 53, 54	104, 141, 171	FBH-70110B..... 247
50031..... 117	B	Drybrow..... 171	FBH-70110G..... 244, 247
50040..... 114, 116	B5..... 127	DSK3-60..... 296	FBH-121102B..... 257
50041..... 114, 116	BAG-001..... 290, 291, 297	Dual Compact SRD-LE... 266	FBH-PAD..... 258
50042..... 114, 116	BAG-004..... 297	Dual Tie-Back LE..... 264	Fiber Shell..... 42, 43
64230..... 174, 175	BAG-005..... 294, 297	F	Fibre-Metal..... 110
64235..... 174	BAG-006..... 297	F4XP... 3, 49, 96, 98, 99, 105,	FK-005..... 290
64240..... 174, 175	Black..... 28, 30, 41	107, 108, 109, 110, 141, 170	FK-006..... 291
64420..... 174, 175	Black Strap..... 186, 187	F10 Face Shield.. 98, 106, 107	FK-007..... 291
64520..... 174, 175	Blockhead..... 3, 17, 103, 161	F20 Face Shield..... 98, 100,	FK-008..... 291
67210..... 149	Blockhead FG..... 3, 157,	106, 107	FK-009..... 291
67212..... 148, 149	160, 171	F30 Face Shield..... 98, 100,	FK-010..... 290
67220..... 148, 150	Blockhead II..... 157, 171	106, 108	FK-011..... 290
67221..... 150, 151	C	F40 Face Shield.. 98, 106, 108	Flash-Tex Liners..... 173
79103..... 125	C10..... 157, 168, 171	F50 Face Shield.. 98, 106, 108	G
79108..... 125	CableGrab..... 301	F60 Face Shield..... 106, 109	GM200..... 135
A	Carbon Fiber..... 41, 160	F60 Wire Mesh..... 106, 109	GM500..... 135
A-5500SN..... 103, 171	CAS4..... 282, 287	Face Shield..... 3, 17, 27,	GPL500..... 135
A-5500X..... 101, 171	CH-300..... 157, 159, 171	49, 80, 81, 82, 83, 84, 85, 86,	GPL530..... 135

INDEX

GPL550 135	Leather 15, 37, 38	R	S22448 136, 137
Guest-Gard 125	Light Seal Gasket 55	R05 Disposable	S22450 38
H	M	Dust Mask 174, 175	S23400 154
H10 Disposable	Mag Lens Holder 56	R10 Respirator 174, 175	S23401 154
Earplugs 149	Max Light 89, 90	R20 Respirator 174, 175	S23403 148, 153
H70 152, 154, 155, 159, 171	Maxview 3, 49, 86, 87, 105,	R30 Respirator 174, 175	S23404 153
H225 154	125, 141, 170, 171	RA-100 274	S23406 153
Halo X 15, 30, 31, 41, 48, 170	Merch. Torso 297	RAS4 282, 287	S23407 153
Hard Hat 3, 28, 30, 31,	MFS-320 111, 141	RB-9701 279	S23409 155, 171
40, 41, 48, 49, 80, 81, 83, 85,	Mid-Sole Model 186	RB-9800 279, 286, 287	S23410 148, 149
94, 96, 101, 102, 103, 104,	Model C 102, 171	RB-9900 279	S23411 149
105, 107, 108, 109, 110, 155,	Model H 171	Rebel 15, 17, 19	S23412 149
157, 158, 159, 160, 162, 163,	Model K 96, 100, 110	Respirators 174	S23413 149
164, 166, 167, 170, 171, 173	Model P 102, 171	Res-Q-Kit 295	S23414 149
Heavy Metal 41	MW-65 292, 294, 296	Res-Q-Pole w/	S23420 150
HLX 13, 15, 28, 30, 31, 41, 48	MW-65G 292, 293, 294	Res-Q-Head 295	S23421 150
HLX-100 3, 41	N	RFID-1 297	S23422 150
HP424 153	N95 Particulate	RG-11005 277	S23430 151
HP427 153	Respirator 174, 175	RG-11015 277	S23431 151
HP431 153	N99 Particulate	RG-12142 286, 287	S23469 142
HPD425 153	Respirator 174, 175	RK6 286	S23470 142
HPS428 155	NexGen 3, 12, 13, 31, 41	RK7 286, 287	S23480 142
H Series 48	Nitro 48, 170	S	S23490 142
HSL 13, 15, 28, 30,	Nomex 173	S16604 54	S25000-10 39
31, 40, 41, 48, 170	O	S16605 54	S26100 13, 34
HSL-1 3, 15, 40, 48, 51, 53	Odyssey II 130, 131,	S16606 54	S26200 13, 33
HSL-2 3, 15, 40, 48, 51, 53	132, 133, 139	S16609 54	S26400 13, 32
HSL-100 3, 41, 48	Old Firebird 124	S16610 54	S27000 38
HSL Series Shadow 48	OTG 124, 125	S16611 54	S27001 38, 46
I	P	S16612 54	S27005 34
I ² 30	P95 Particulate	S16709 54	S27006 32, 33
Insight 3, 12, 13, 30, 41	Respirator 174, 175	S16710 54	S27051 38, 88, 89,
Intrinsic 186, 187, 188	PeakPro 250, 251, 258	S16711 54	90, 91, 92, 93
Iron Mask 39	PeakPro Plus	S16712 54	S27710 34
IRUV 96, 106, 108, 135	Series 244, 246, 247	S18100 56	S27720 33
K	PeakPro Series 244, 248,	S18125 56	S27740 32
K1MID 186, 187	249, 250, 251	S18150 56	S28301 45
K1MID-BLK 186, 187	PETG 96, 106, 107, 168	S18175 56	S28311 45
K1MID-HP 186, 187	Polycarbonate 54, 81,	S18200 56	S28501 45
K1MID-HP-BLK 186, 187	82, 84, 85, 86, 87, 88, 89, 90,	S18225 56	S29301 46
K1MID-INT 186, 187, 188	91, 92, 93, 94, 95, 96, 97, 99,	S18250 56	S29311 46
K1MID-INT-HP 186, 187, 188	100, 106, 107, 108, 110, 114,	S19002 55	S29341 46
K1MID-INT-LP 186, 187, 188	118, 120, 122, 124, 126, 127,	S19004 55	S29371 46
K1MID-LP 186, 187	130, 134, 135, 136, 137	S19451 34	S29411-08E 38
K1MID-LP-BLK 186, 187	Polypropylene 49, 105	S19452 33	S29901 46
K1MID-SLM 186, 187, 189	Proban 173	S19454 32	S29911 46
L	Professional Variable 41	S21100 38	S30100 96, 97
LAN-1222-X 274	Propionate 96, 106, 108	S21300 38	S30110 97
LAN-1242-X 274	Q	S21301 38	S30120 97
LAN-3400-X 274	Quad 500 3, 49, 80, 81,	S21301-10 38	S30310 97
LAN-3402-X 274	105, 141, 170, 171	S22185 143	S31200 94, 95

INDEX

S31201	95	S36000	90	S70704	126	S76301	125
S31220	95	S36020	90	S70705	126	S76341	125
S31222	95	S36040	90	S70711	124	S76361B	125
S31223	95	S36050	90	S70721	124	S76371	125
S31224	95	S37040	110	S70731	124	S76701	125
S32000	85	S37050	110	S71100	122	S76771	125
S32001	85	S37599	97	S71101	122	S79100	124
S32003	85	S37600	110	S71102	122	S79301	125
S32010	82, 83, 84, 85	S37601	110	S71200	122	S79302	125
S32011	84, 85, 95	S37606	110	S71201	122	S79371	125
S32012	84	S37607	110	S71202	122	S79372	125
S32030	82, 84, 85	S37608	110	S71203	122	S79901	126
S32032	84	S37701	110	S71400	123	S79904	126
S32050	82, 84, 85	S38110	88, 89	S71401	123	S79905	132
S32052	84, 85	S38140	88, 89	S71402	123	S79906	132
S32100	85	S38150	88, 89	S71910	118, 119	S80200	130, 131
S32130	85	S38210	90	S71911	119	S80201	130, 131
S32150	85	S38230	90	S71912	119	S80202	130, 131
S32151	83, 84, 85	S38240	90	S72000	120	S80203	130, 131
S32152	85	S38250	90	S72001	120	S80210	130, 132, 139
S32153	85	S38410	88, 89	S72002	120	S80211	130, 132
S32155	85	S38440	88, 89	S72100	121	S80225	133
S32161	84, 85	S38510	90	S72101	121	S80226	133
S32161B	84, 85	S38540	90	S72102	121	S80231	130, 131
S32162	85	S39000	93	S72300	120, 121	S80245	132
S32162B	85	S39010	92	S72301	121	S80246	131
S32163	85	S39020	92	S72302	121	S80251	131
S32163B	85	S39040	92	S72400	121	S80290	131
S32166	85	S39050	92	S72401	121	S81000	137
S32166B	85	S39100	93	S72402	121	S81010	137
S32181	83, 84, 85	S39110	91, 92	S72903	127	S81200	137
S32182	85	S39120	92	S72905	127	S81210	137
S32183	85	S39140	91, 92	S73401	124	S81210E	137
S32188	85	S39150	91, 92	S73402	124	S81220	137
S32200	83, 85	S39200	93	S73421	124	S81220X	137
S32210	84, 85	S39210	92	S73471	124	S81310	138
S32212	84	S39240	92	S73481	124	S81320	138
S32251	83, 84, 85	S39250	92	S73601	123	S81330	138
S32252	85	S61600	104, 171	S73611	123	S82000	135
S32261	82, 84, 85	S61601	96, 104, 171	S73621	123	S82500	135
S32262	85	S61602	104, 171	S73631	123	S83000	138
S32281	83, 84, 85	S61610	95, 104, 171	S73801	125	S83010	138
S32282	85	S61900	96, 104, 171	S73802	125	S83200	138
S35000	93	S61970	38, 46, 84, 85, 88, 90, 93, 94, 95, 104, 171	S74201	123	S83210	138
S35020	93	S69500	95	S74202	126	S85110	139
S35040	93	S70000	119	S74203	126	S85150	139
S35050	93	S70001	119	S74204	126	S85250	139
S35100	93	S70002	119	S74241	123	S85350	139
S35120	93	S70701	124	S74271	123	S85450	139
S35140	93	S70703	126	S74701	127	S85550	139
S35150	93			S74751	127	S85560B	139

INDEX

S88000	136	SA-7405-6U	273	13, 15, 25, 27	V85025	293	
S88003	136	SA-7500-6U	273	Trauma Straps	251, 259	V85026	292, 293
S88010	136	SA-7502-6U	273	Trident Series	38	V85043	296
S88110	136	SA-84000-6U	273, 291	TrueSight II	3, 12, 13, 28, 41	V85531-XX	307
S88200	136	SA-84022-6U	273, 291	TT-1000-1	311, 312	V85532-XX	307
S88210	136	SA-85522-6U	273	TT-1000-10	311	V254031T	226
S90306	144	Safe 2 Protection		TT-2000-1	311, 312	V254035T	226
S90315	145	System	109, 158, 159, 171	TT-2000-10	311	V800517X	247, 294
S90320	144, 145	SC-6	3, 17, 48, 49, 101,	TT-3000-1	311, 312	V805101_	258
S90321	145		102, 103, 105, 107,	TT-3000-10	311	V805101X	258
S90322	144, 145		108, 157, 164, 170, 171	TT-4000-1	311, 312	V805601_	258
S90324	145	Sebring	125	TT-4000-10	311	V805601X	258
S90325	145	Sentry III	17, 48, 101, 102,	TT-5000-1	311, 312	V805602_	258
S90326	145		103, 157, 166, 171	TT-5000-10	311	V805602X	258
S90329	146	Shadow Series	15, 30, 31,	TT-6000-1	311, 312	V815100X	274
S90330	146		40, 41, 48	TT-6000-10	311	V815120X	274
S90331	146	Single SRD LE	267	TT-7000-1	311, 312	V820310X	282
S90332	146	Smartweld	51, 104	TT-7000-10	311	V820350X	282, 287
S90333	146	Solera II	53	TT-8000-1	311, 312	V820800X	282
S90335	145	SRL-54T54-9TB	265	TT-8000-10	311	V820860X	282
S90336	145	SRL-40302-12	269	TT-9900	311, 312	V820910X	282
S90479	141	SRL-40302-18	269	TT-9900-10	311	V820950X	282
S90482	141	SRL-50502-6LE	266	TT-9901	311, 312	V825521X	252, 253
S90484	141	SRL-50602-6LE	266	TT-9901-10	311	V825522X	253
S90486	141	SRL-53302-10LE	267	TT-9902	311	V830103	277
S90488	141	SRL-53302-20LE	268	TT-9902-BULK	311	V830113	277
S90494	140, 141	SRL-53302-30LE	268	TT-9903	311	V845552T009TB	265
S90495	141	SRL-53302-40LE	268	TT-9904	311	V855121	295
S90496	141	SRL-53302-60LE	268	TT-9904-bulk	311	V855130	294
S96110	178, 179	SRL-53302-120	269	U		V855383	307
S96110-6	180	SRL-53302-140	269	Ultra Flex III	178, 179, 180	V855385	307
S96110-7	180	SRL-53302-170	269	Universal	81, 83, 84, 85, 87,	V856210	311, 312
S96111	179	SRL-53303	293, 294		88, 90, 92, 94, 95, 96,	V856211	311
S96112	179	SRL-53303-060	270, 292		99, 101, 102, 103, 104,	V856220	311, 312
S96113	179	SRL-53303-96	270		106, 107, 108, 109, 110,	V856221	311
S96114	179	SRL-53303-140	270		141, 149, 150, 168, 171,	V856230	311
S96211	179	SRL-53303-BRKT	292, 294		173, 175, 242, 249, 250,	V856231	311
S96310	180	SRL-53402-10LE	267		251, 253, 254, 255, 288, 289	V856240	311
S96311	180	SRL-54854-7-5LE	266	V		V856241	311
S96350	180	SRL-54954-9TB	265	V8059	258	V856250	311
S96410	181	SRL-65105-6LE	267, 290	V8460	292, 294	V856251	311
S96411	181	Stars & Scars	28, 30	V81540X	274	V860001	297
S96412	181	T		V81542X	274	V860004	297
S96413	181	Tie-Back SRL-LE	265	V82235	283	V860005	294, 297
SA-1700-6	257	Titan Series	38, 104	V82236	283	V860006	297
SA-1702-6	257	Tonedown 200	154	V83010	277	V860120	295, 297
SA-7400-4U	273	Tool Tether Display	312	V84013XXX	276	V860121	297
SA-7400-6AU	273	TR-100	292, 293, 294, 297	V84014XXX	276	V860130	297
SA-7400-6U	273, 290	Translight+	8, 13, 15, 23	V84084XXX	276	V860140	274
SA-7402-6AU	273	Translight+ 555	3, 12, 13, 21	V85011	292, 294	V860151	274
SA-7402-6U	273, 291	Translight 455 Flip	3, 8, 12,	V85024	293	V860153	294, 297

INDEX

V860301	258	V1025150U	210	V2540310	226	V8006210	251
V860303	259	V1025160U	210	V2540350	226	V8008000	255
V860308	258	V1025250U	210	V2570450U	226	V8009010	257
V860402	297	V1025260U	210	V2570470U	226, 228	V8051011	258
V860901	297	V1030150U	212	V3010460U	218	V8051012	258
V860904	297	V1030550U	208	V3550170	194	V8051013	258
V865190	303	V1030560U	208	V3550270	193, 196	V8051014	258
V865191	302	V1040850U	213	V3550370	192	V8051015	258
V865192	301	V1040860U	213	V3550470	195	V8104300	273
V865193	302	V1041050U	213	V3550570	191	V8104304	273
V865195	302	V1041060U	213	V3550670	192	V8104306	273
V865196	302	V1051150U	214, 229	V3550870	192	V8104320	273
V865197	302	V1051160U	214	V3550970	192	V8104326	273
V865198	302	V1051250U	215	V3551270	196	V8104356	273
V865199	302	V1051260U	215	V3551370	196	V8104406	273
V865321	308	V1052160U	214	V4550150	196	V8104426	273
V865324	308	V1054050U	214	V4550250	196	V8108306	273
V865327	308	V1054060U	214	V4550350	196	V8108326	273
V865420	300	V1054250U	215	V4550650	196	V8108426	273
V865423	300	V1054260U	215	V4550850	196	V8109506	257
V865428	300	V1060351U	216	V8001000	245, 256, 287	V8109526	257
V865438	300	V1060360U	208	V8001200	256, 287	V8205505	282
V890252	312	V1060450U	208	V8002000	245, 254	V8205704	282, 287
V1010141U	203	V1060461U	216	V8002010	254	V8205705	282, 287
V1010151U	203	V1060550U	216	V8002020	255, 300	V8221111	279
V1010250U	204	V1060560U	216	V8002030	255, 294	V8221112	279
V1010260U	204	V1070160U	217, 229	V8002060	243, 248	V8221113	279
V1010450U	204	V1070360U	217, 230	V8002200	254	V8221114	279
V1010460U	204	V1070760U	217	V8002210	254	V8221115	279
V1011150U	203	V1080150U	219	V8002230	254	V8221121	281
V1011160U	203	V1080160U	219	V8005101	247	V8221131	280
V1020161U	206	V1080350U	219	V8005102	247	V8222120	281
V1020251U	206	V1080360U	219	V8005103	247	V8222130	280
V1020951U	206	V1081350U	222	V8005104	247	V8222138	280
V1021061U	206	V1081360U	222	V8005105	247	V8222150	280
V1021150U	206	V1082350U	222	V8005111	247	V8223140	281
V1021170U	206	V1082360U	222	V8005112	247	V8223142	281
V1021260U	206	V1120651U	222	V8005113	247	V8223144	281
V1021571U	206, 228	V1120661U	222	V8005114	247	V8223145	281
V1021580U	206	V1130460U	223	V8005115	247	V8223146	281
V1021840U	202	V1130560U	225	V8005170	244	V8223147	281
V1021850U	202	V1200251U	221	V8005171	247	V8223148	281
V1021860U	202	V1200261U	221	V8005172	247	V8229001	279
V1023550U	212, 229	V1200350U	221	V8005173	247	V8229100	279, 287
V1023560U	212	V1200360U	221	V8005174	247	V8229104	279
V1023950U	212	V1200451U	221, 230	V8005175	247	V8252306	290
V1023960U	212	V1200461U	221	V8006100	250	V8252316	291
V1024850U	208	V1210160U	224	V8006110	250	V8252326	291
V1024860U	208	V1210170U	224	V8006120	251, 300	V8252336	291
V1025050U	210	V2510850U	227	V8006160	250	V8252346	291
V1025060U	210	V2510860U	227	V8006200	251	V8252356	289

INDEX

V8252366	288	V8561802	311	V845528009TB	264, 265	WH30	13, 31
V8252406	290	V8651126	304	V845533010LE	267	WH40	48
V8252416	290	V8651153	304	V845533020LE	268	WHB	13, 15, 30
V8255621	249	V8651154	304	V845533030LE	268	WHM	13, 31
V8255622	249	V8651160	304	V845533040LE	268	WHP	13, 15, 30, 31
V8255623	244, 249	V8651161	304	V845533060LE	268	Windgard	172
V8255624	249	V8651162	304	V845533120	269	Wind Jammer IV	173
V8255625	249	V8651164	304	V845533140	269	Wire Mesh	
V8257272	286	V8651173	305	V845533170	269	Face Shield	106, 109
V8257275	286	V8651175	305	V845534010LE	267	X	
V8257282	287	V8651176	305	V845534060	270, 292, 296	X35	127
V8257285	287	V8651182	305	V845534140	270	X300	124
V8455277-5LE	266	V8651184	305	V845822006LE	267	X300RX	126
V8561101	311, 312	V8651185	305	VL-1115-X	276	X330	124
V8561102	311	V8651187	305	VL-1125-X	276	X350	124
V8561201	311, 312	V8651189	305	VL-1825-X	276	XM300	122
V8561202	311	V8651203	304	W		XM310	122
V8561301	311, 312	V82005805	282, 287	WB-1010-X	258	XM320	123
V8561302	311	V84088025	287	WB-6006	258	XM330	123
V8561401	311, 312	V84088050	287	WB-6010-X	258	XM340	123
V8561402	311	V84537065	294, 296	WB-6020-X	258	XM340RX	126
V8561501	311, 312	V84553496	270	Welding and Arc		XP420	121
V8561502	311	V85523100	295	Flash Harness	257	XP450	121
V8561601	311, 312	V845179065	292, 294, 296	Welding Helmet	3, 8, 12, 14,	XP460	121
V8561602	311	V845423012LE	269	15, 21, 23, 25, 27, 28, 30, 31,		XPS502	118, 119
V8561701	311, 312	V845423018LE	269	32, 33, 34, 37, 38, 39, 40, 41,		XPS530	119
V8561702	311	V845525006LE	266	42, 43, 46, 48, 49, 105, 170			
V8561801	311, 312	V845526006LE	262, 266	Western Outlaw	157, 169		





Our Family of U.S. Brands



800.323.7402
orders.usa@surewerx.com
surewerx.com/usa

PPEWELDING21

Be Smart. Be Safe. Be Sure.